

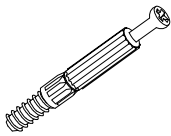

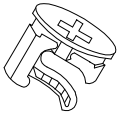





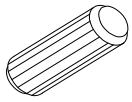
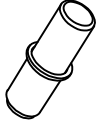

<p>4066</p>  <p>Ø6.5x36.5mm x12</p>	<p>3996</p>  <p>Ø15x12mm x12</p>	<p>136236</p>  <p>Ø20 x12</p>	<p>3989</p>  <p>Ø8x30mm x12</p>
<p>4017</p>  <p>x8</p>	<p>3879</p>  <p>Ø6.3x13mm x6</p>	<p>3923</p>  <p>Ø4,0x16mm x46</p>	<p>4044</p>  <p>x20</p>
<p>4057</p>  <p>x10</p>	<p>IN01112</p>  <p>H-20 mm x1</p>	<p>3884</p>  <p>x6</p>	<p>IN01032</p>  <p>x6</p>
<p>3984</p>  <p>4 mm x1</p>	<p>IN01007</p>  <p>x6</p>	<p>IN01006</p>  <p>x6</p>	<p>IN00378</p>  <p>L-2160 mm x1</p>
<p>71900</p>  <p>x2</p>	<p>83657</p>  <p>x4</p>	<p>3912</p>  <p>Ø3,0x13mm x28</p>	<p>3919</p>  <p>Ø3,5x20mm x5</p>

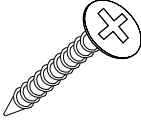
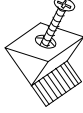
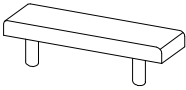
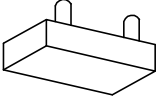
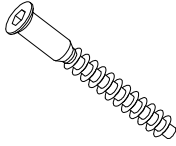

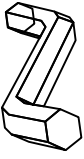
1

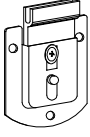
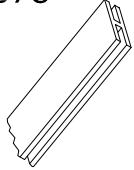
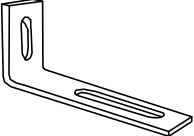
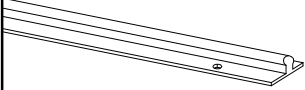
4057

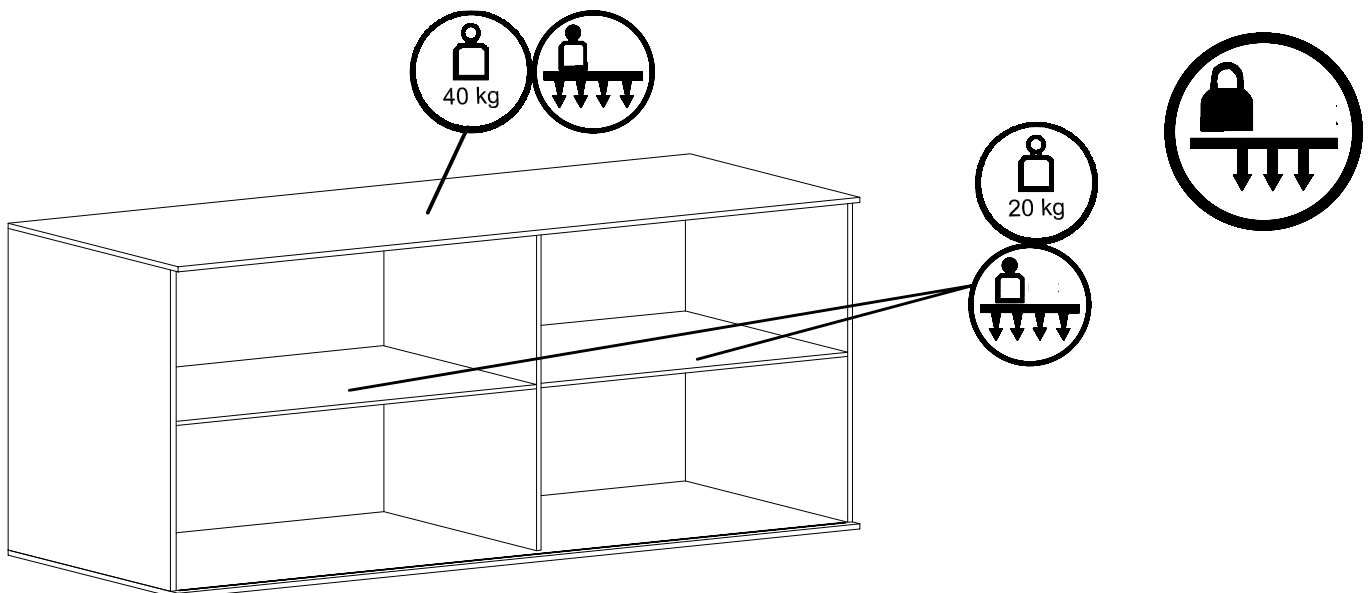

x10

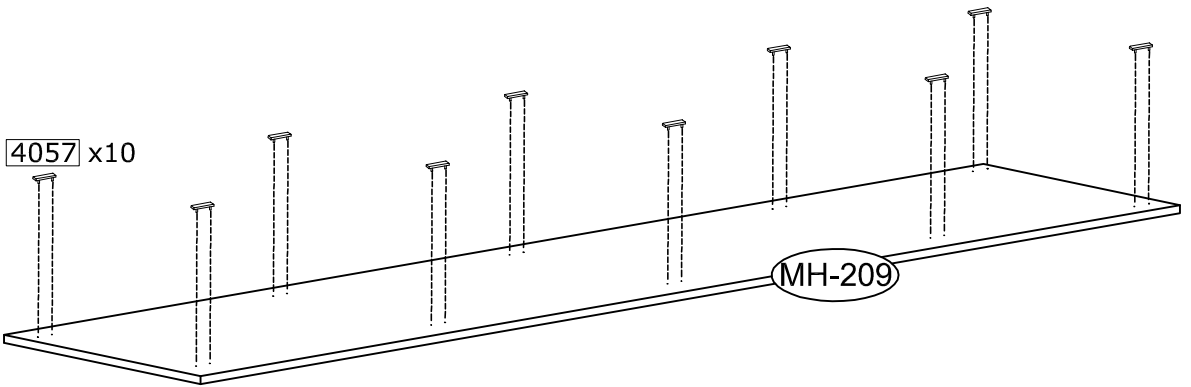
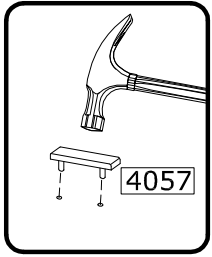

2

4066



x6

83657



x2

3912



3,0X13 x14

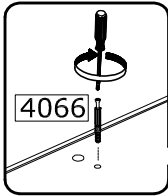

4066

4066 x6

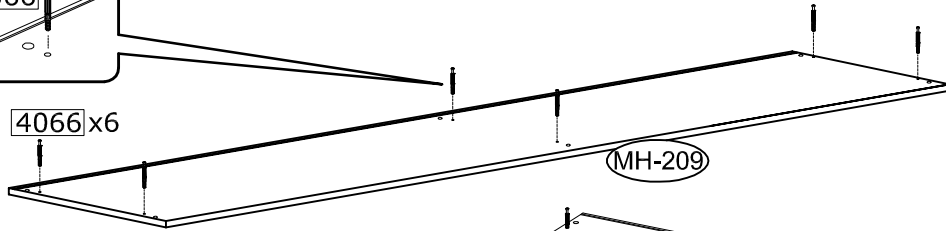

83657

3912 x14

MH-202

3

4017



x4

3989



x8

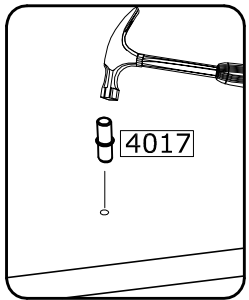

4017

x2

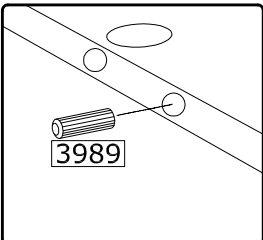

3989

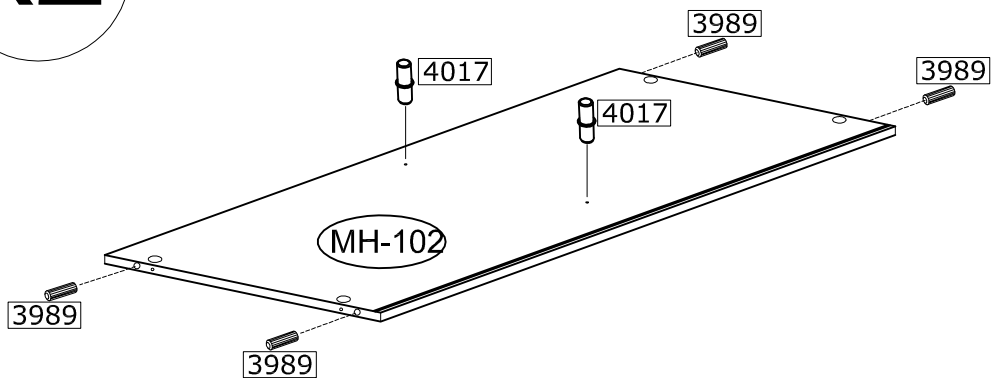

3989

4017

4017

3989

MH-102

3989

3989

4

4066
x6

83657
x2

3912
x14

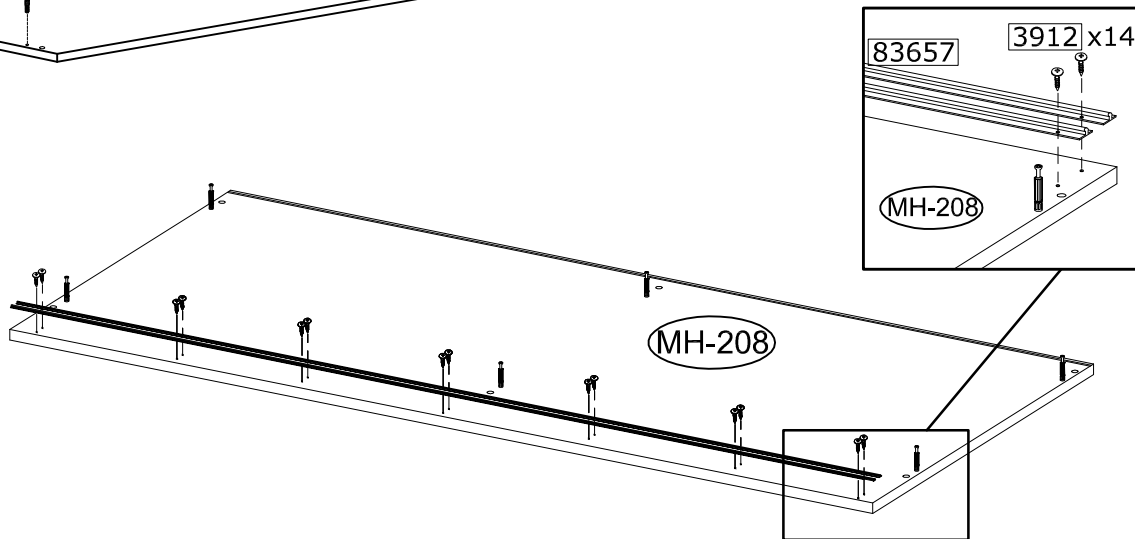
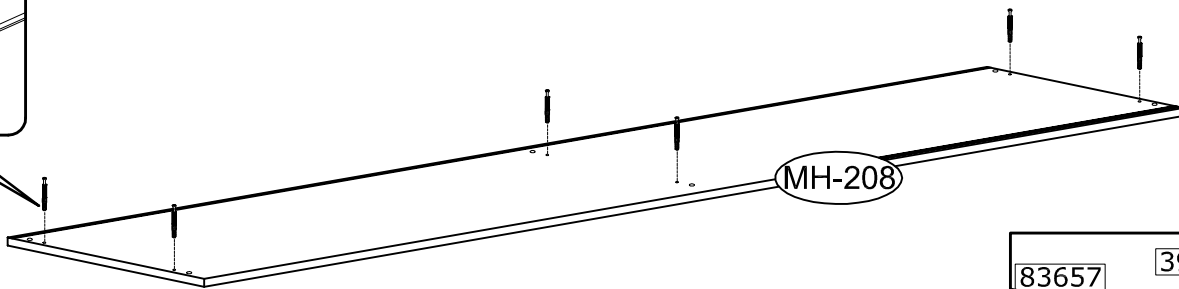
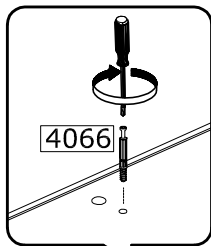

5

4017
x4

3989
x4

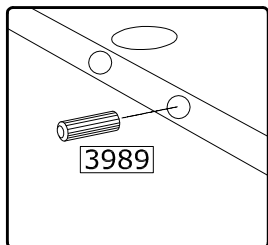
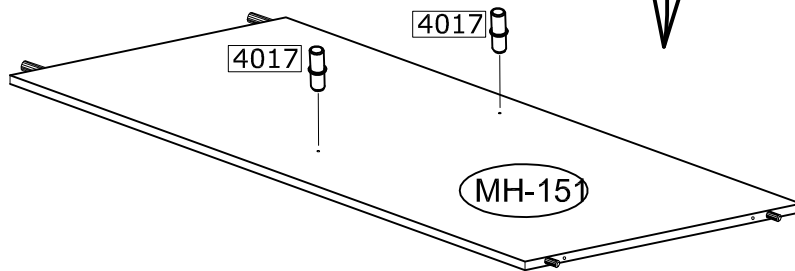
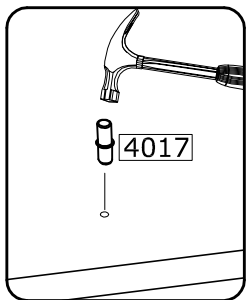
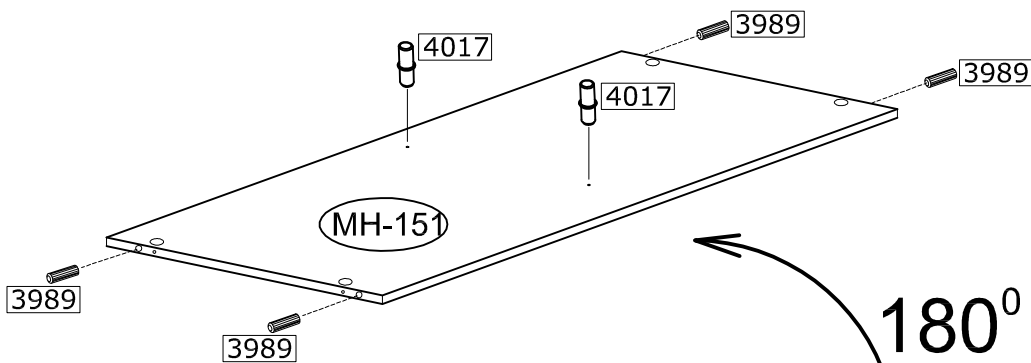

6

3996

x6

136236

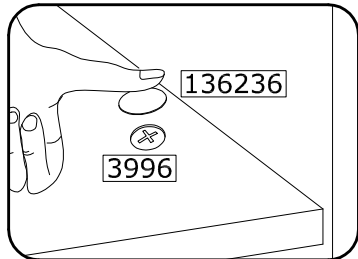
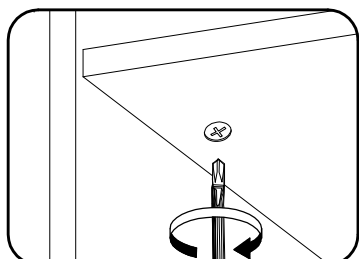
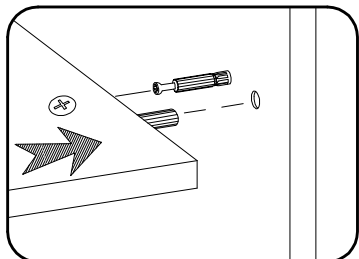
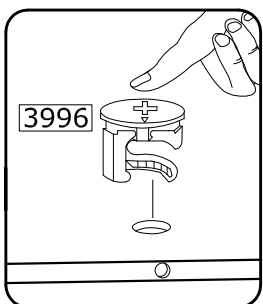
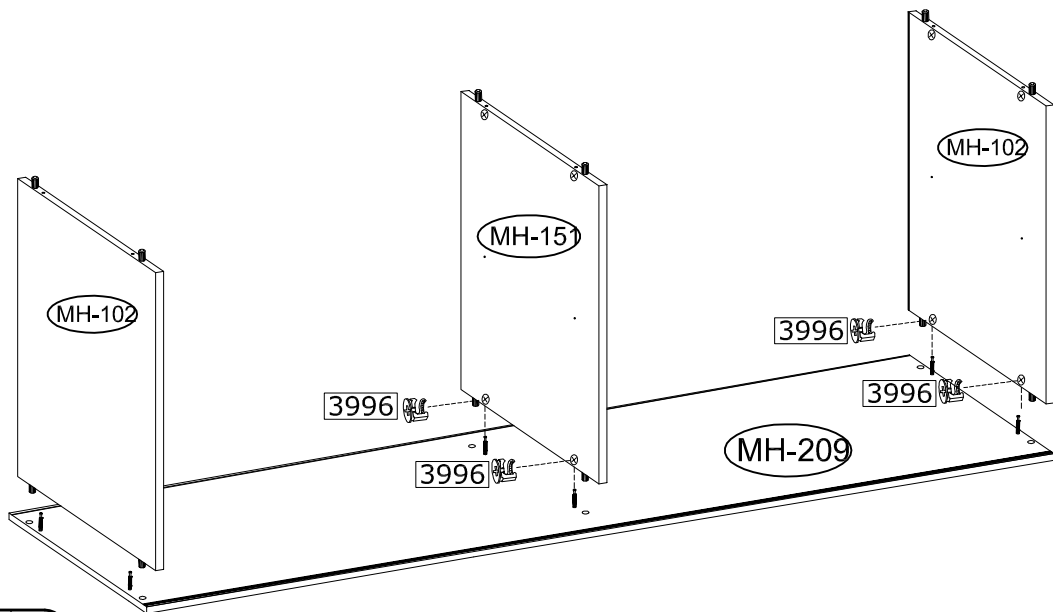
x6

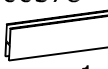

7

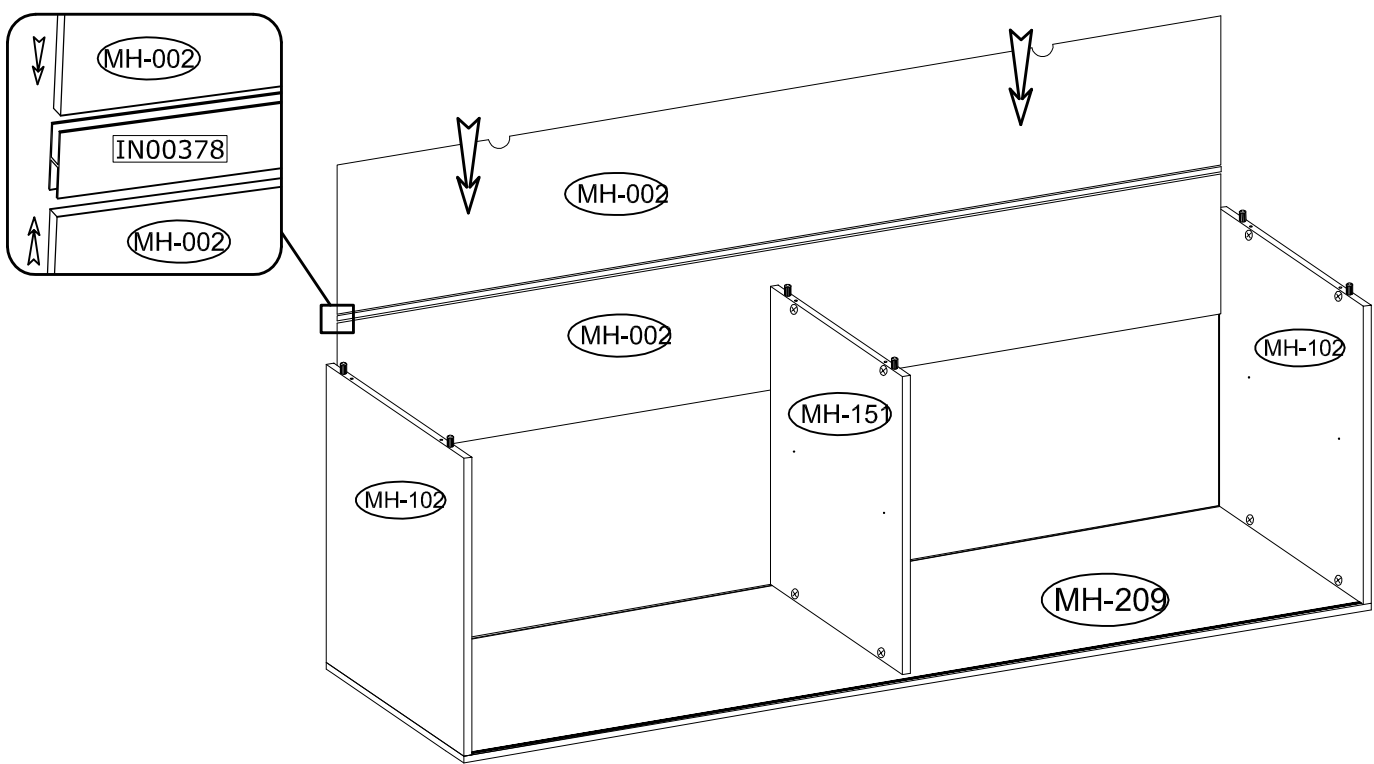
IN00378

x1



8

3996



x6

136236



x6

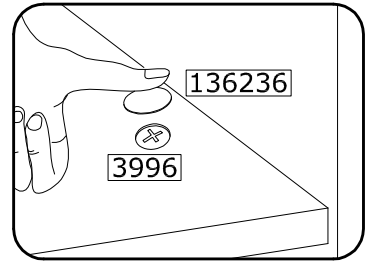
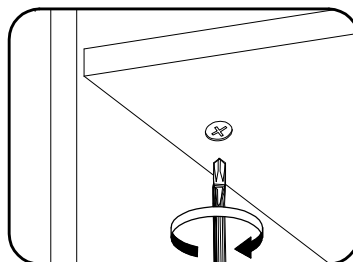
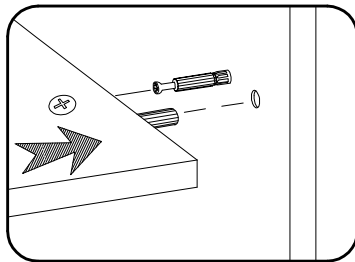
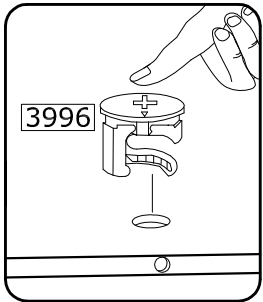
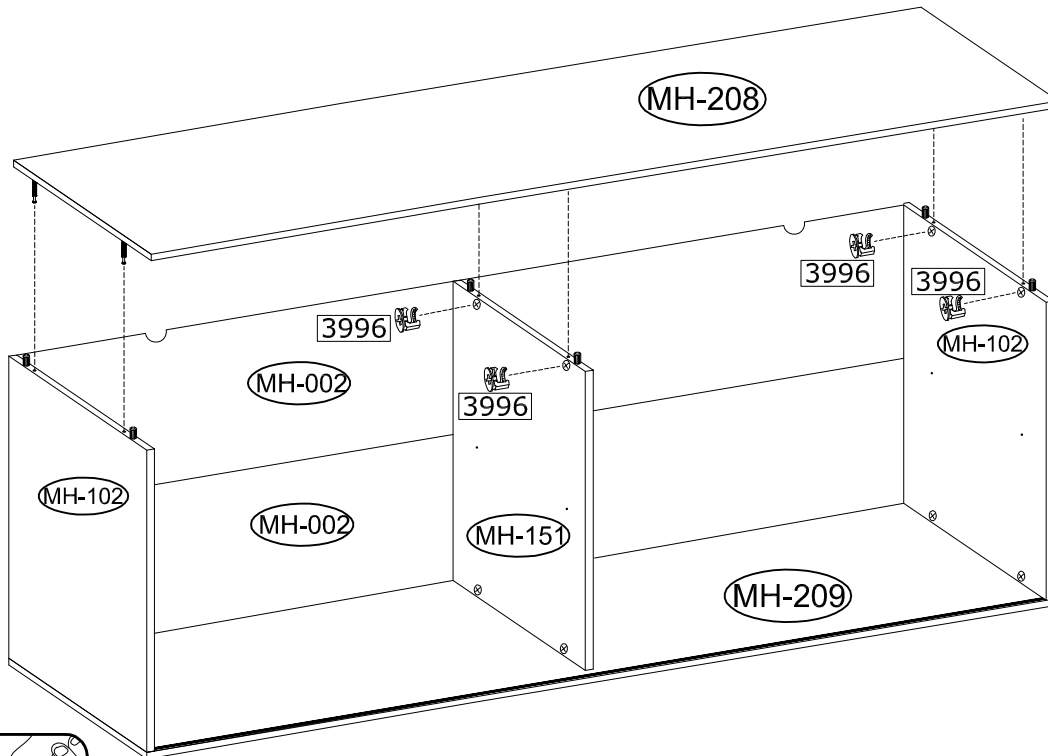

9

4044



x20

3919



x5

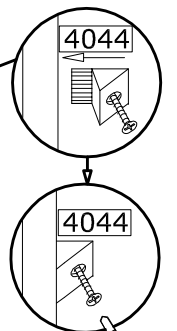
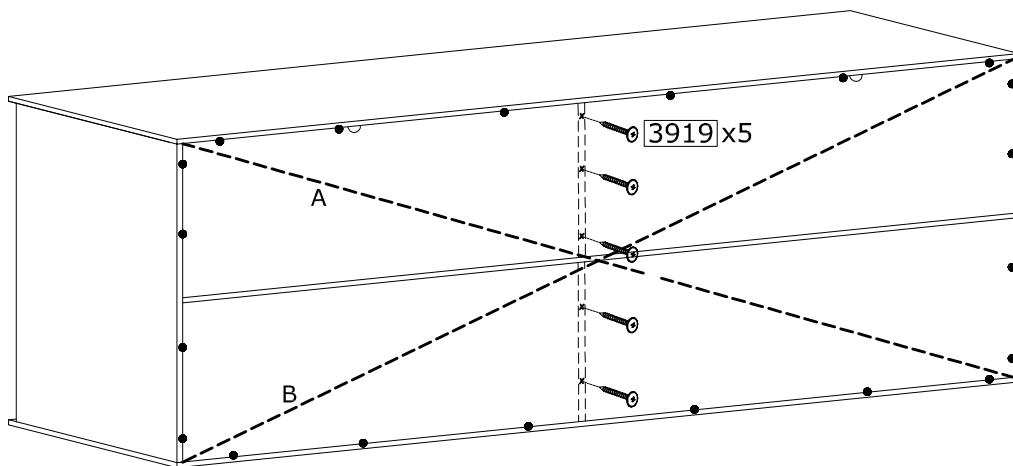
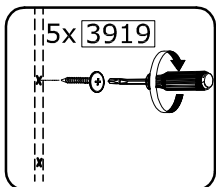



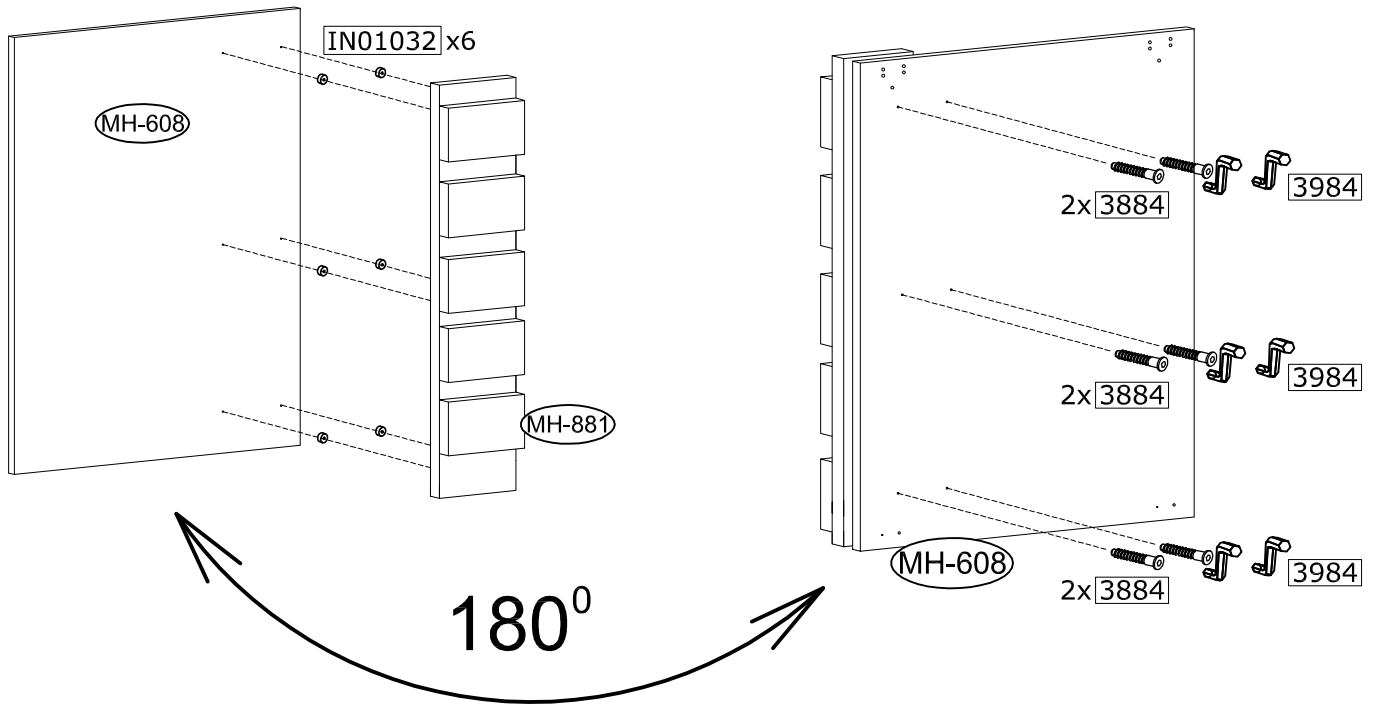

10

IN01032  x6	3884  x6	3984  x1		
---	--	--	--	--



11

IN01006  x2	IN01007  x2	3923  x8	3879  x2	
--	--	---	---	---

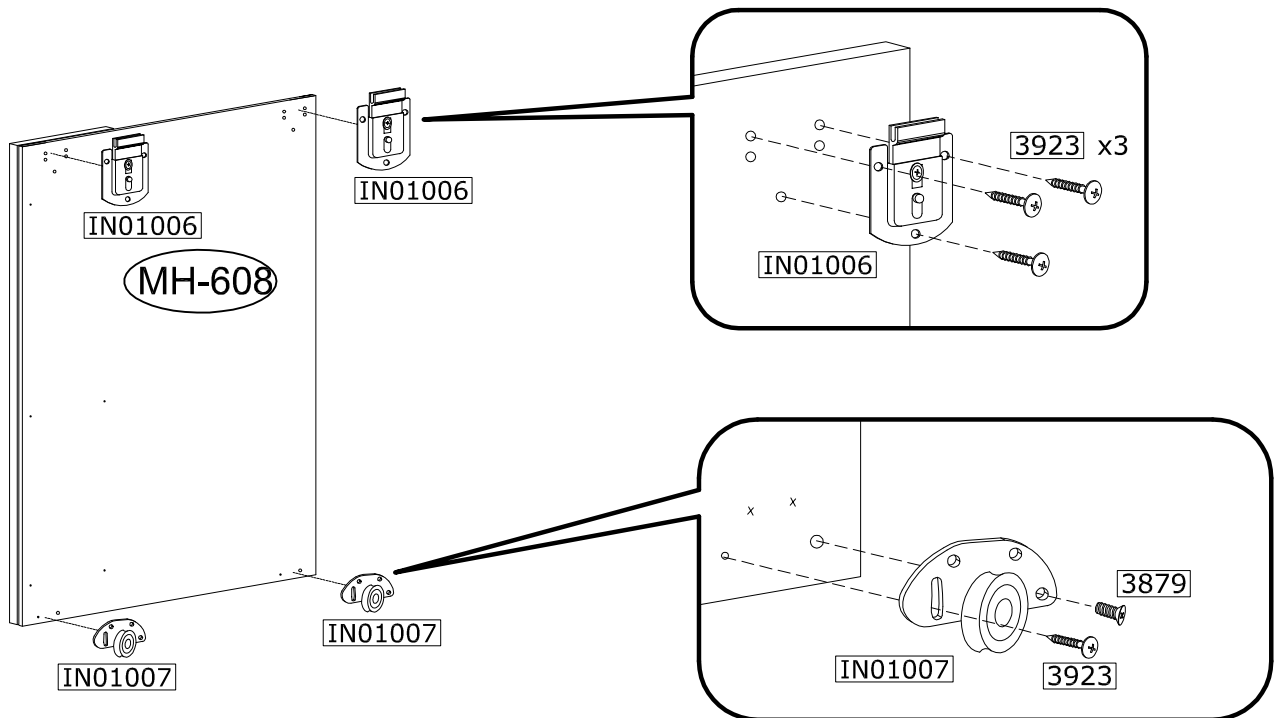

12

IN01006



x4

IN01007



x4

3923



x16

3879



x4

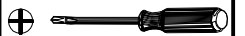

x2

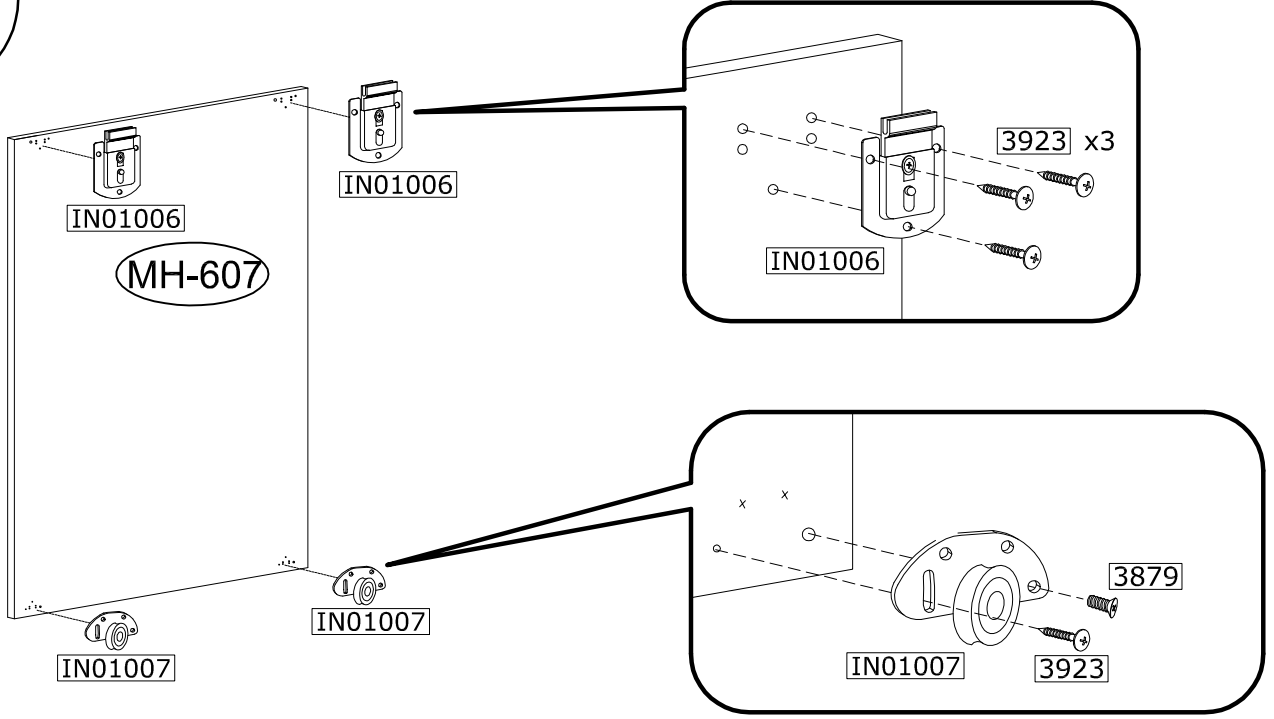

13

IN01112



x1

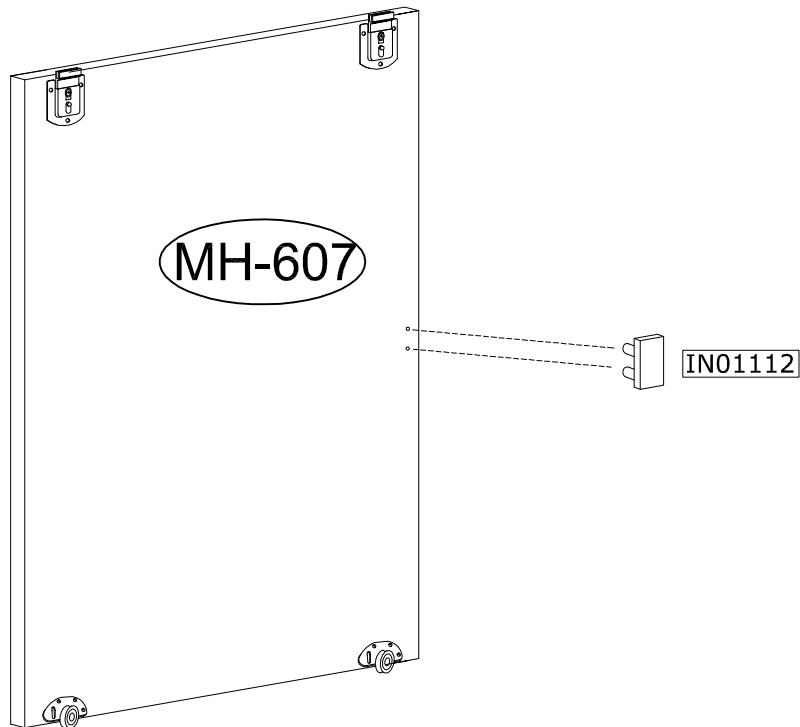

14

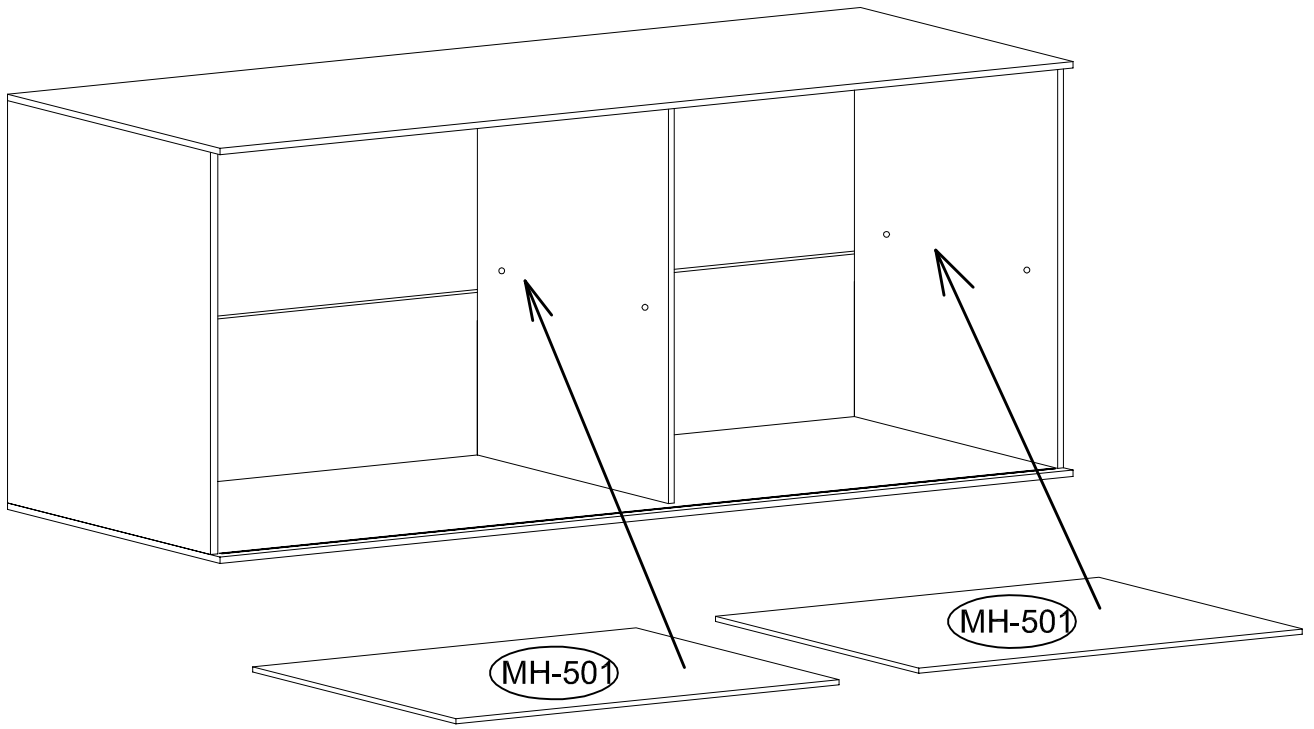

15

3923
x8

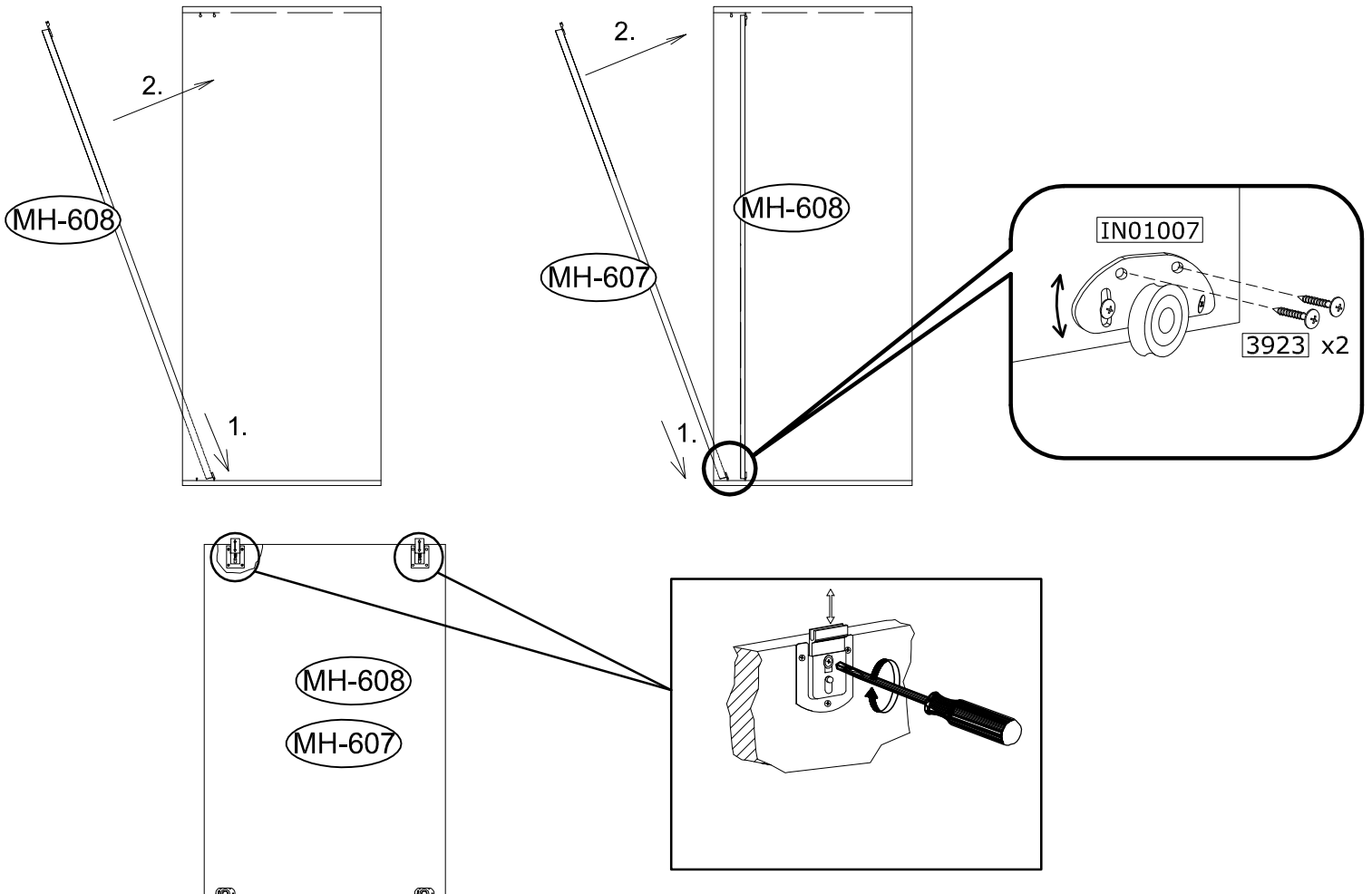

16

