

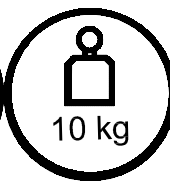

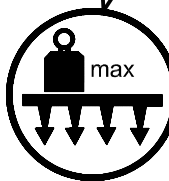

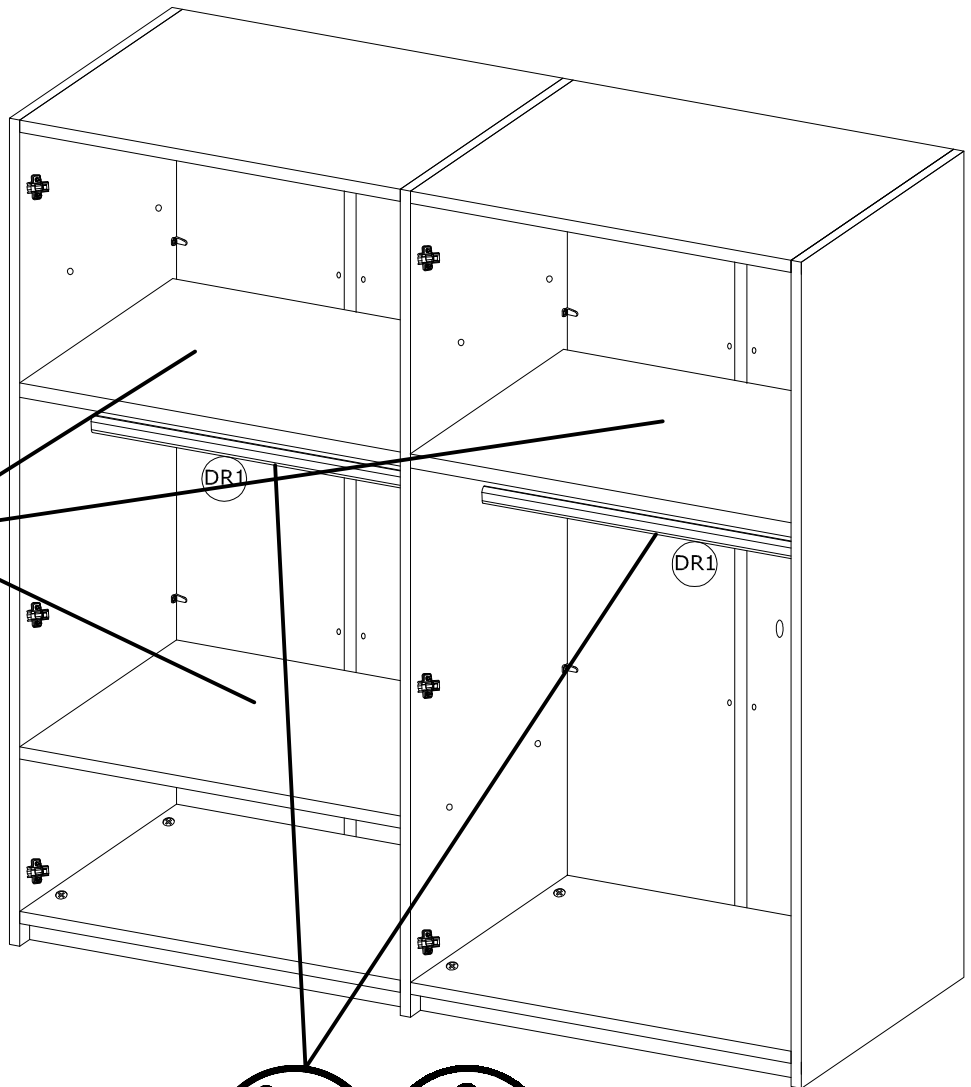

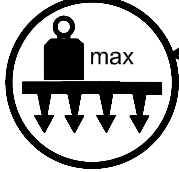
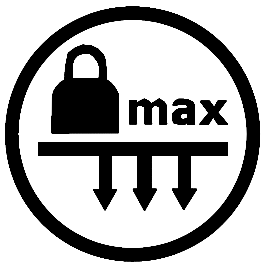
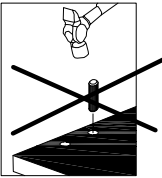
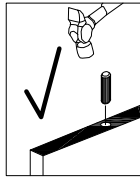
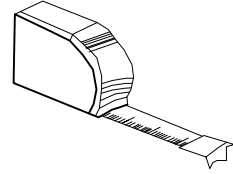
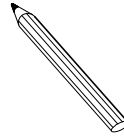
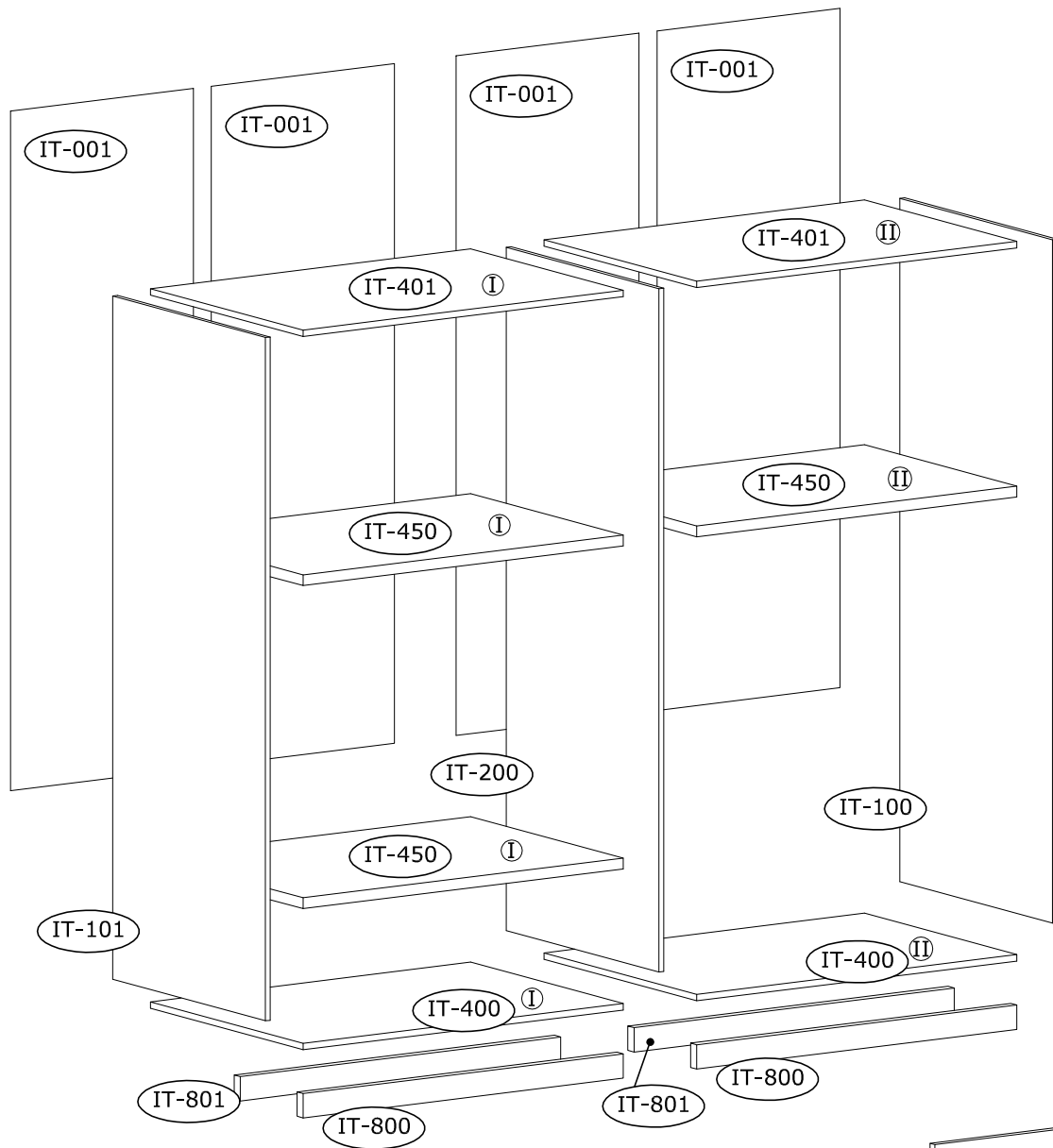
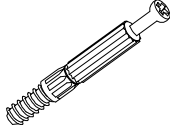

⊕ PH2

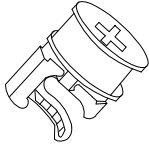
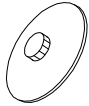
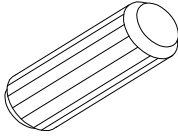
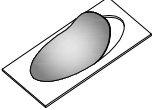
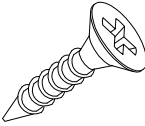

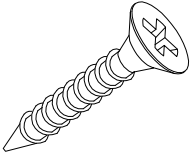
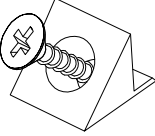
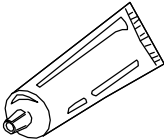
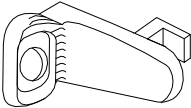
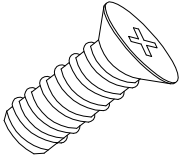
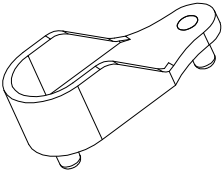

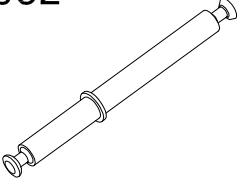
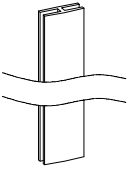
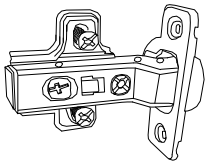
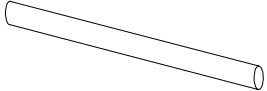
<p>4066</p>  <p>Ø6.5x36.5mm x16</p>	<p>3996</p>  <p>Ø15x16mm x16</p>	<p>3997</p>  <p>Ø15x22mm x12</p>	<p>136236</p>  <p>Ø20 x28</p>
<p>3989</p>  <p>Ø8x30mm x40</p>	<p>70281</p>  <p>Ø14 x14</p>	<p>3917</p>  <p>Ø3,5x13mm x32</p>	<p>4057</p>  <p>x10</p>
<p>3925</p>  <p>Ø4.0x25mm x14</p>	<p>4044</p>  <p>15x14x11 mm x30</p>	<p>3983</p>  <p>x2</p>	<p>4079</p>  <p>30x25x16 mm x8</p>
<p>3878</p>  <p>Ø6.3x11mm x8</p>	<p>4069</p>  <p>x4</p>	<p>3912</p>  <p>Ø3,0x13mm x4</p>	<p>4062</p>  <p>Ø6,5x76 mm x6</p>
<p>IN00378</p>  <p>L-2276mm x2</p>	<p>62779</p>  <p>x16</p>	<p>3668</p>  <p>L-872 x2</p>	<p>3918</p>  <p>Ø3,5x16mm x4</p>
<p>71900</p>  <p>75x15x32 mm x2</p>			

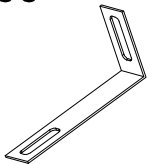
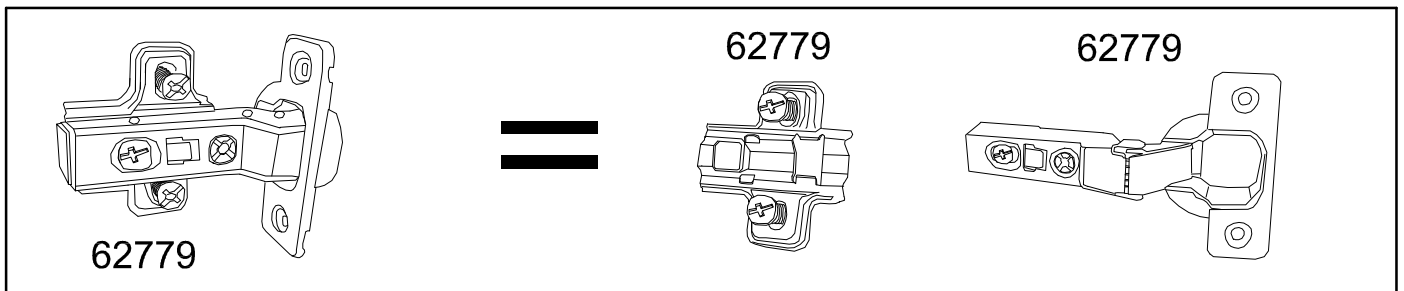

1

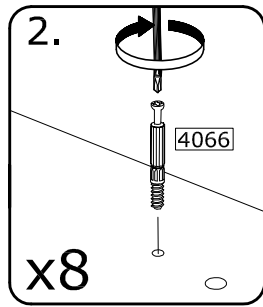
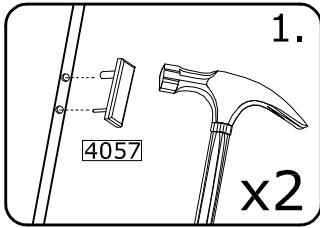
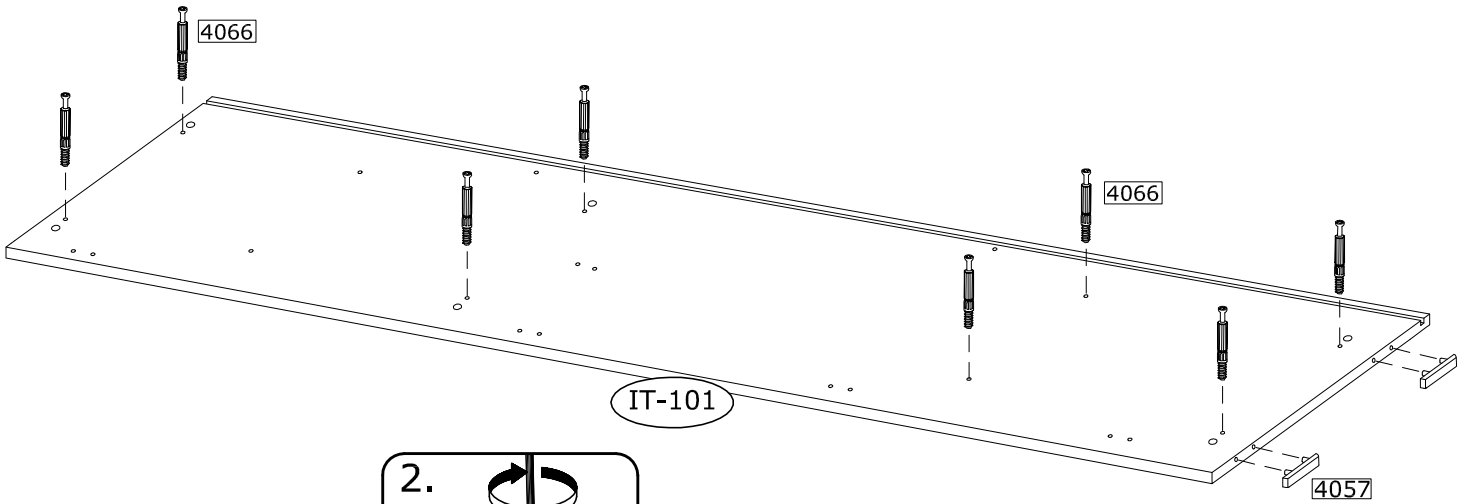
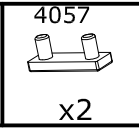
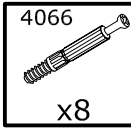

2

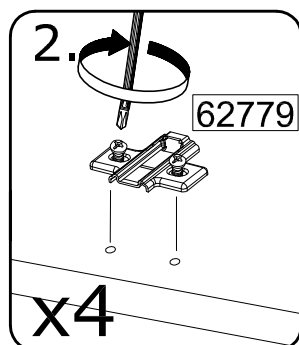
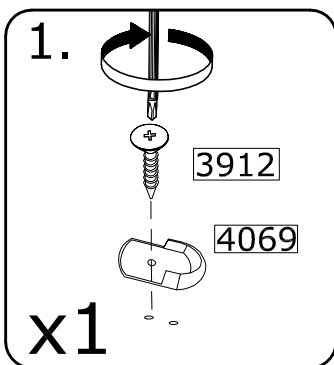
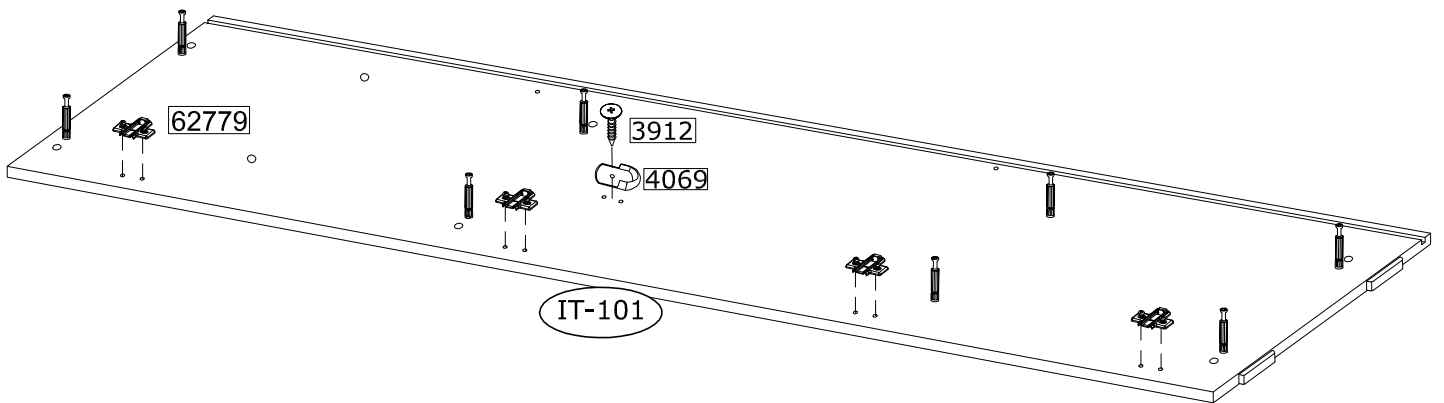
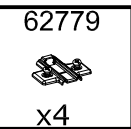
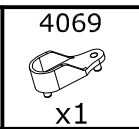
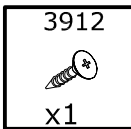

3

4066  x6	4057  x2		 PH2
--	--	--	---

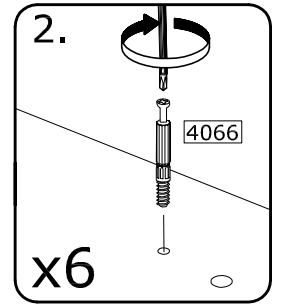
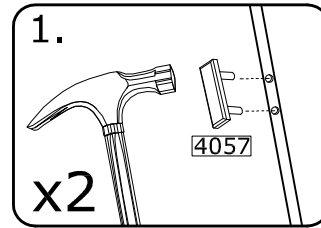
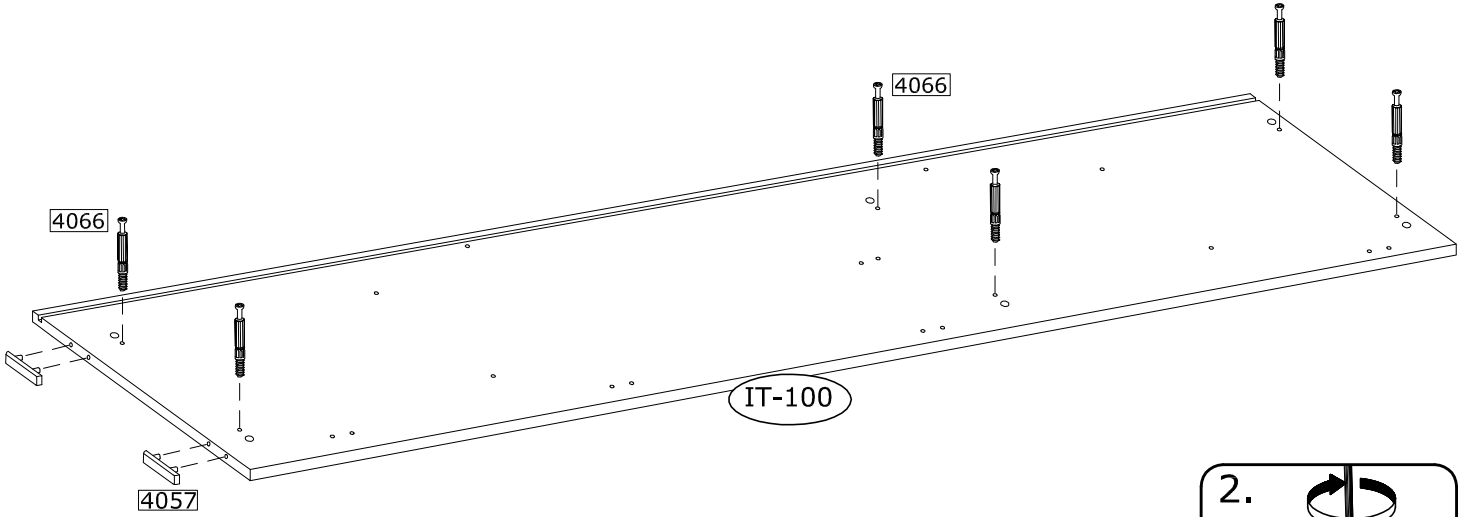



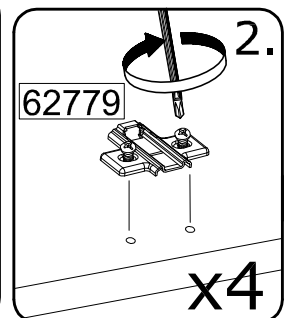
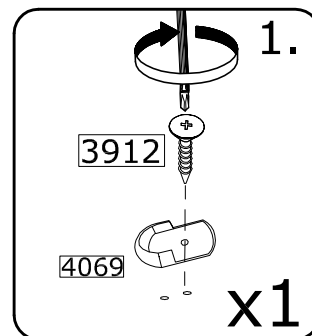
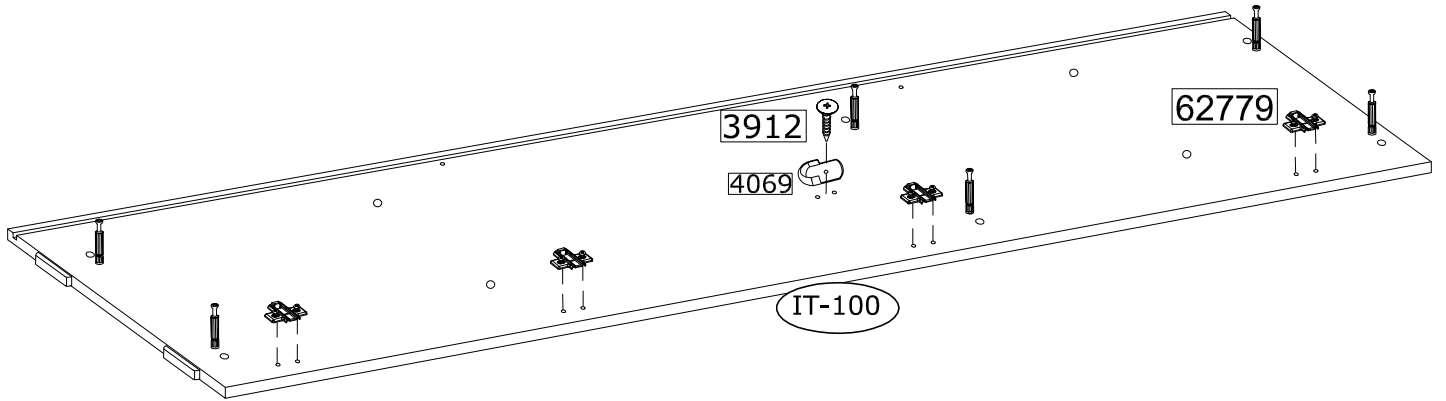

4

3912  x1	4069  x1	62779  x4	 PH2 PH1
---	---	--	--



5

62779  x4	3912  x1	4069  x1		 ⊕ PH1  ⊕ PH2
---	--	--	--	---

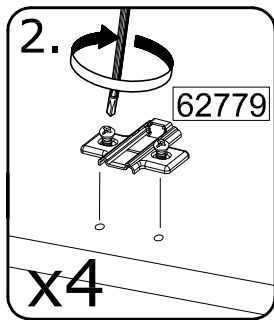
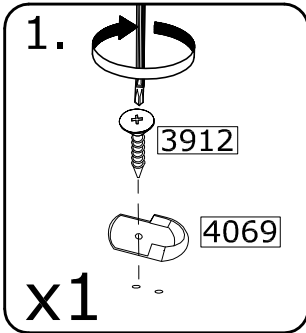
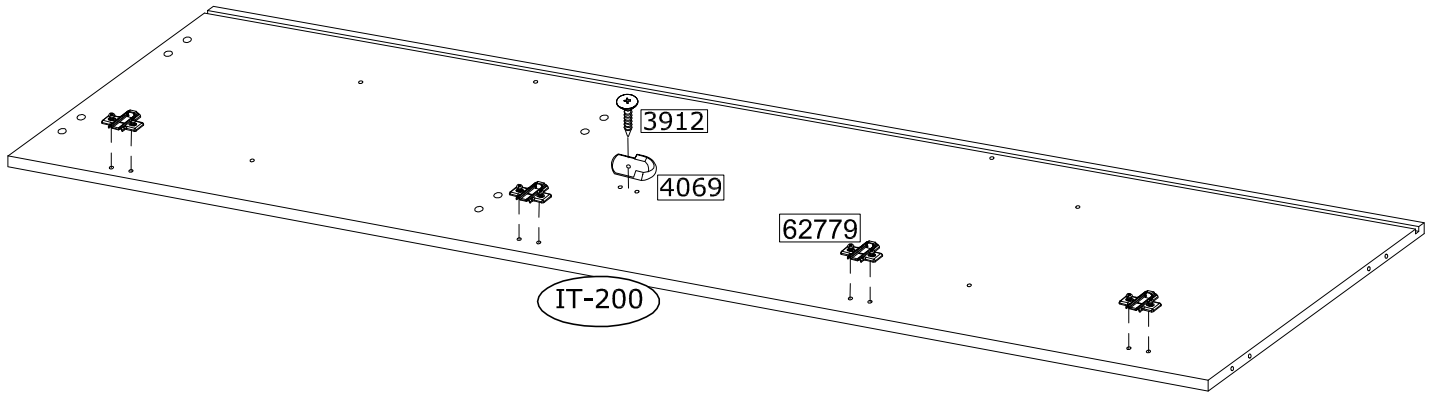

6

4057  x2	3912  x1	4069  x1		 ⊕ PH1 
---	---	---	--	---

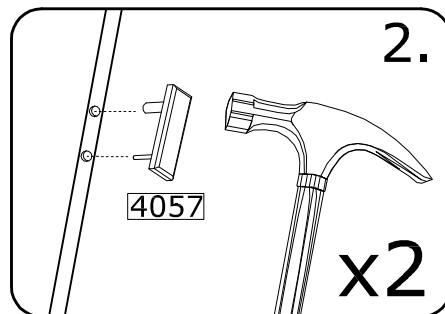
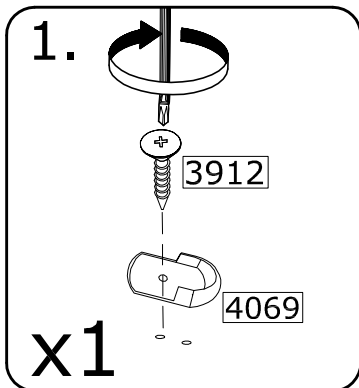
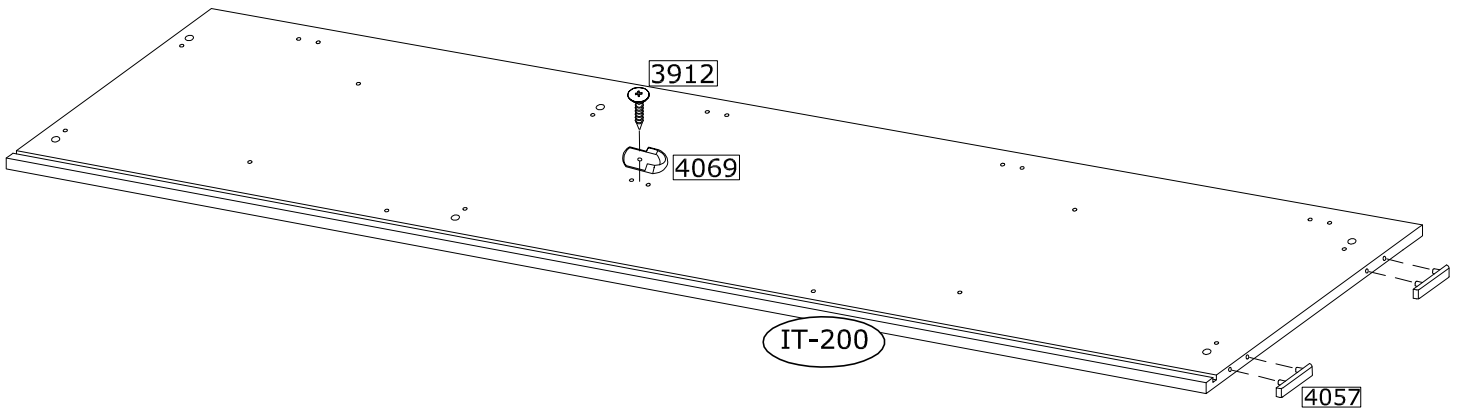

7

4066



x2

62779



x4



PH2

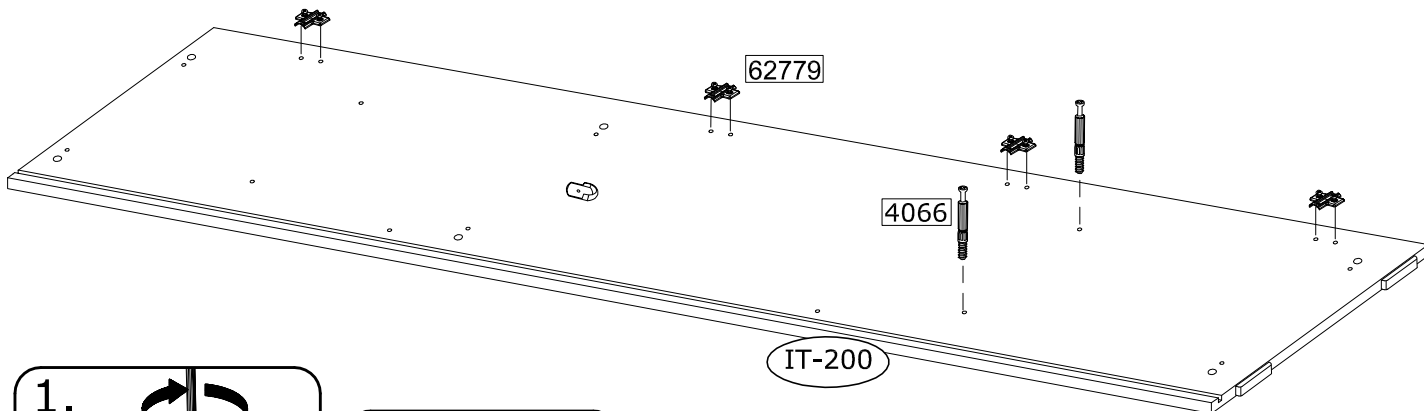

IT-200

1.



4066

x2

2.



62779

x4

8

4057



x2

3989



x8

3983



x1



x2

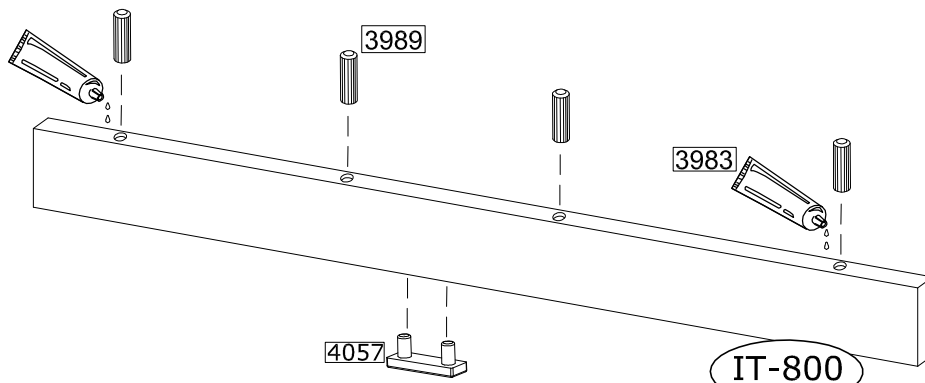

IT-800

1.

4057

x2

2.

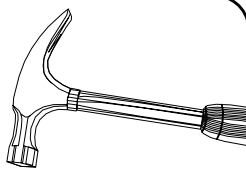

3989

3983

1.0h

x8

9

4057  x2	3989  x8	3983  x1		
--	--	--	--	--

x2

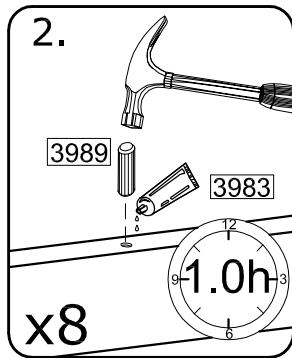
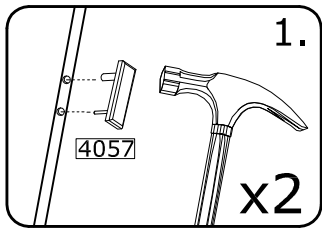
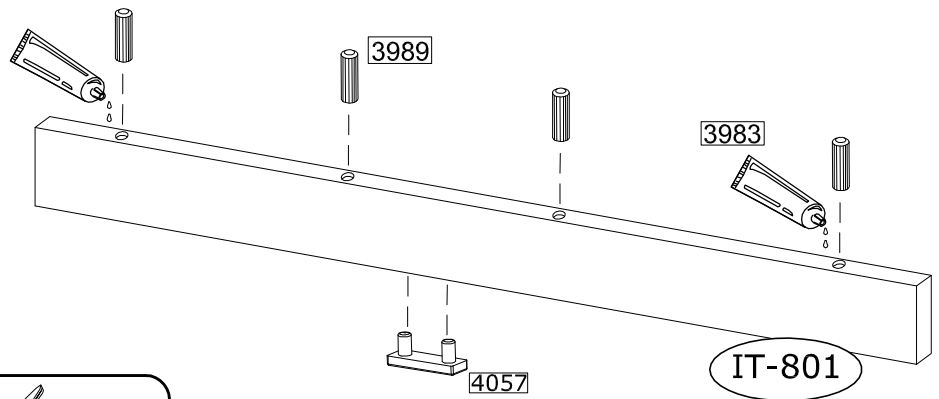

10

3983  x1		
---	--	--

x2

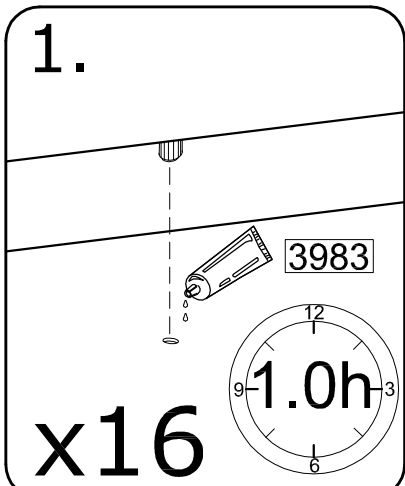
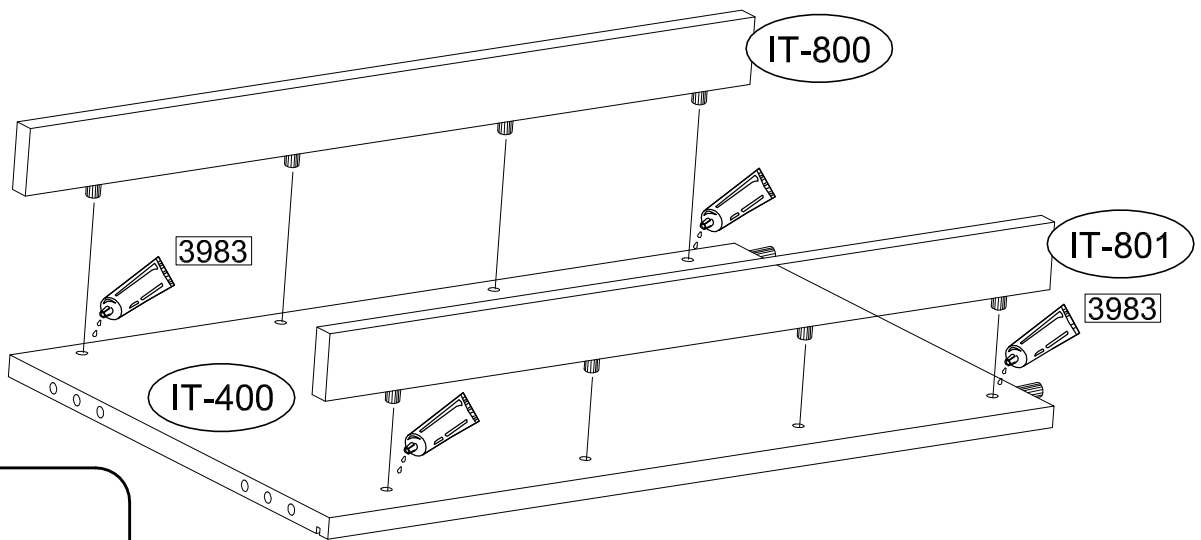

11

3989



x4

3996



x4

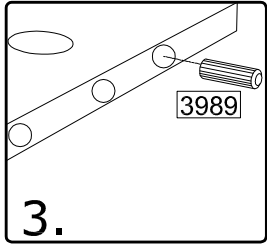

3.

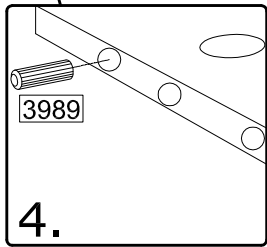

4.

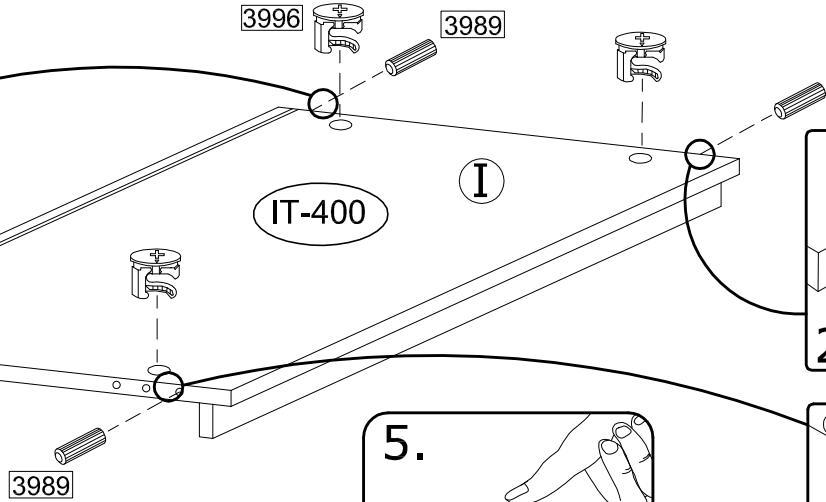

IT-400

I

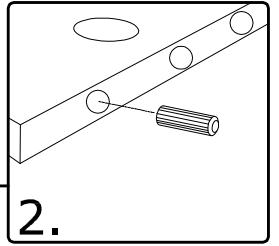

2.

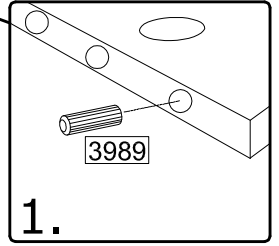

1.

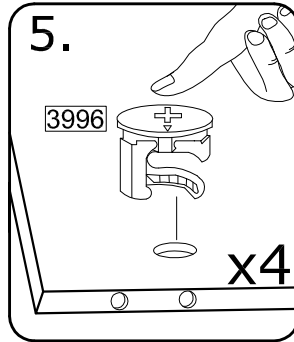

5.

3996

x4

12

3989



x4

3996



x4

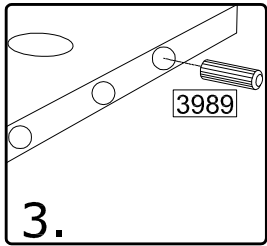

3.

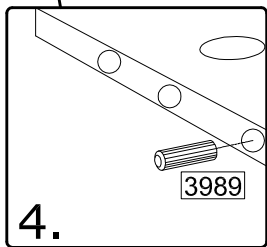

4.

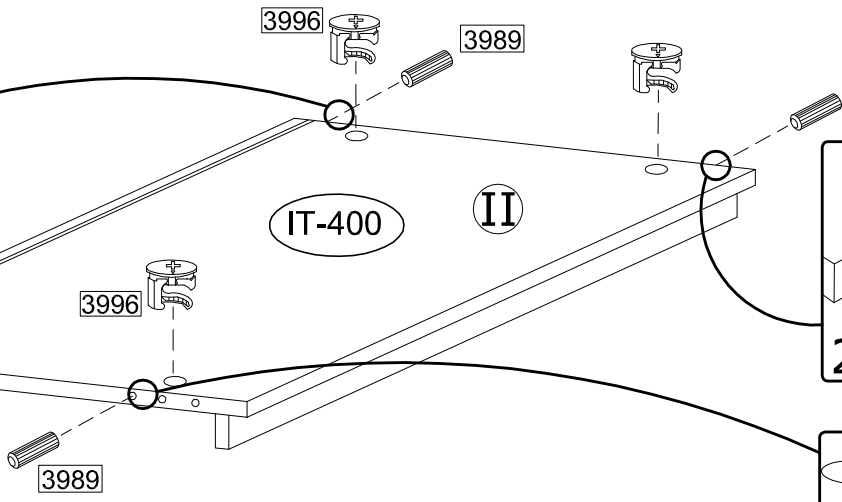

IT-400

II

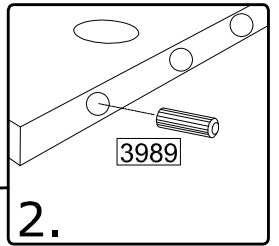

2.

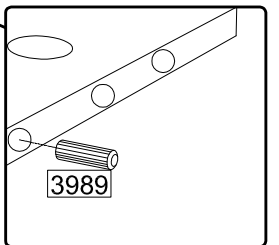

1.

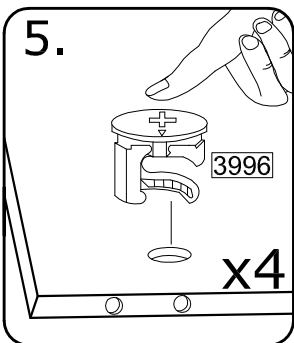

5.

3996

x4

13

3989
x4

3996
x4

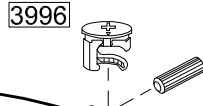
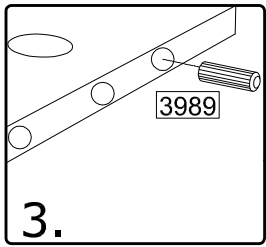
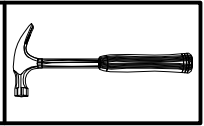

IT-401

I

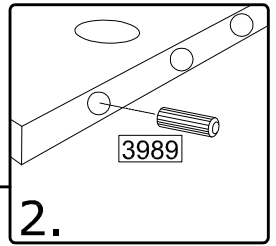

2.

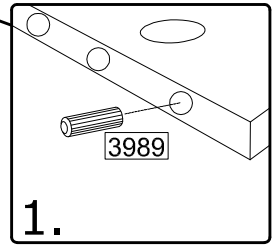
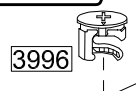

1.

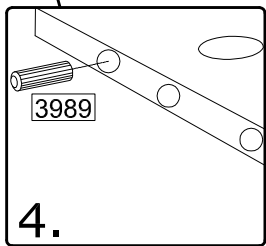

4.

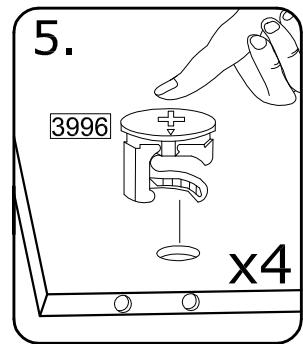

5.

3996

x4

14

3989
x4

3996
x4

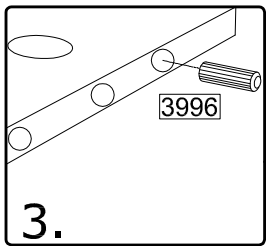
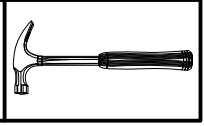

3.

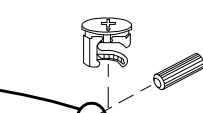

IT-401

II

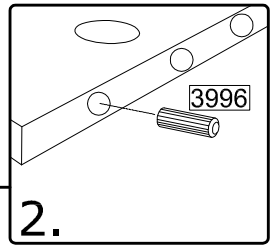

2.

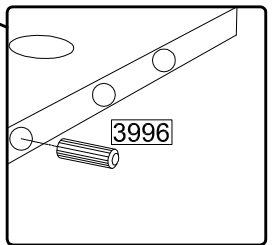
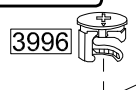

1.

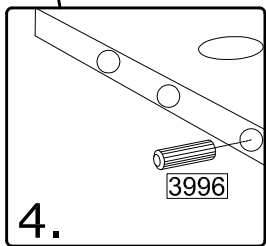

4.

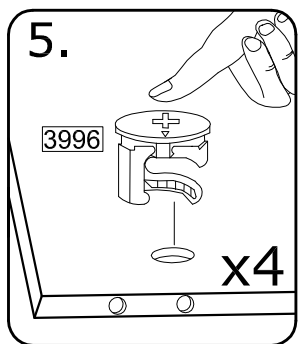

5.

3996

x4

15

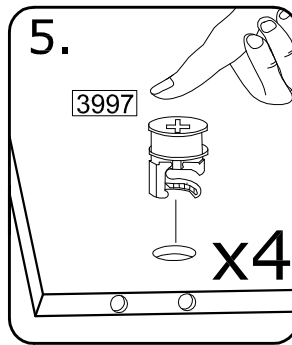
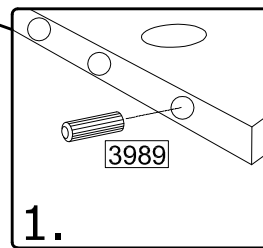
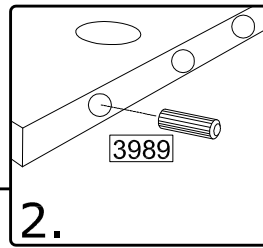
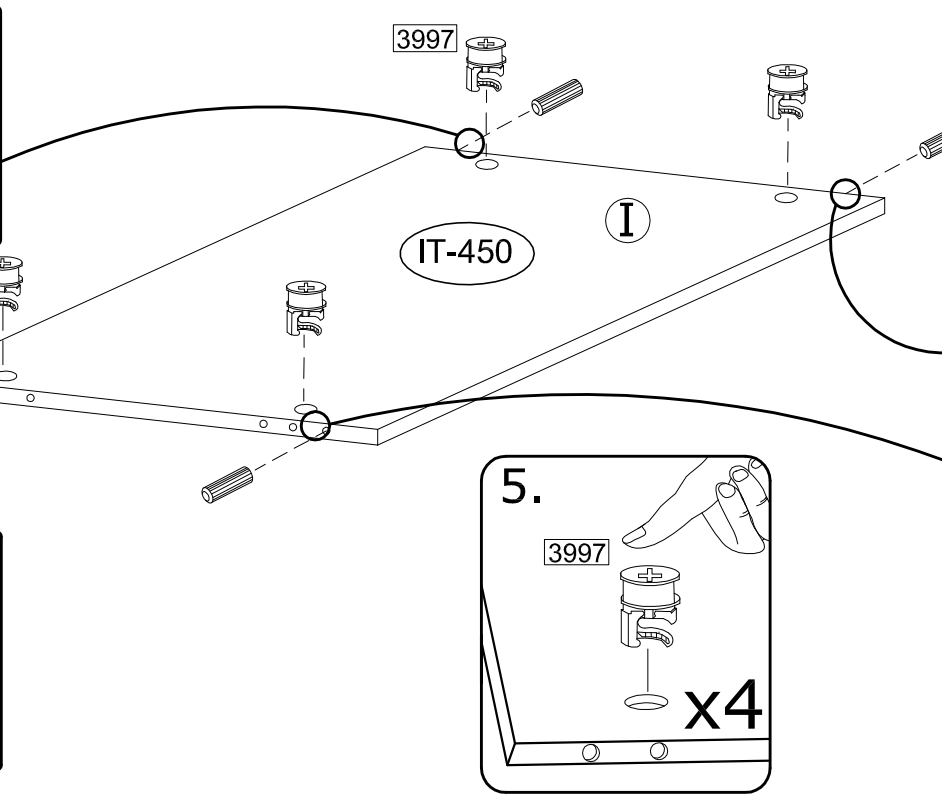
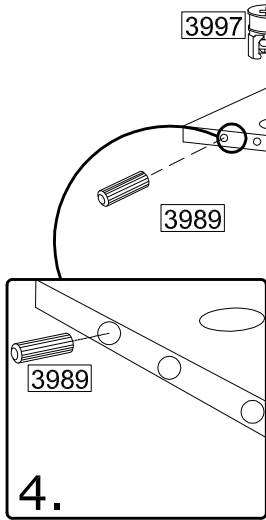
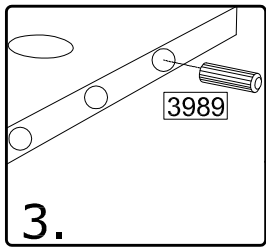
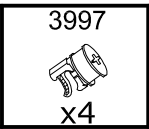
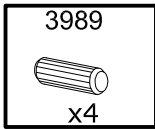

16

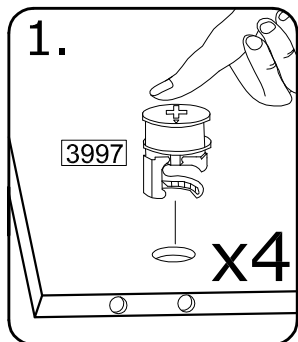
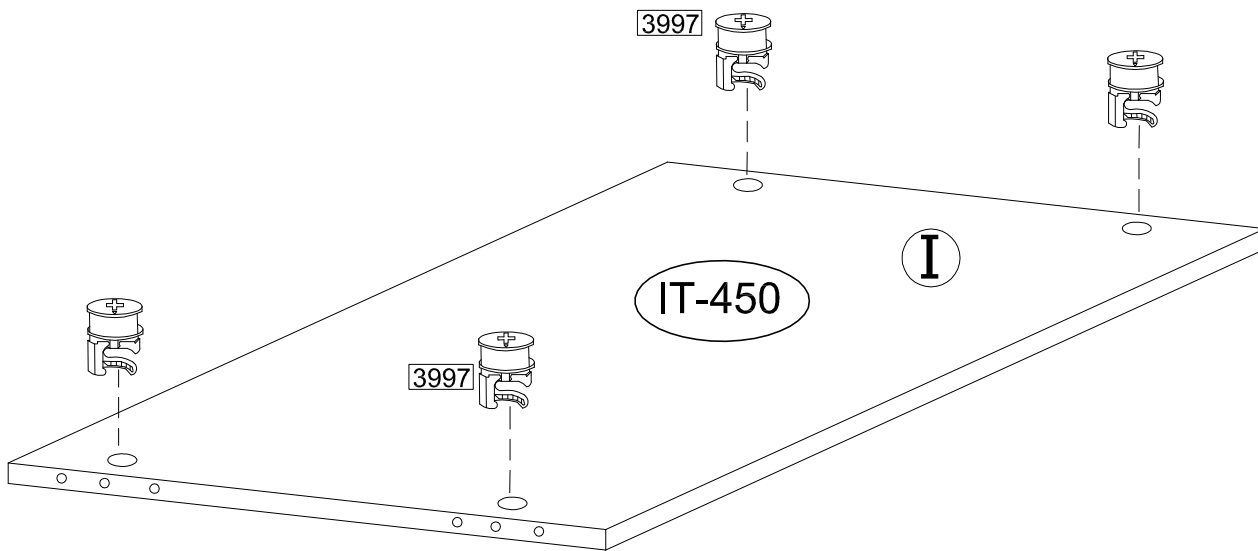
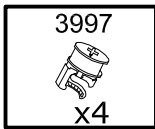

17

3989
x4

3997
x4

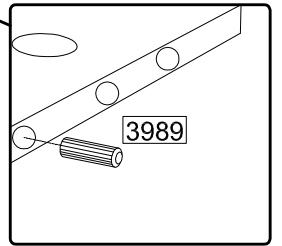
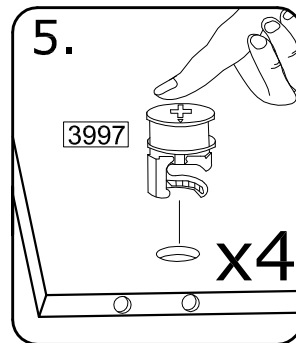
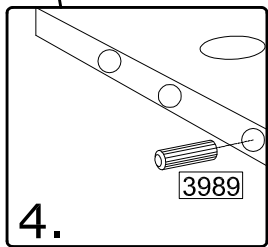
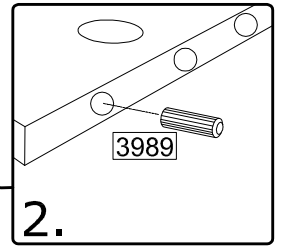
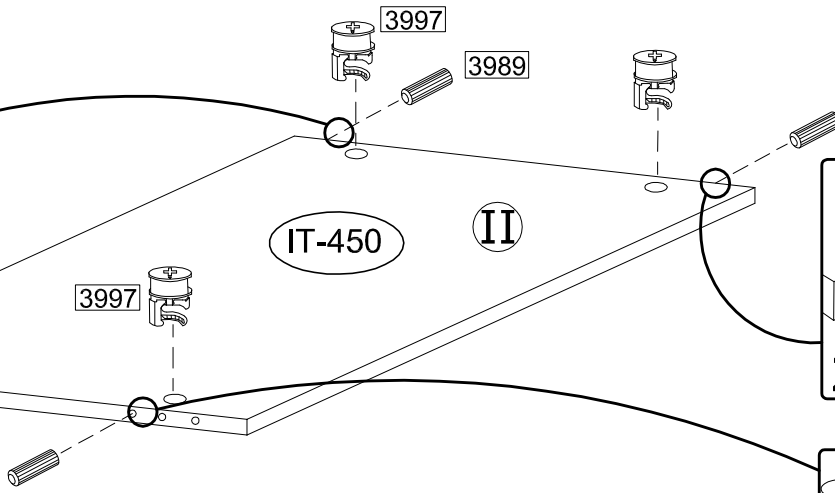
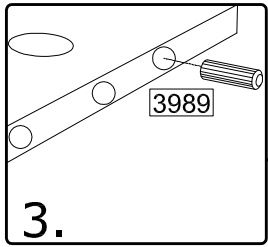

18

 62779 x8	 3917 x16	 PH2
---	---	---

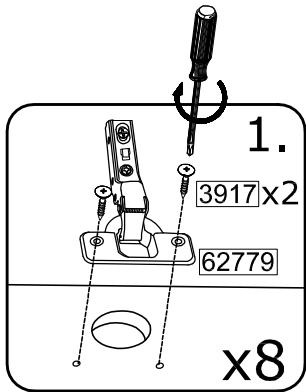
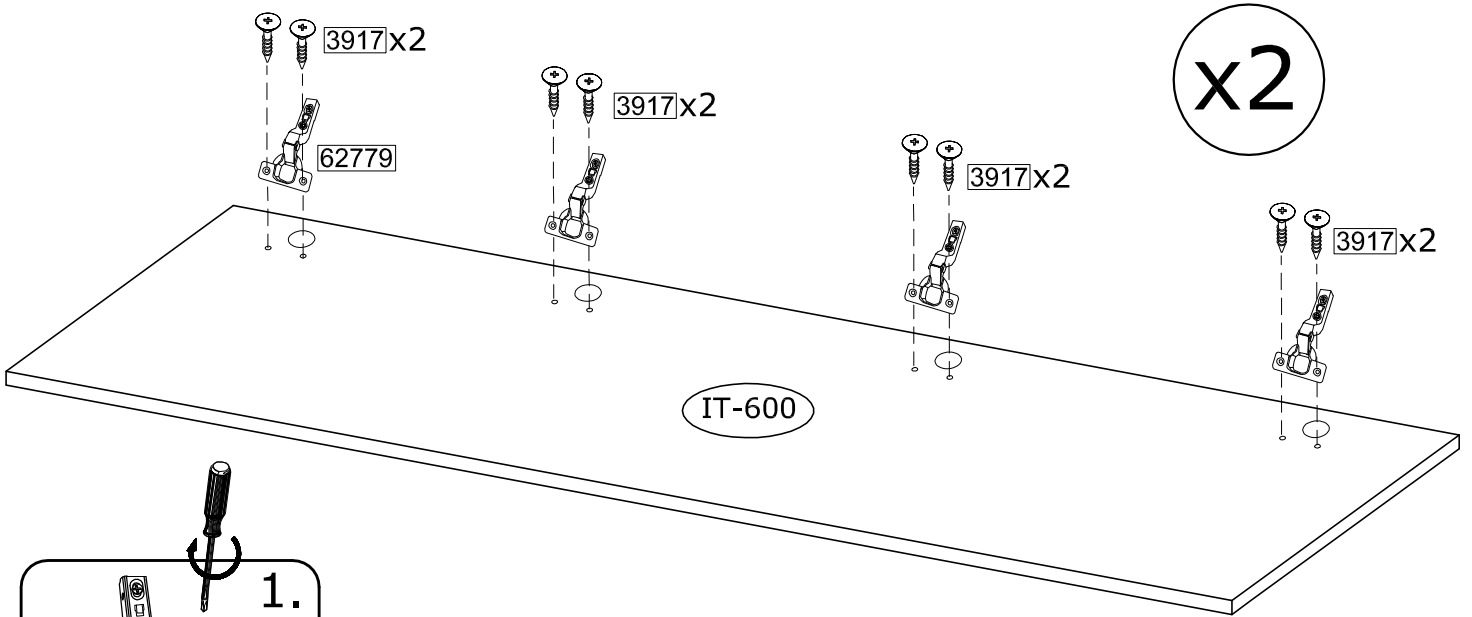

19

 62779 x8	 3917 x16	 3925 x14	 70281 x14	 PH2
--	--	--	---	--

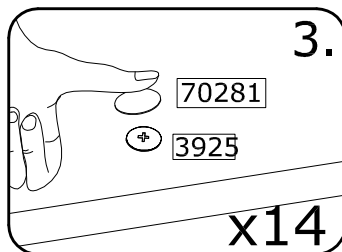
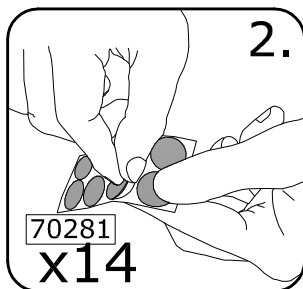
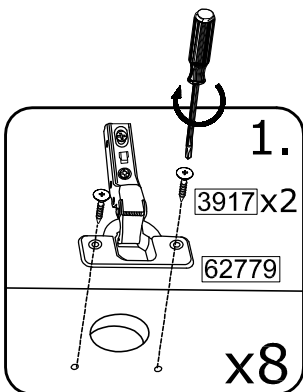
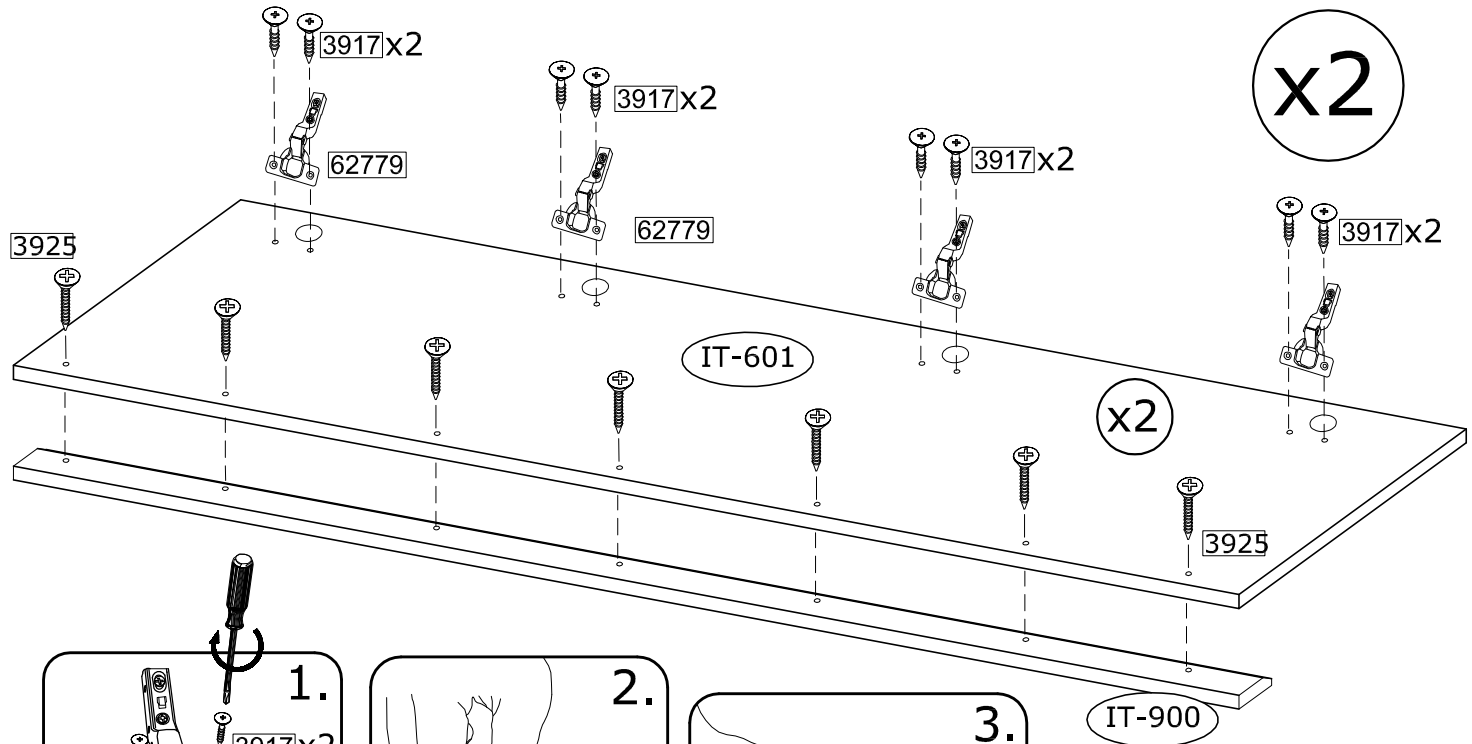

20

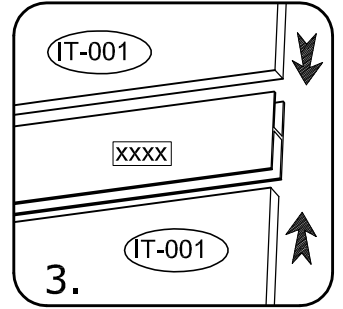
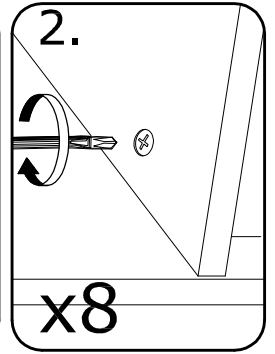
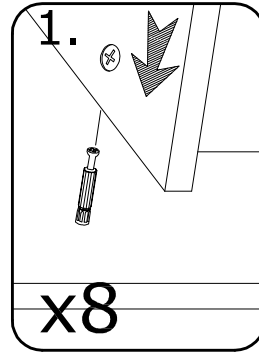
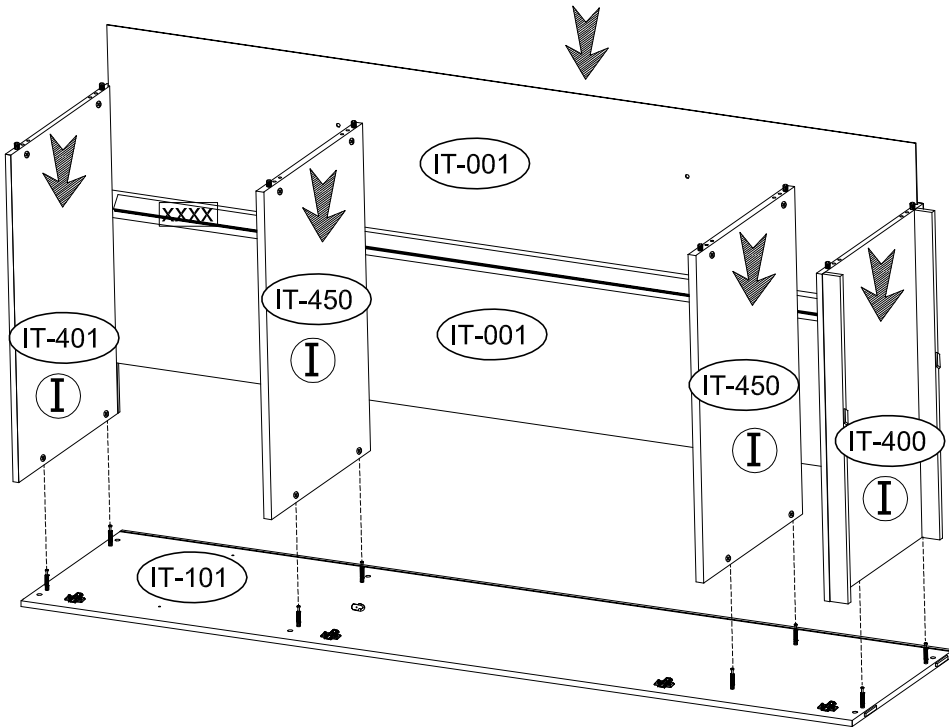
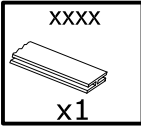

21

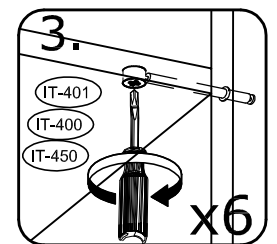
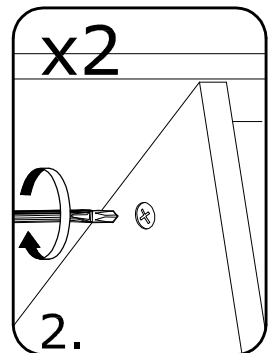
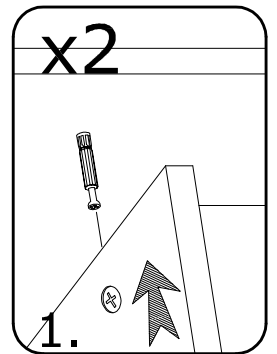
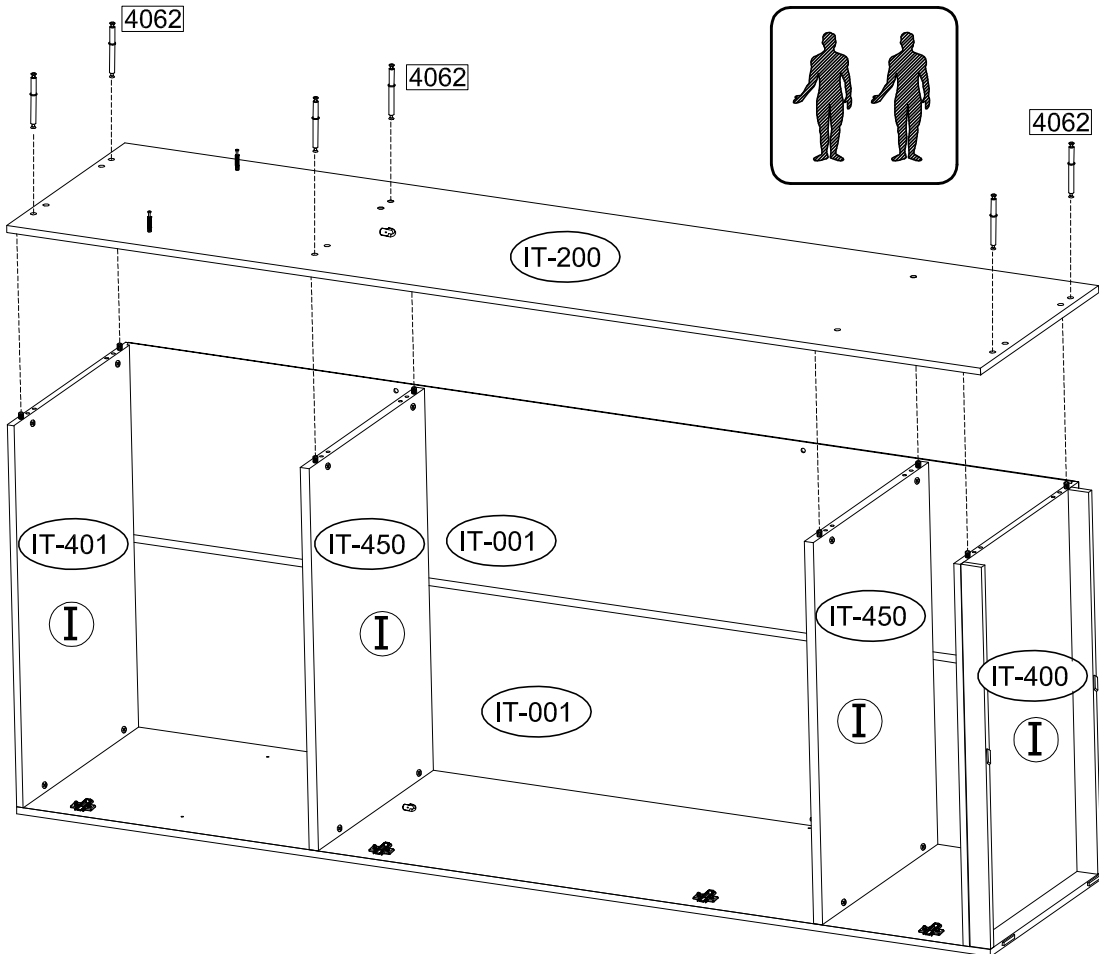
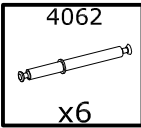

22

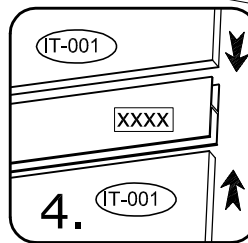
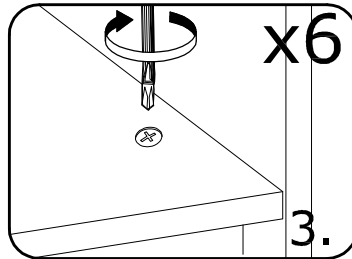
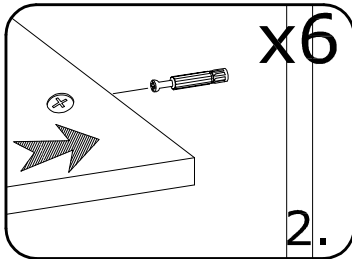
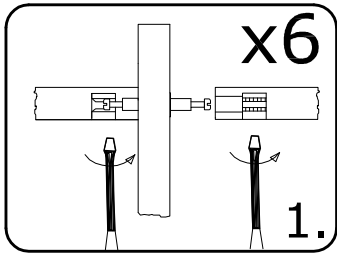
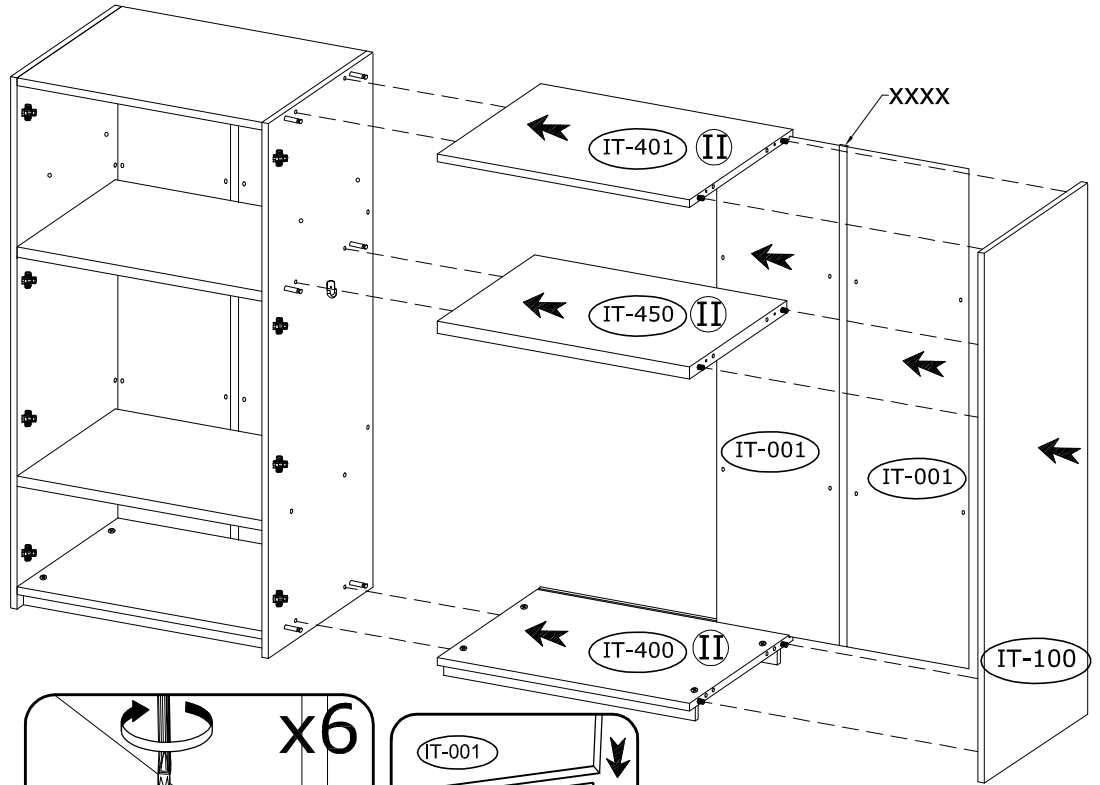
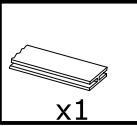

23

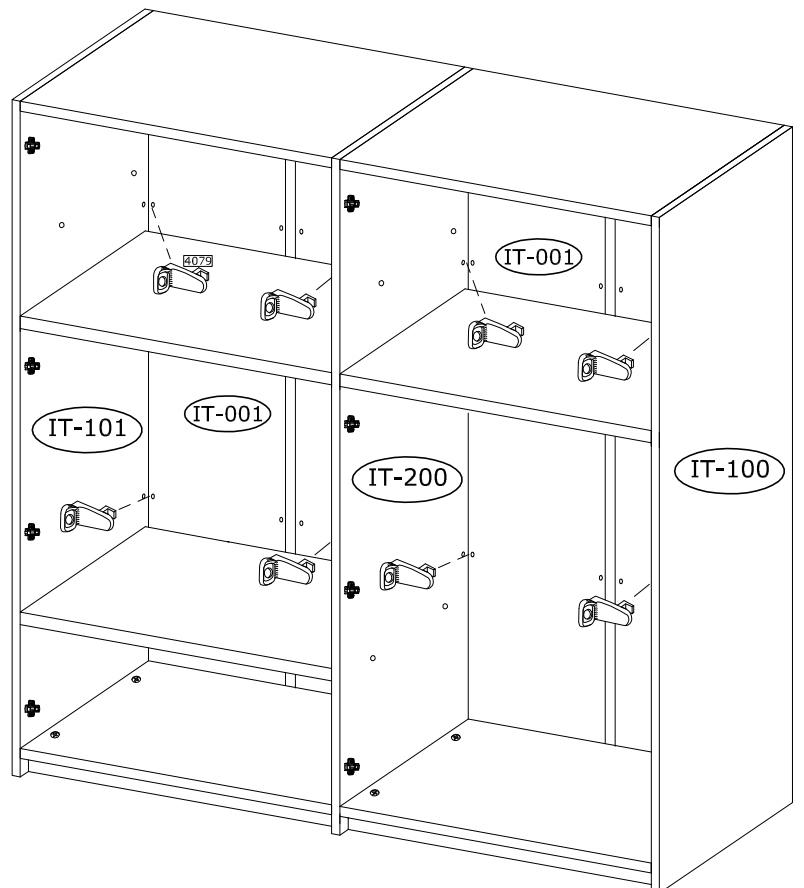
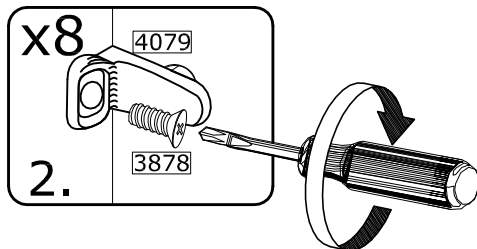
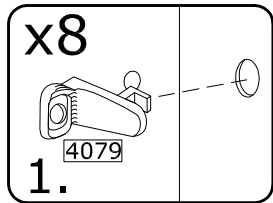
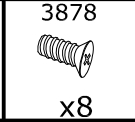
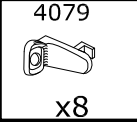

24

4044
x30

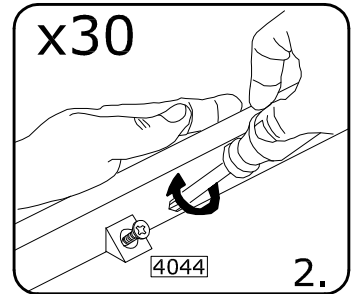
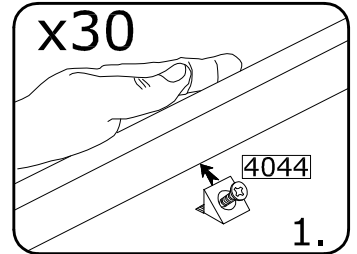
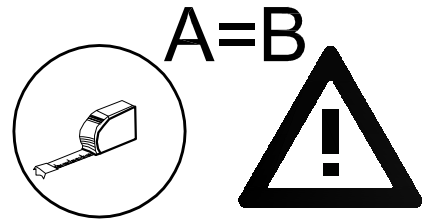
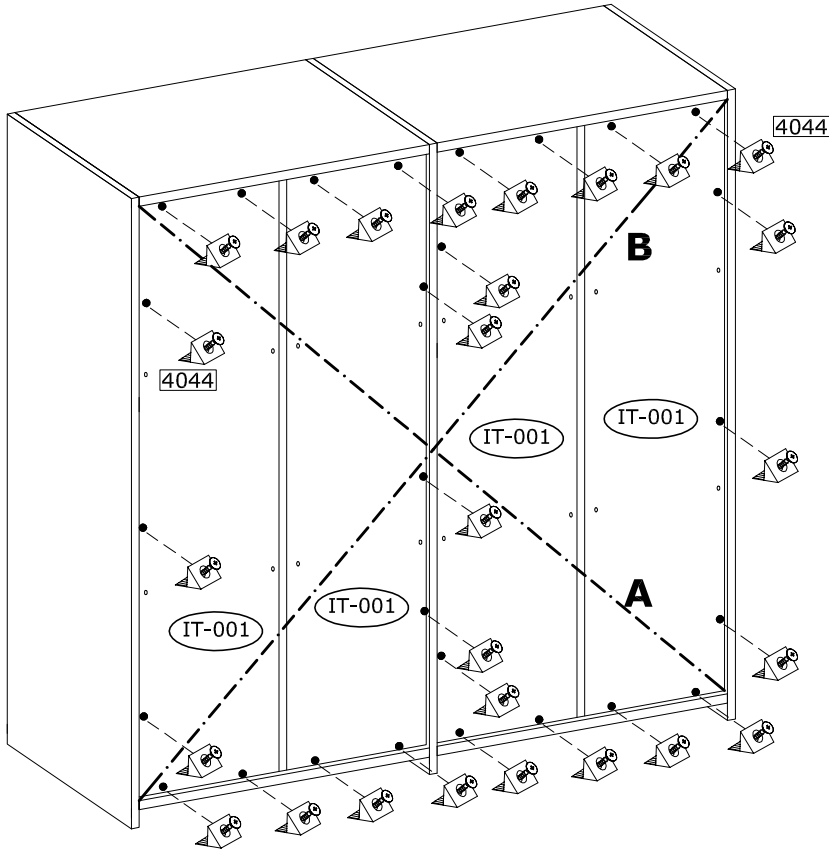

25

x2

136236
x28

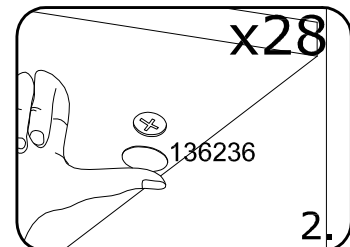
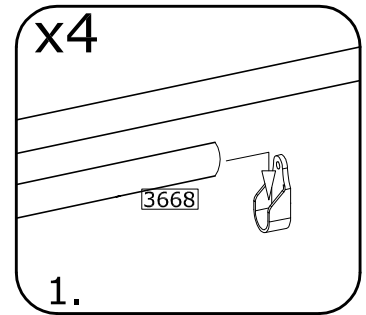
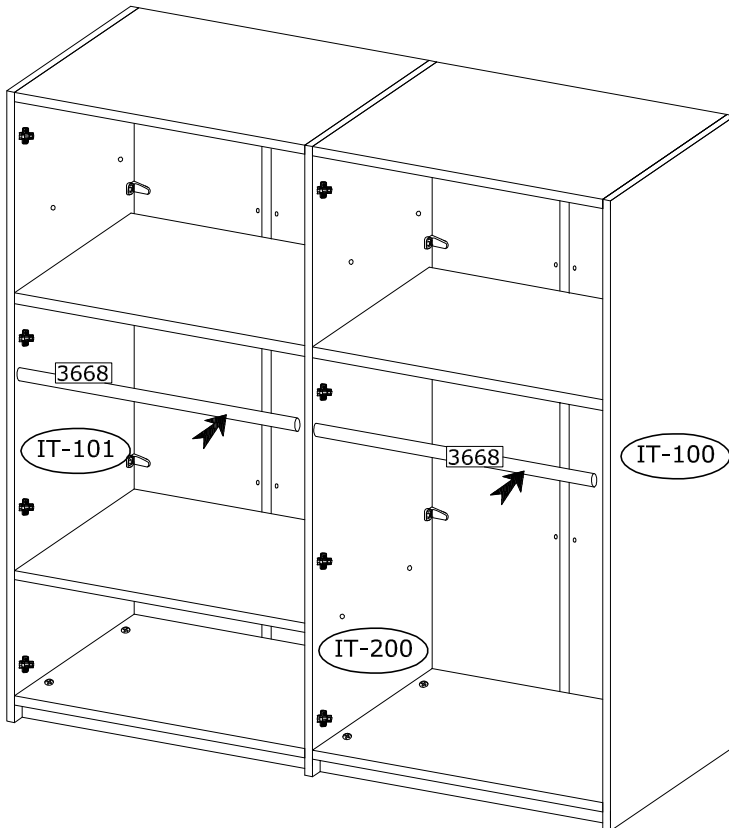

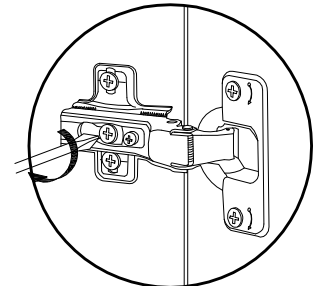
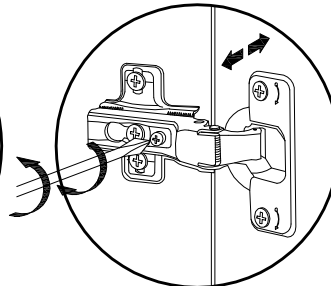
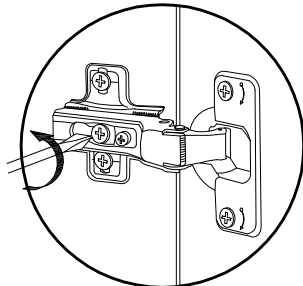
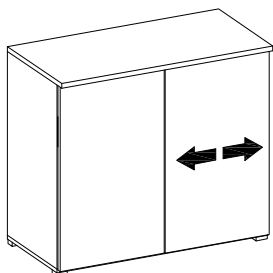
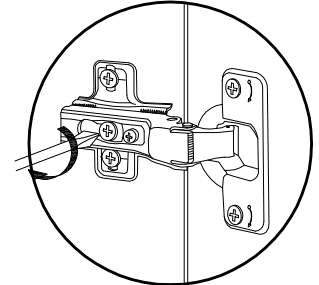
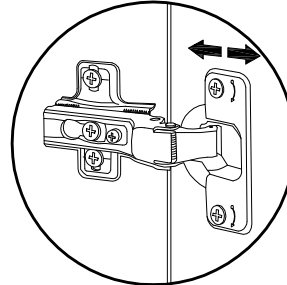
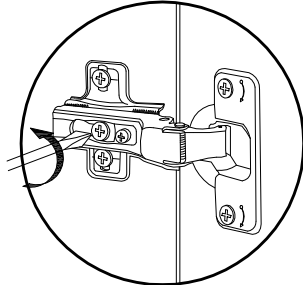
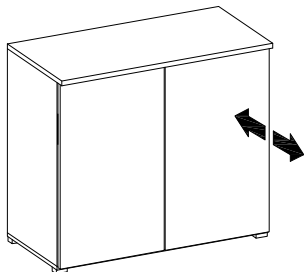
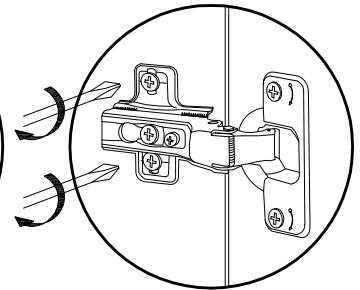
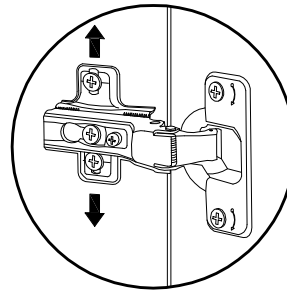
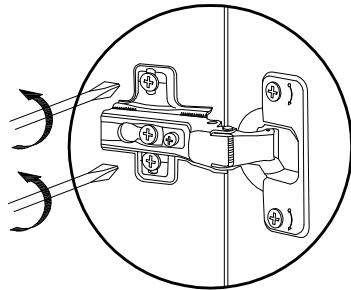
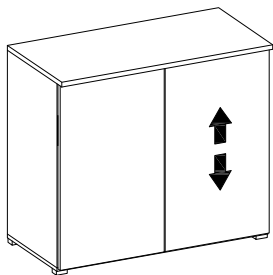
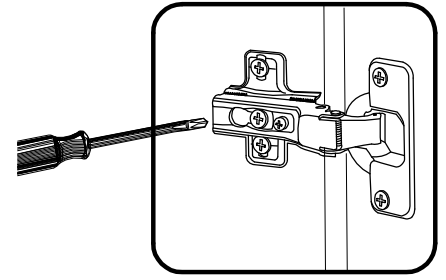
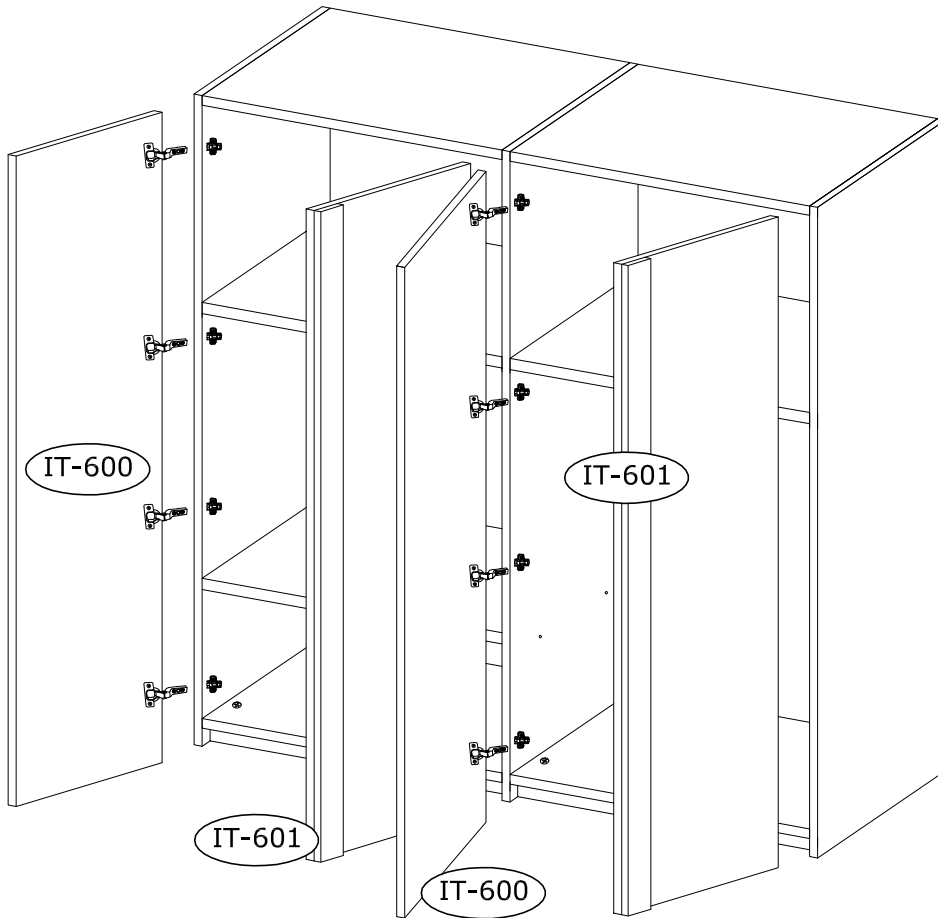
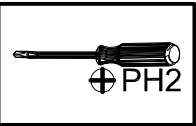

27

71900
x2

3918
x4

