

B-1	1373	395	16	x1	1/2
B-2	1373	395	16	x1	1/2
B-3	632	394	16	x1	2/2
B-4	632	394	16	x1	2/2
B-5	632	345	16	x1	2/2
B-6	1354	646	3	x1	1/2
B-7	666	206	16	x2	1/2
B-8	666	206	16	x4	2/2
B-9	300	120	16	x6	1/2
B-10	300	120	16	x6	1/2
B-11	596	120	16	x6	1/2
B-12	626	306	3	x6	1/2

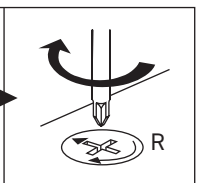

1

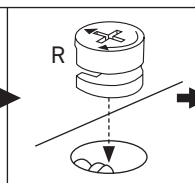
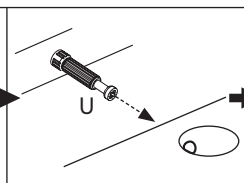
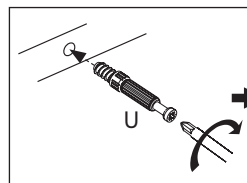
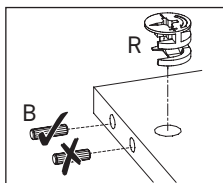
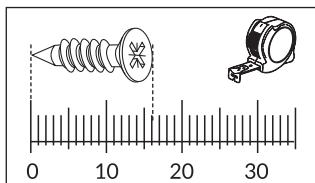
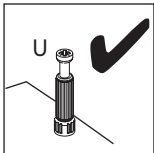
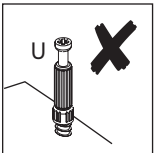
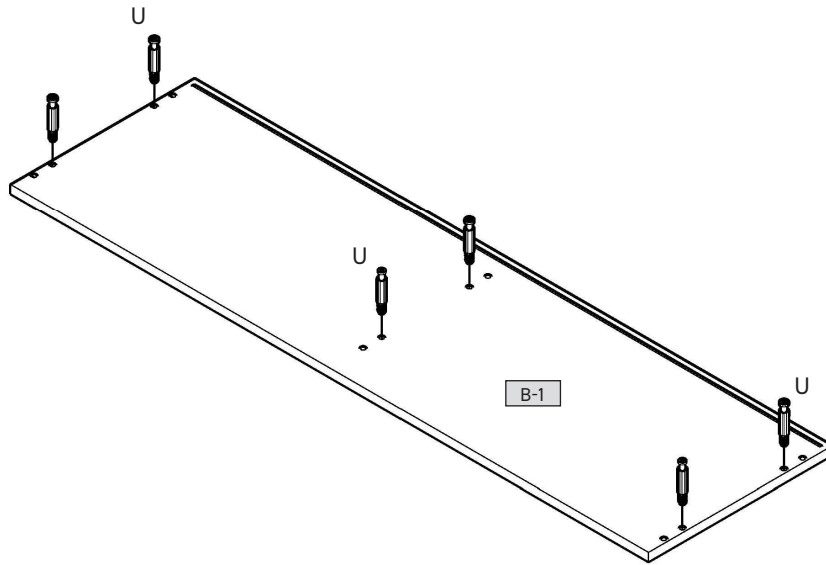
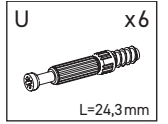

2

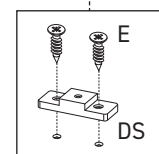
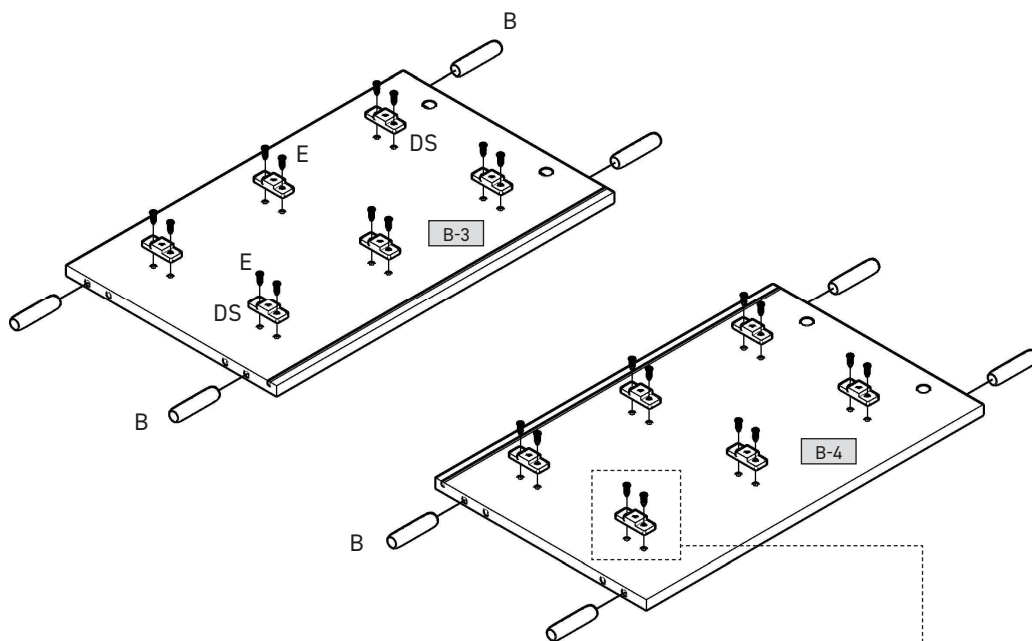
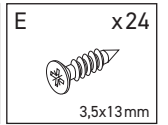
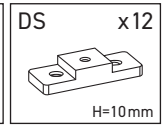
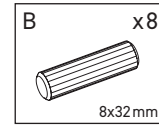

# 3



K6	x3	T3	x12

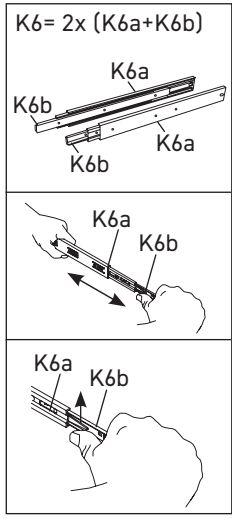
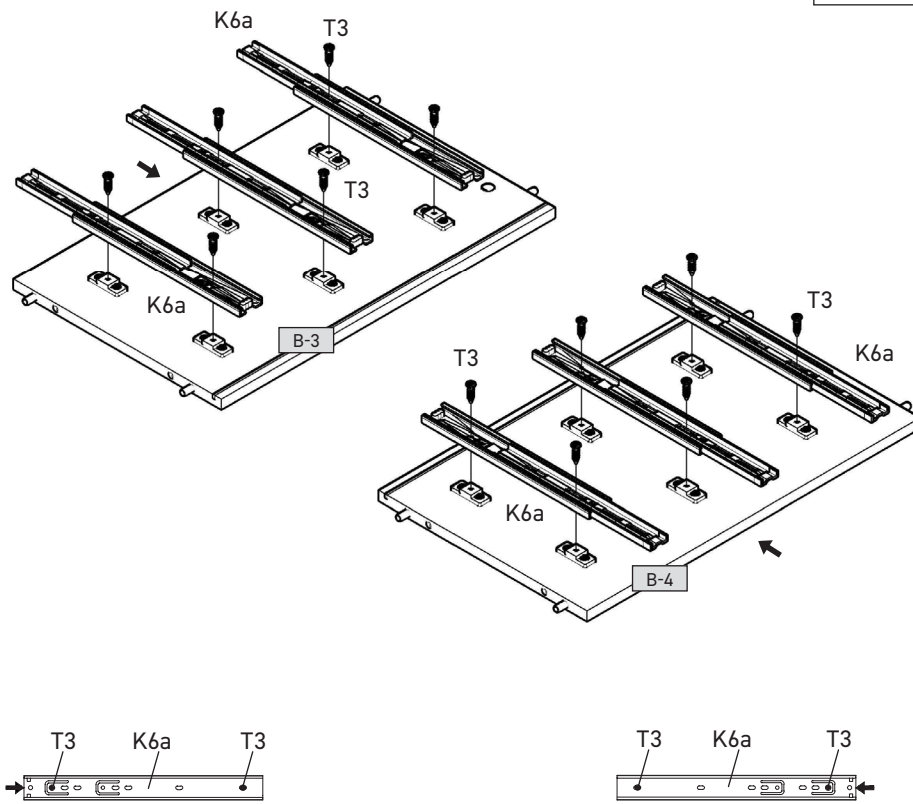

# 4



B	x4	K6	x3	T3	x12

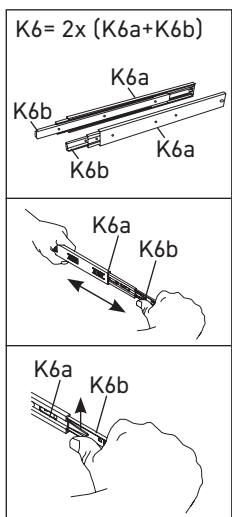
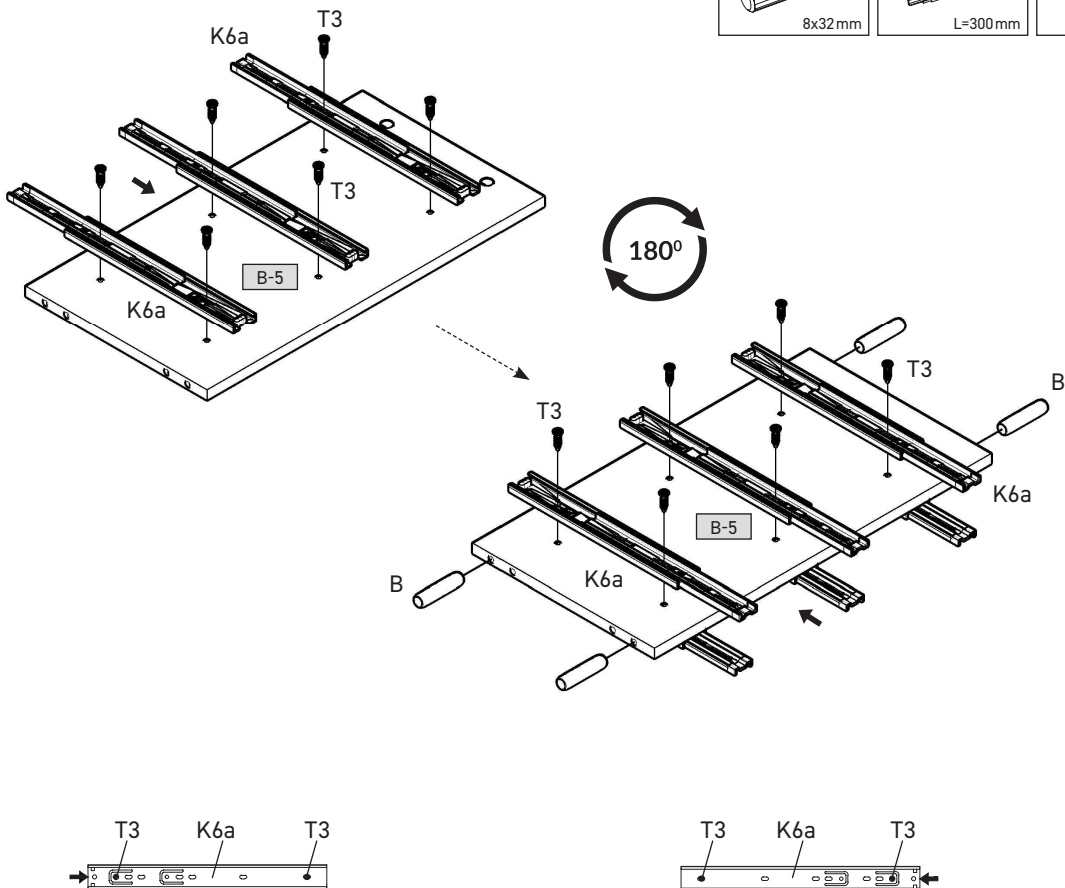

5

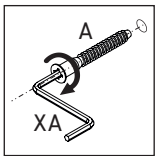
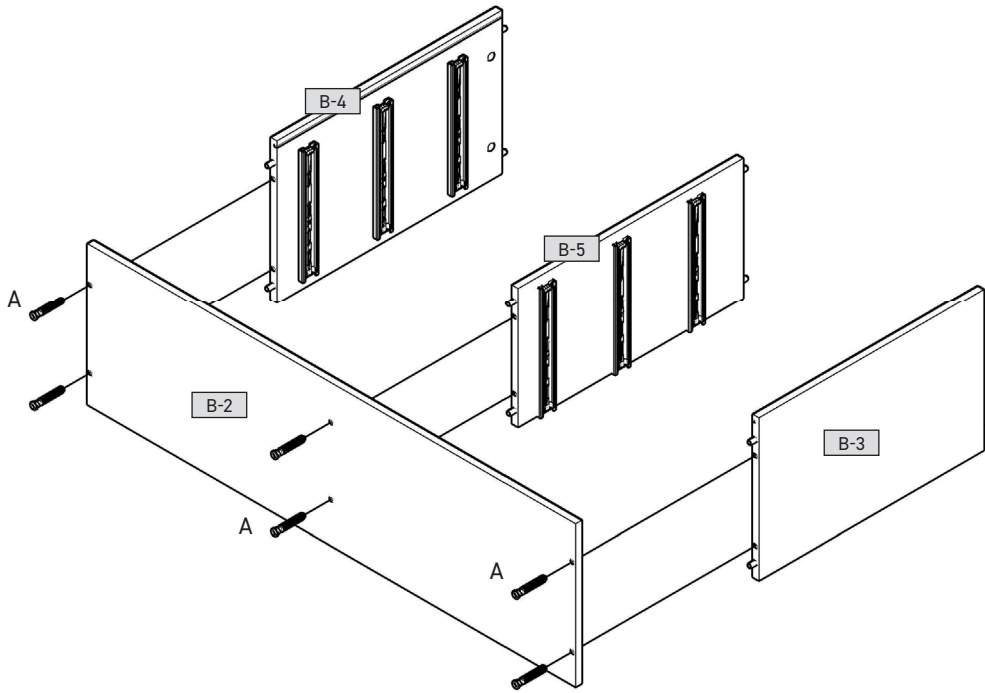
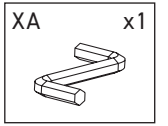
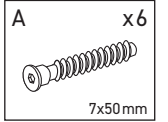

6

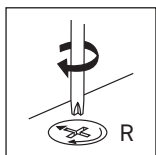
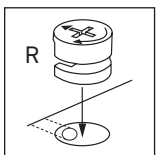
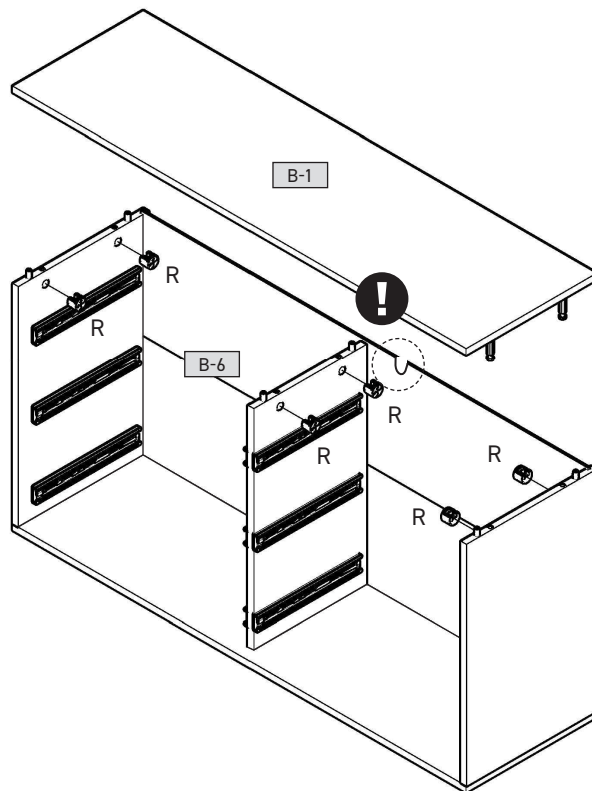
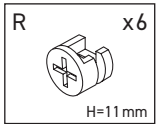

7

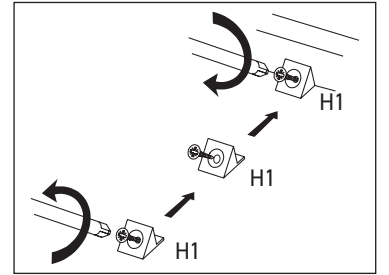
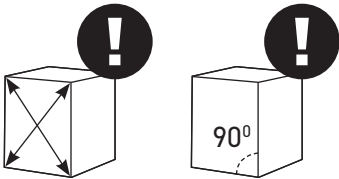
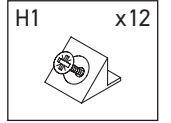
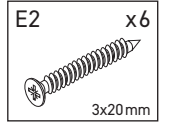
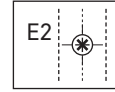
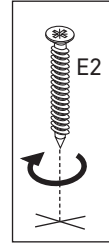
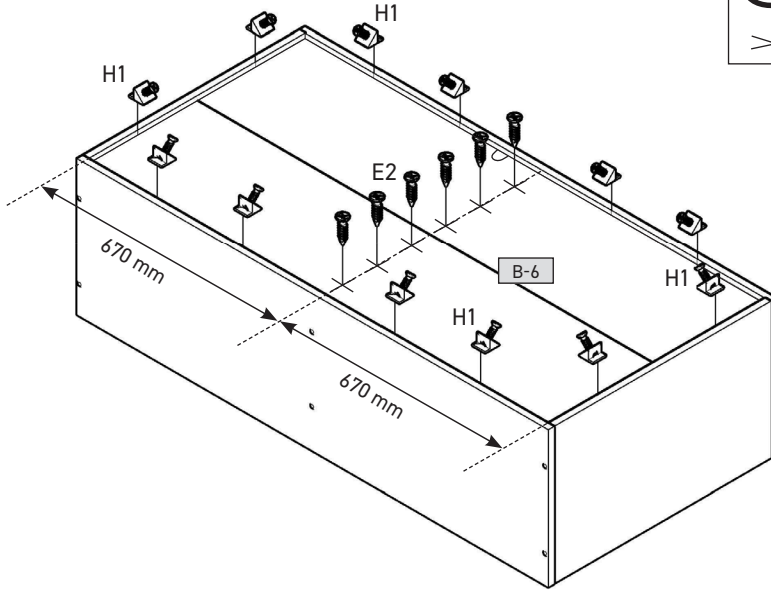

8

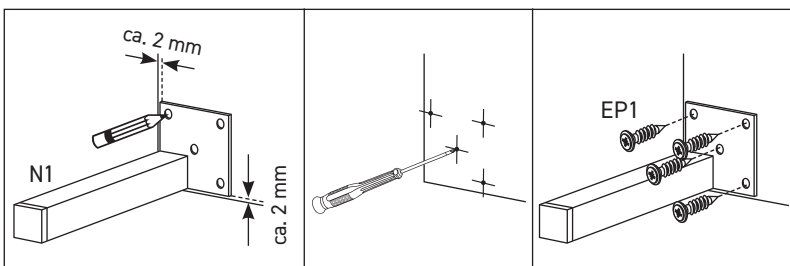
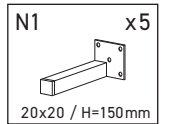
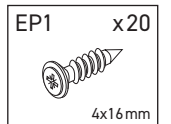
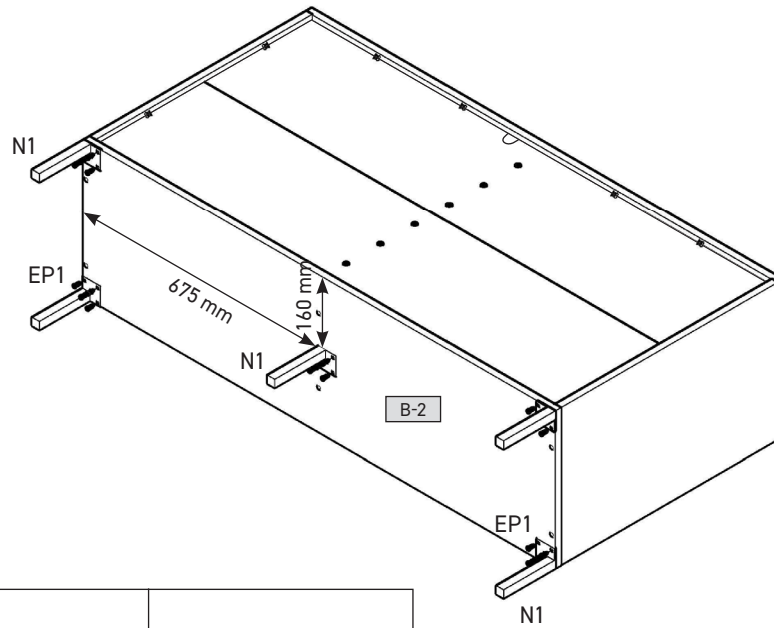

9

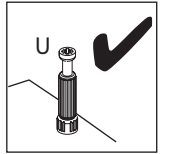
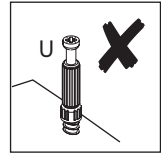
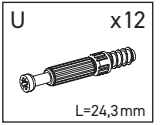
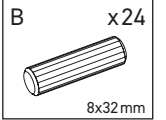
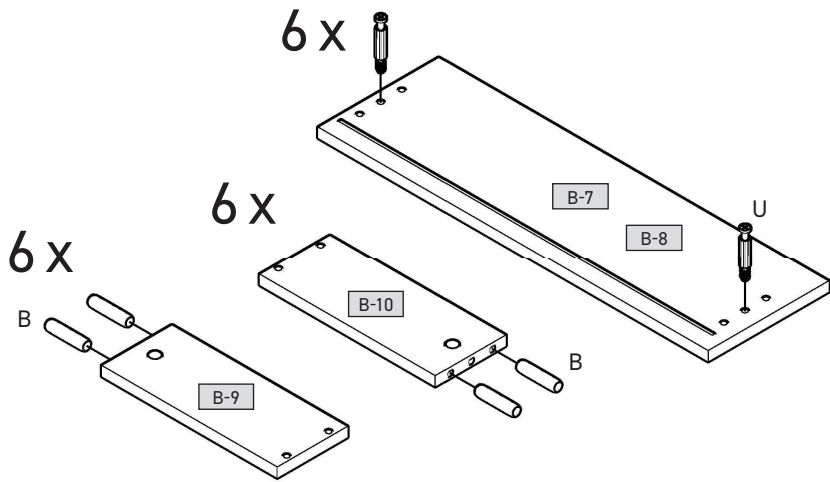

10

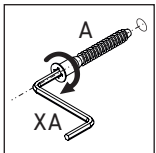
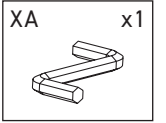
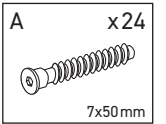
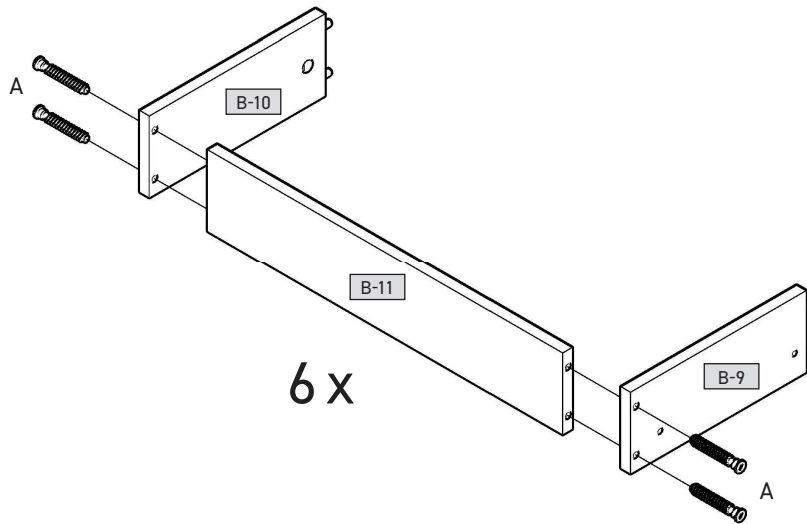

11

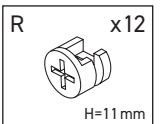
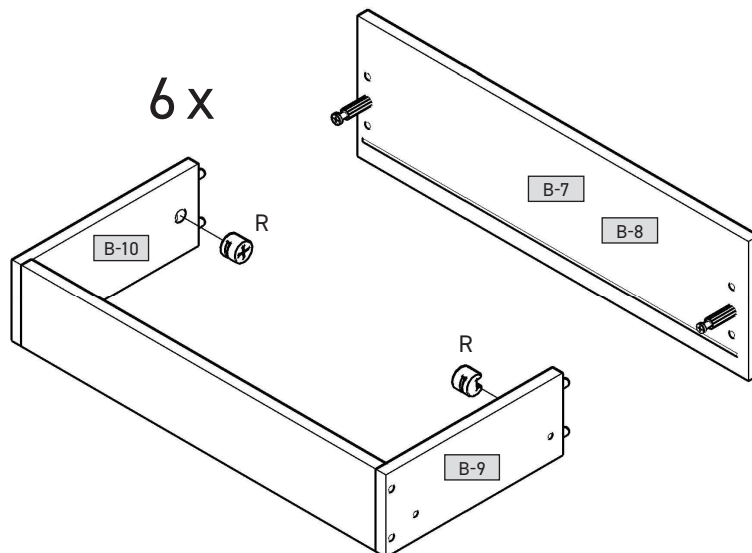
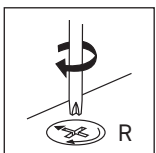
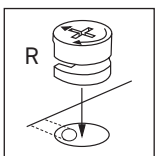



12

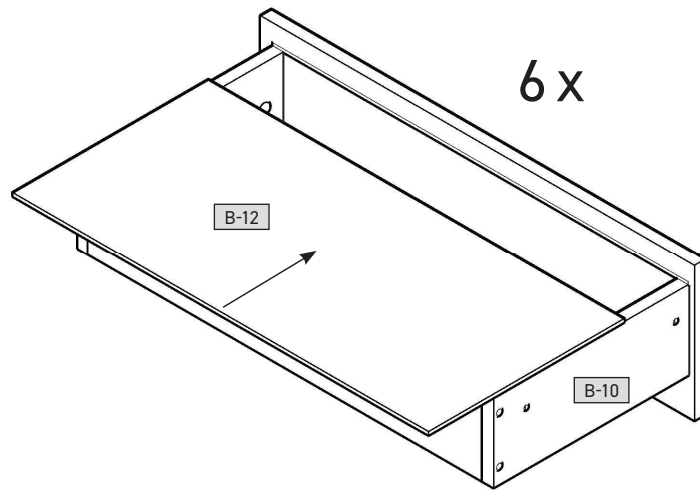

13

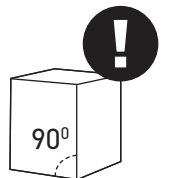
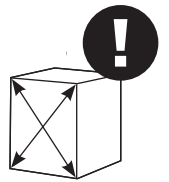
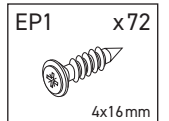
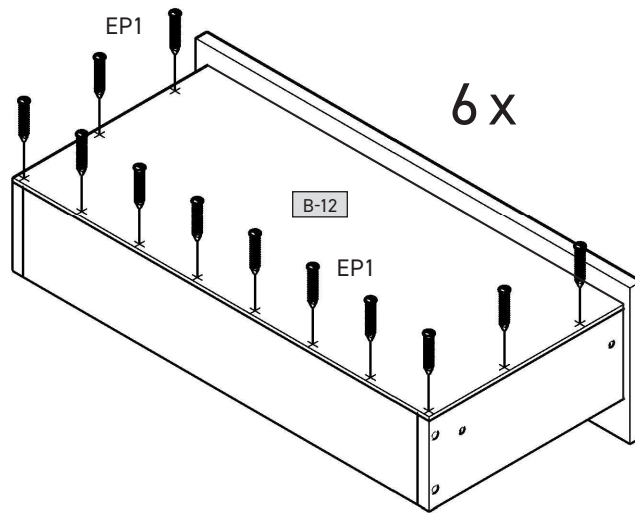
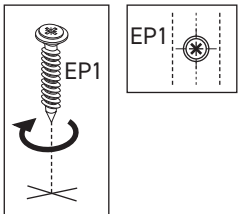
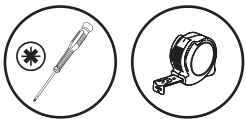

14

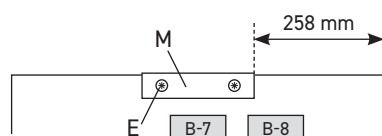
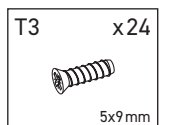
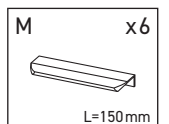
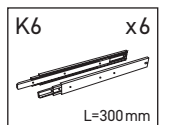
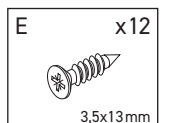
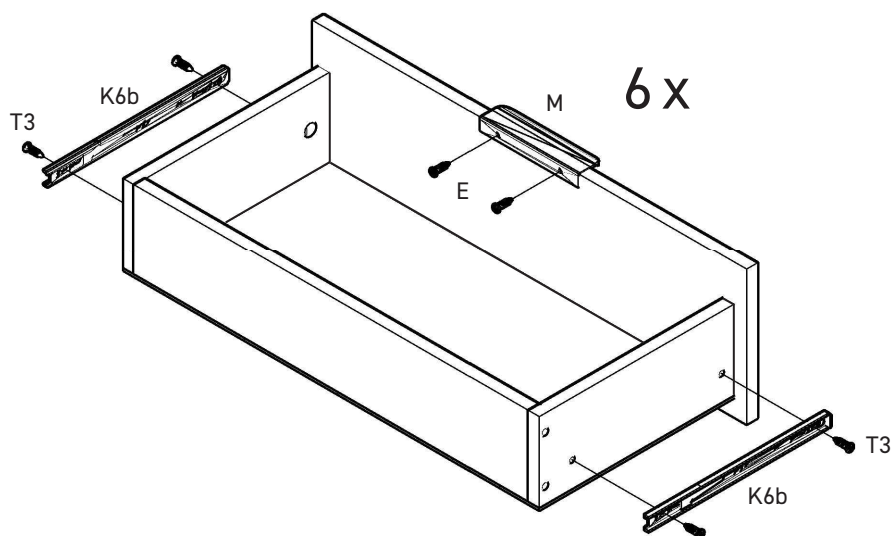
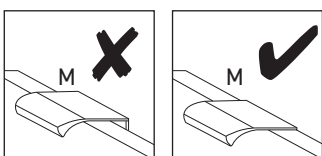
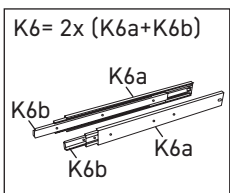
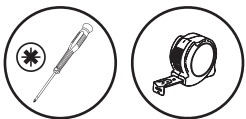

15

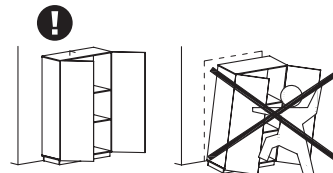
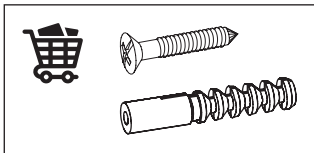
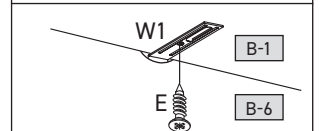
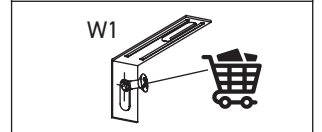
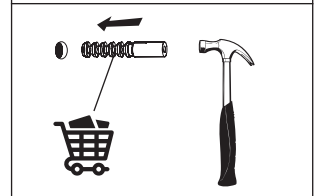
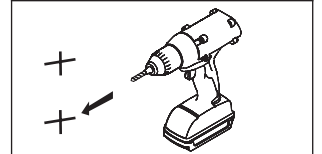
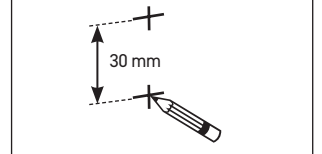
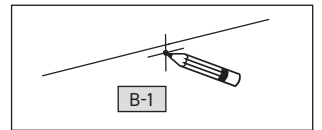
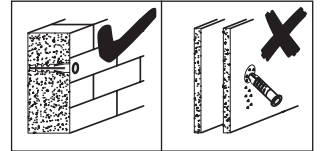
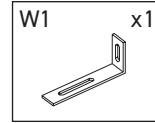
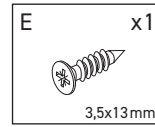
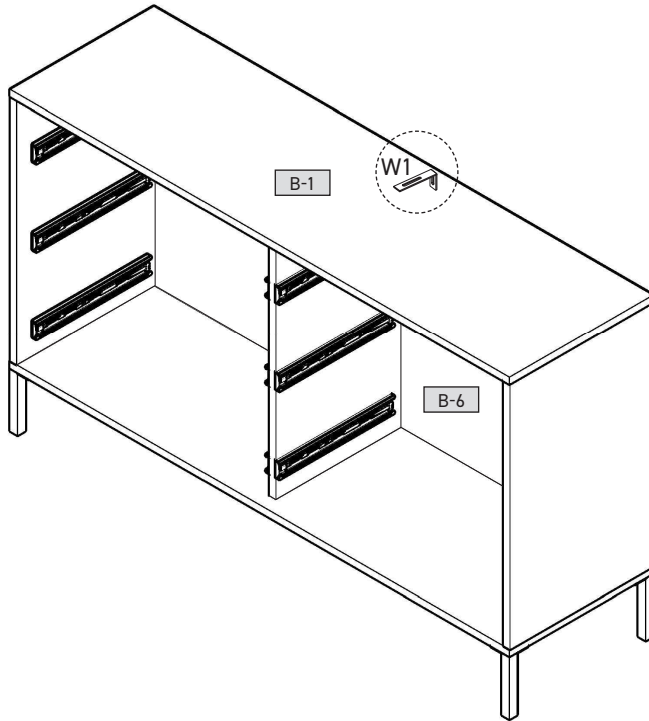

16

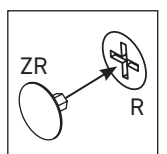
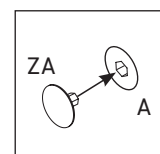
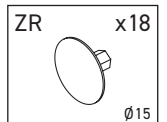
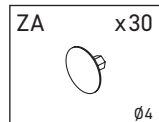
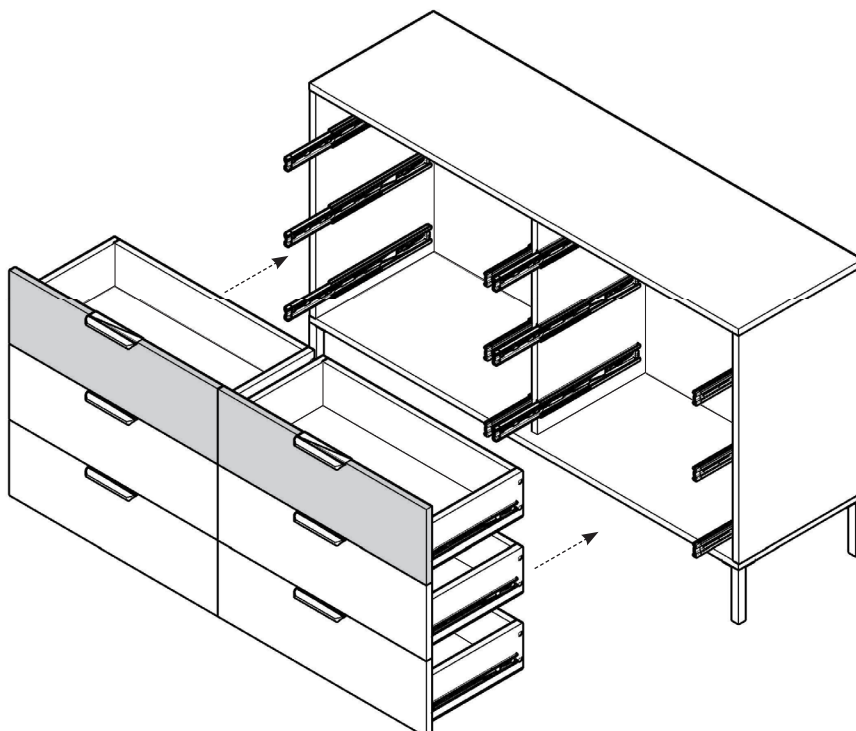

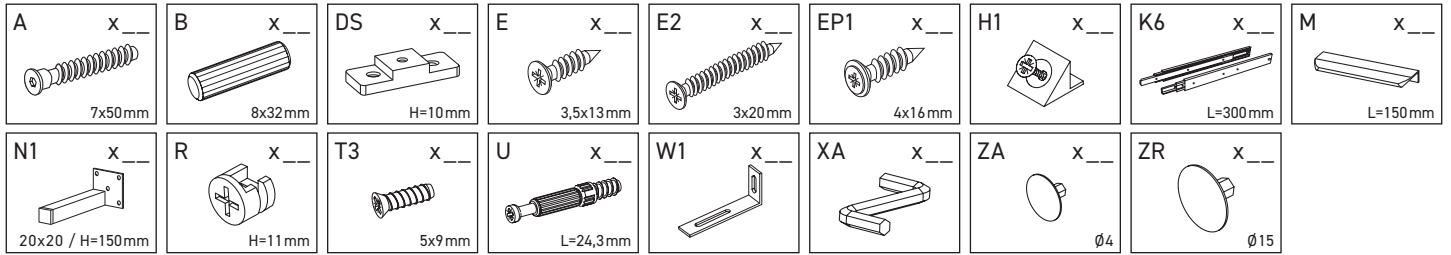

B-1	1373	395	16	x 1	1/2
B-2	1373	395	16	x 1	1/2
B-3	632	394	16	x 1	2/2
B-4	632	394	16	x 1	2/2
B-5	632	345	16	x 1	2/2
B-6	1354	646	3	x 1	1/2
B-7	666	206	16	x 2	1/2
B-8	666	206	16	x 4	2/2
B-9	300	120	16	x 6	1/2
B-10	300	120	16	x 6	1/2
B-11	596	120	16	x 6	1/2
B-12	626	306	3	x 6	1/2

