

100min

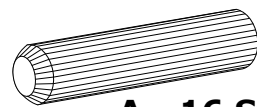

A - 16 St.

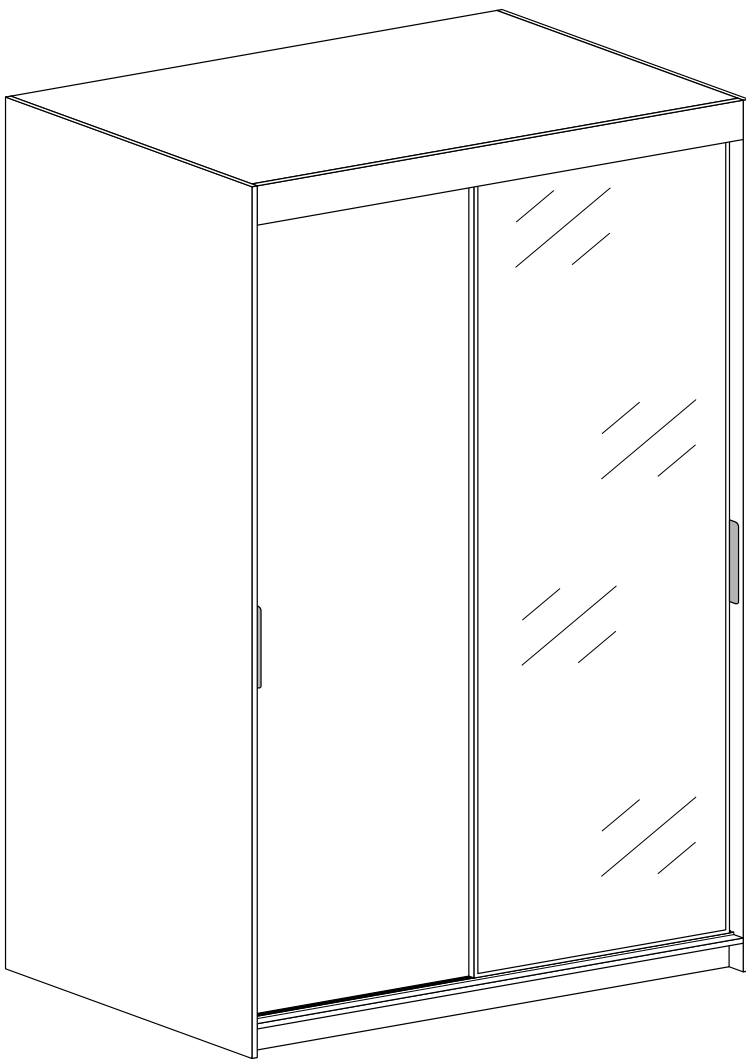
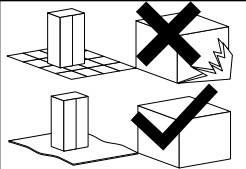
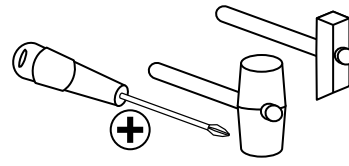
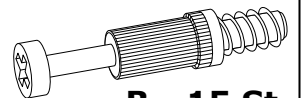

B - 15 St.



C - 15 St.

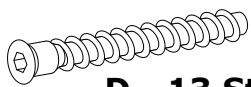

D - 13 St.

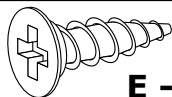

E - 47 St.
3,5x16 mm

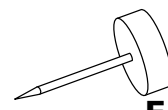

F - 7 St.

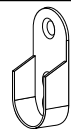

G - 2 St.

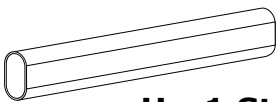

H - 1 St.



I - 120 St.



J - 4 St.

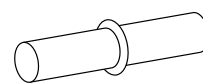

K - 12 St.

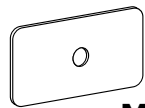

M - 15 St.



N - 4 St.

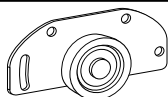

O - 4 St.



P - 4 St.

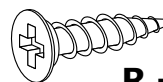

R - 20 St.
3,0x16 mm



U - 2 St.

I

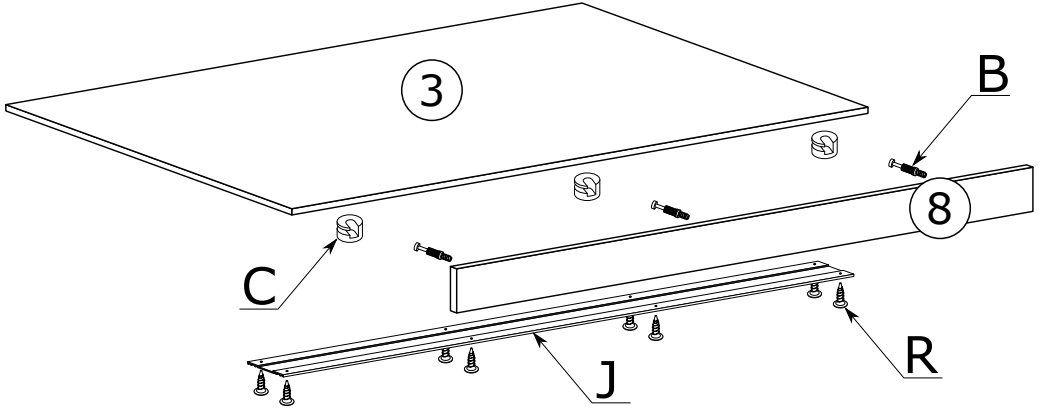

II

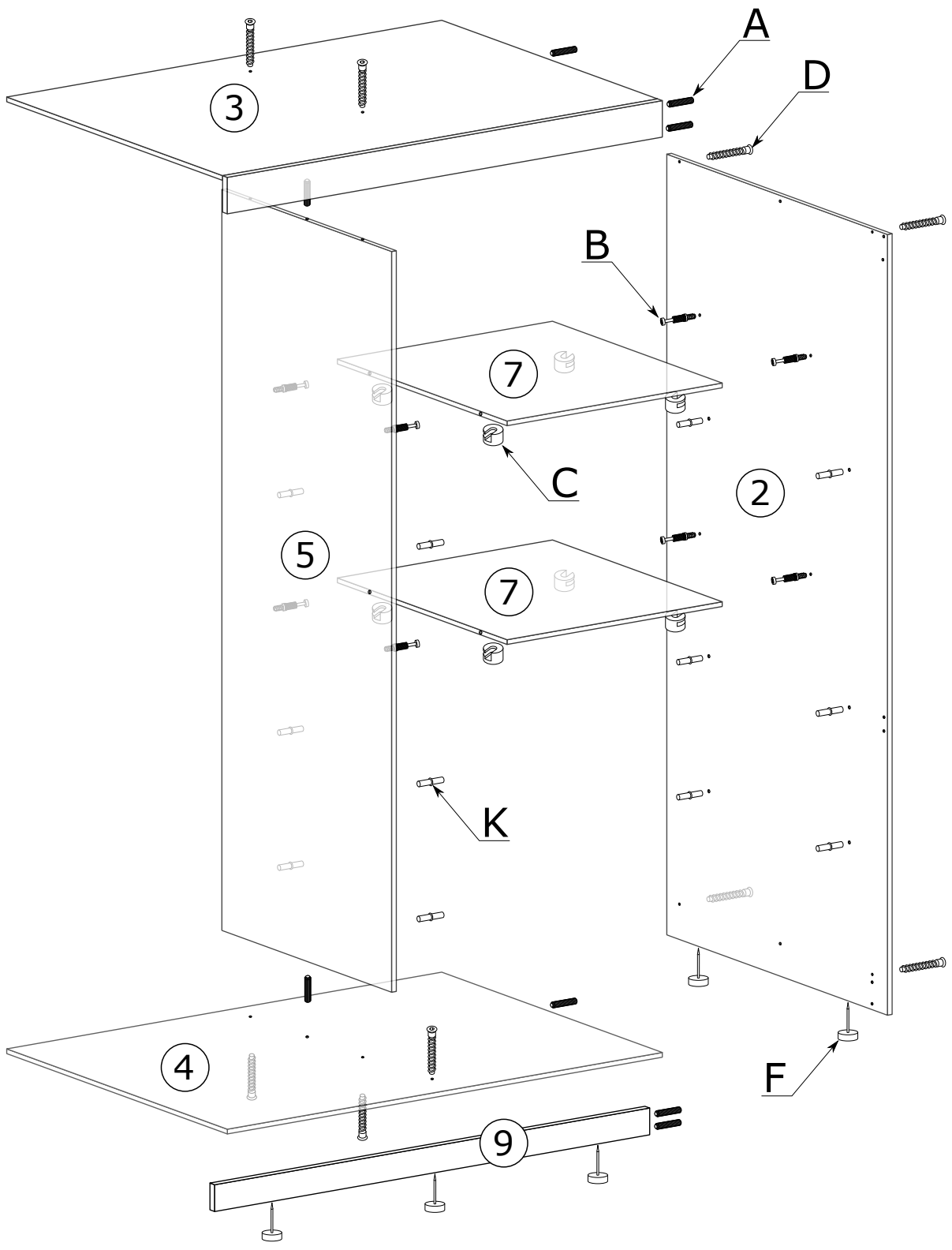

III

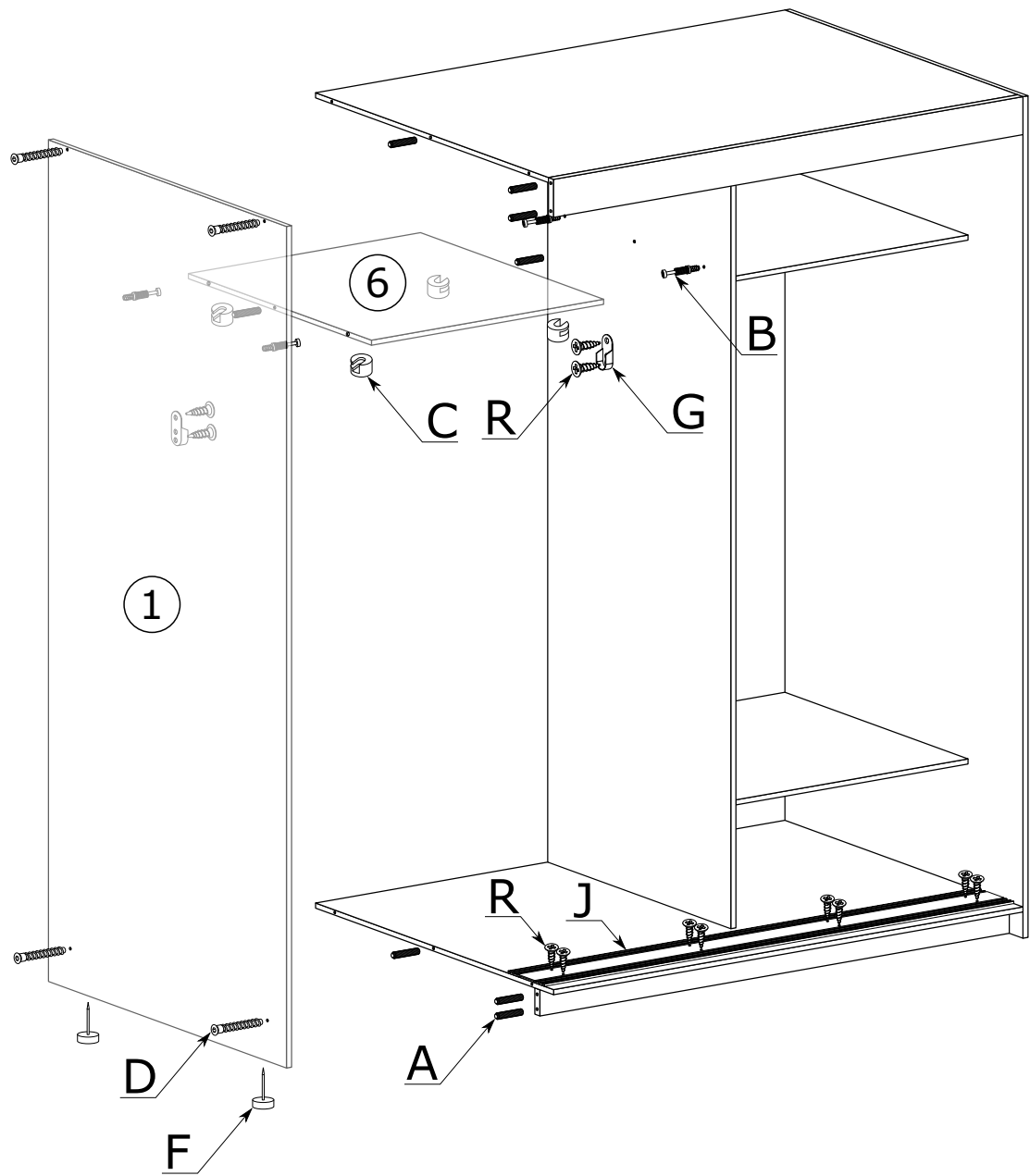

IV

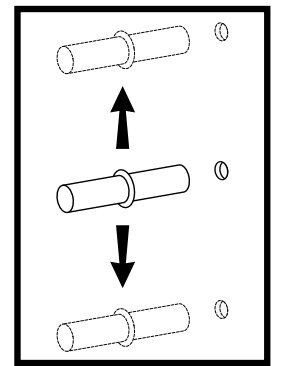
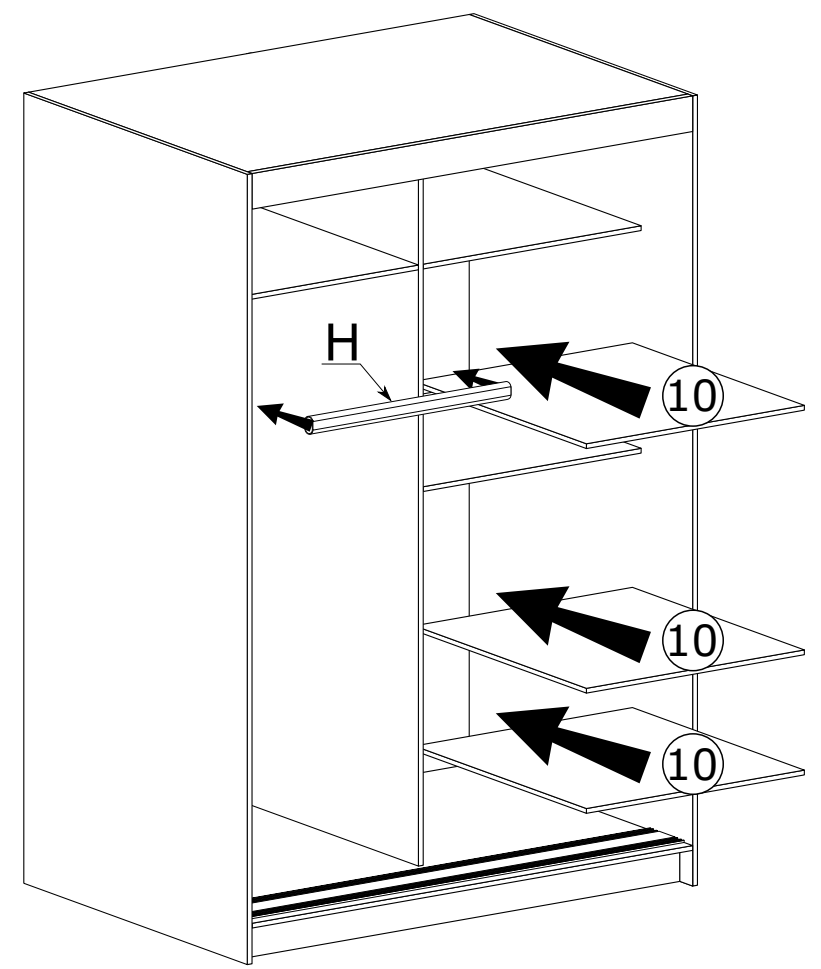

V

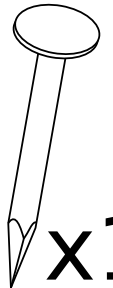
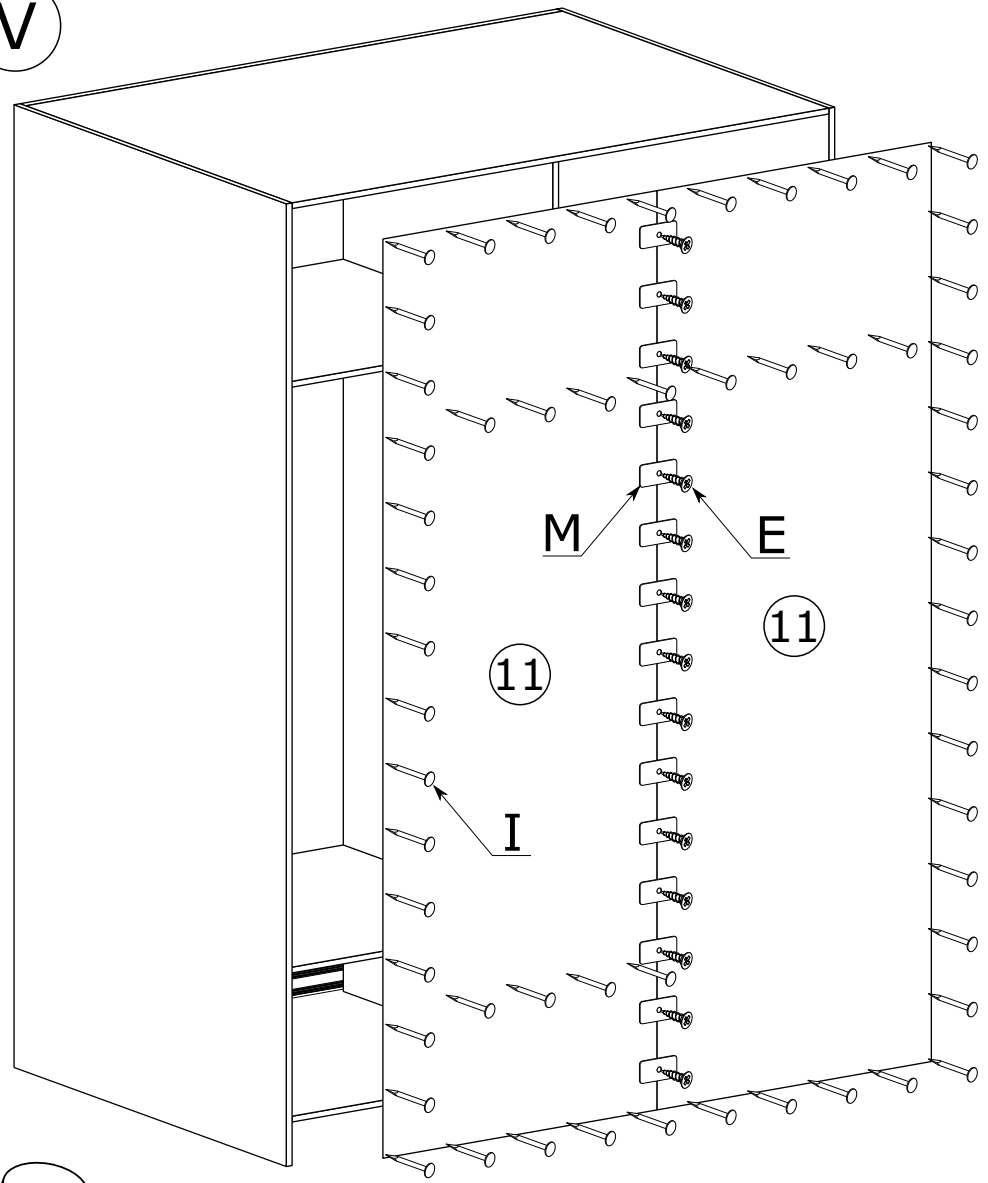

x120

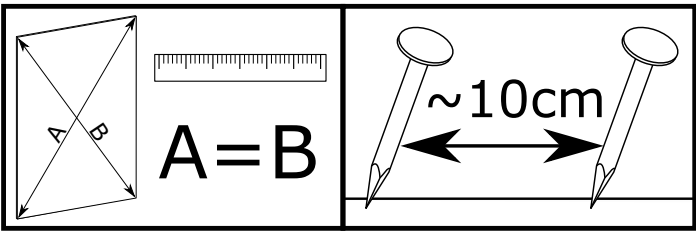

VI

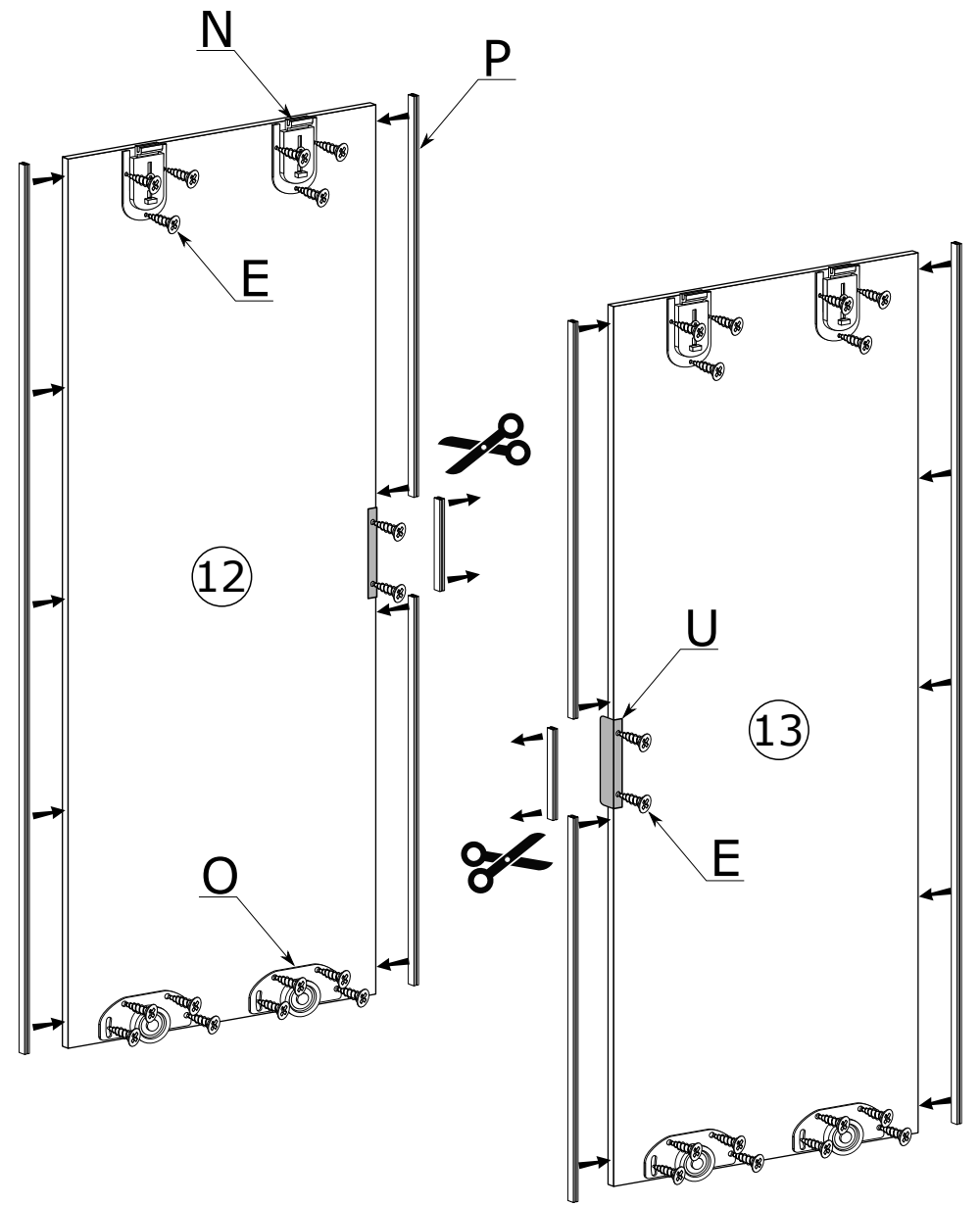

VII

