

100

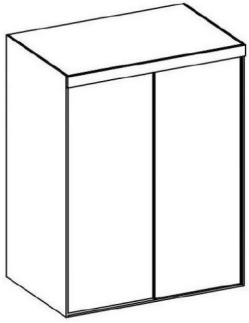

20	28	1	100-110
4	4	64	2
1	8	12	8
4	2	6	4

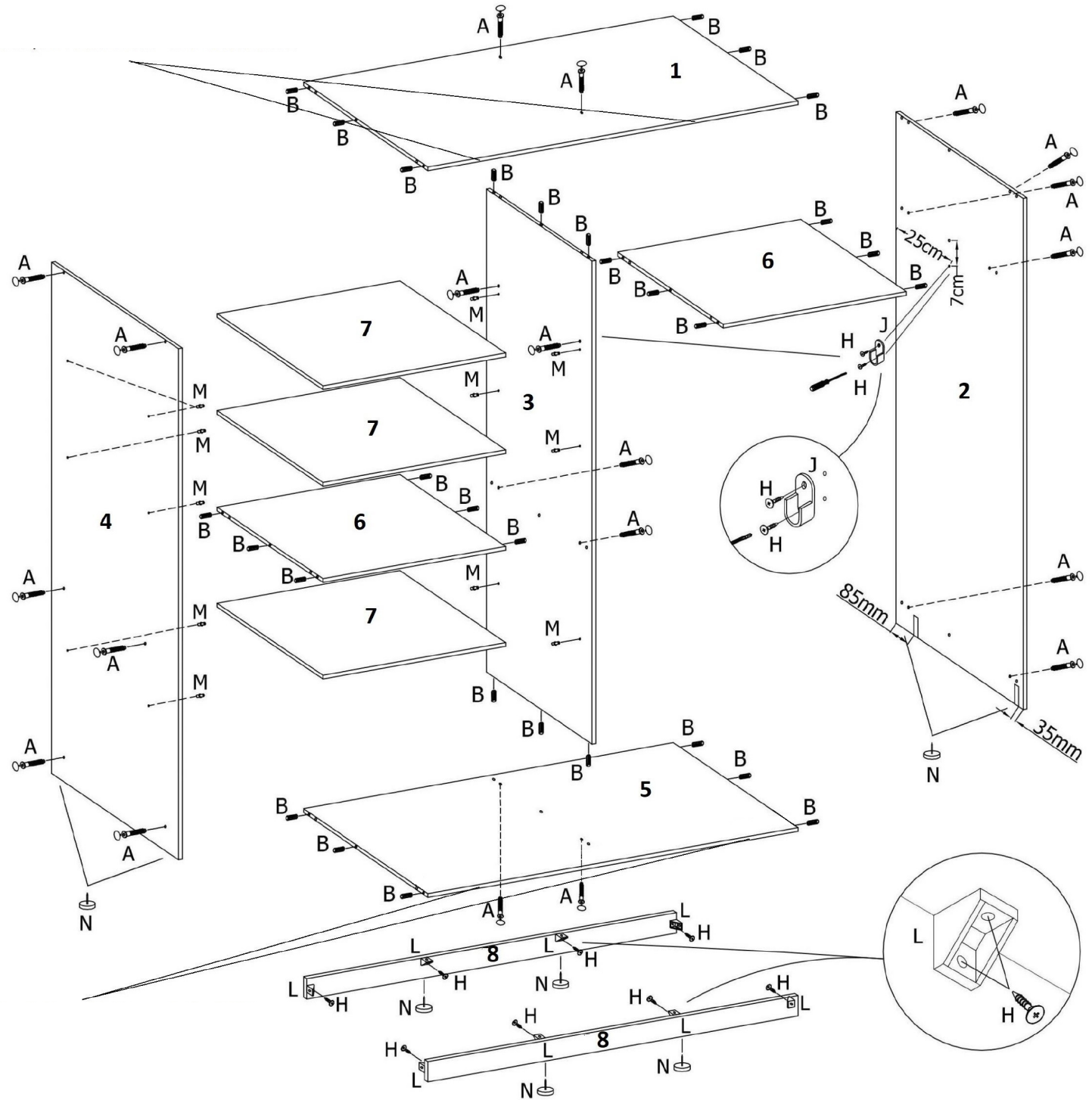

100

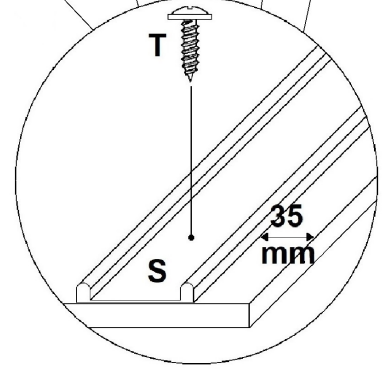
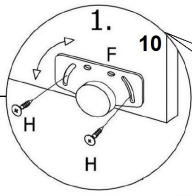
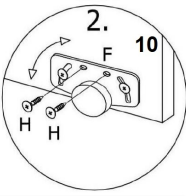
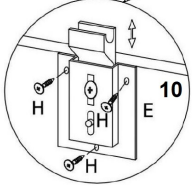
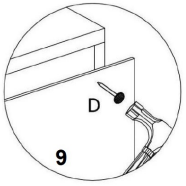
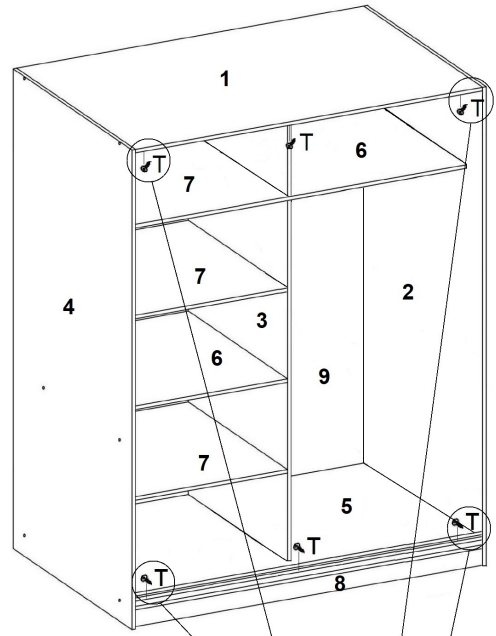
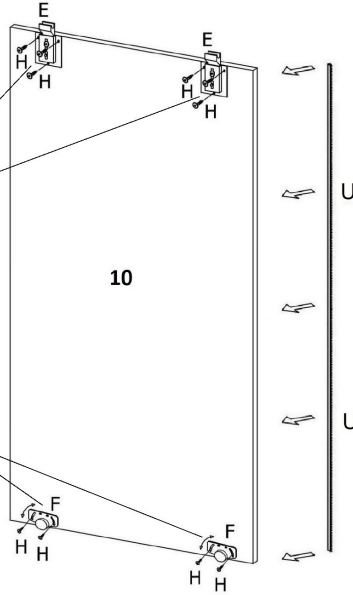
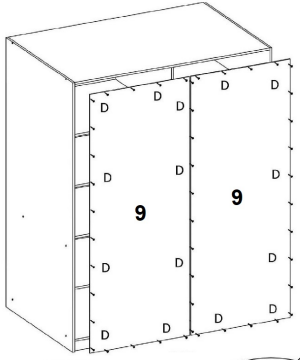
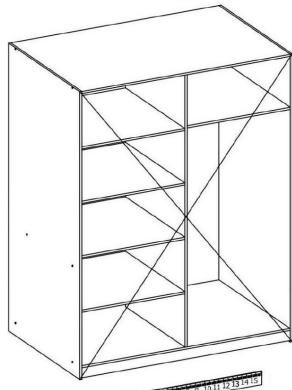
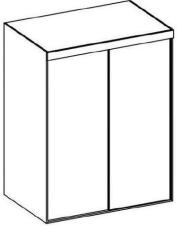



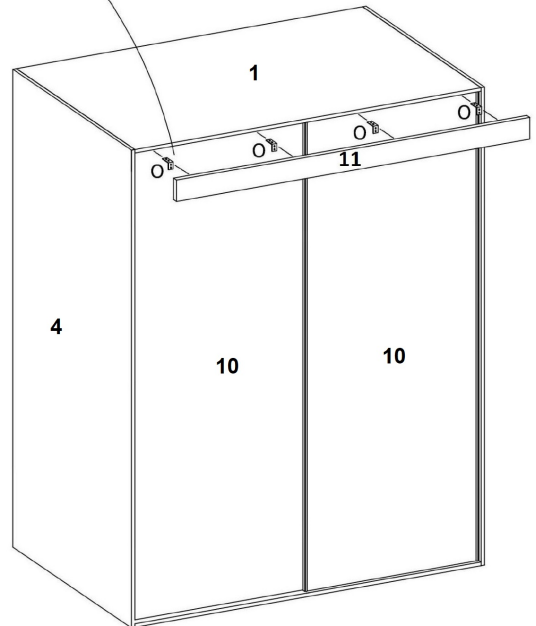
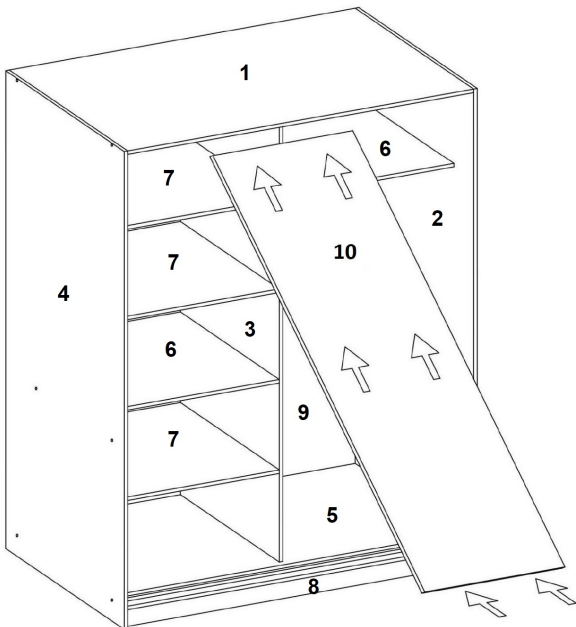
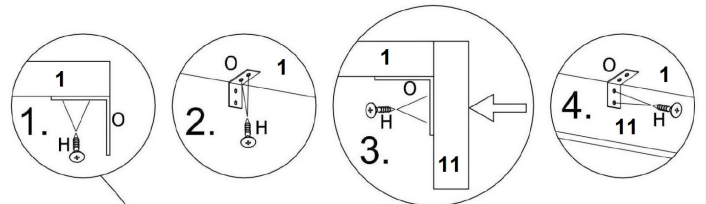
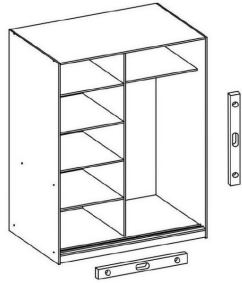
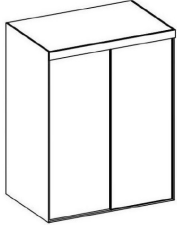



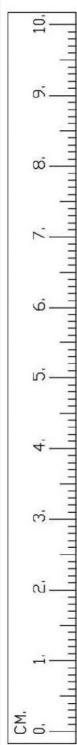
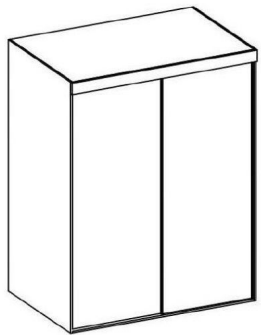

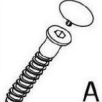
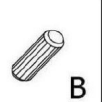
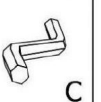

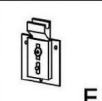
100

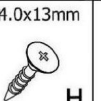

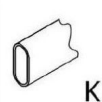
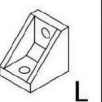
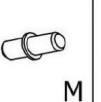
150

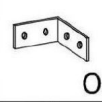
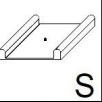
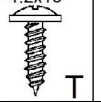

			
20	28	1	100-110
		 4.0x13mm	
4	4	64	2
			
1	8	12	8
		 4.2x13	
4	2	10	4

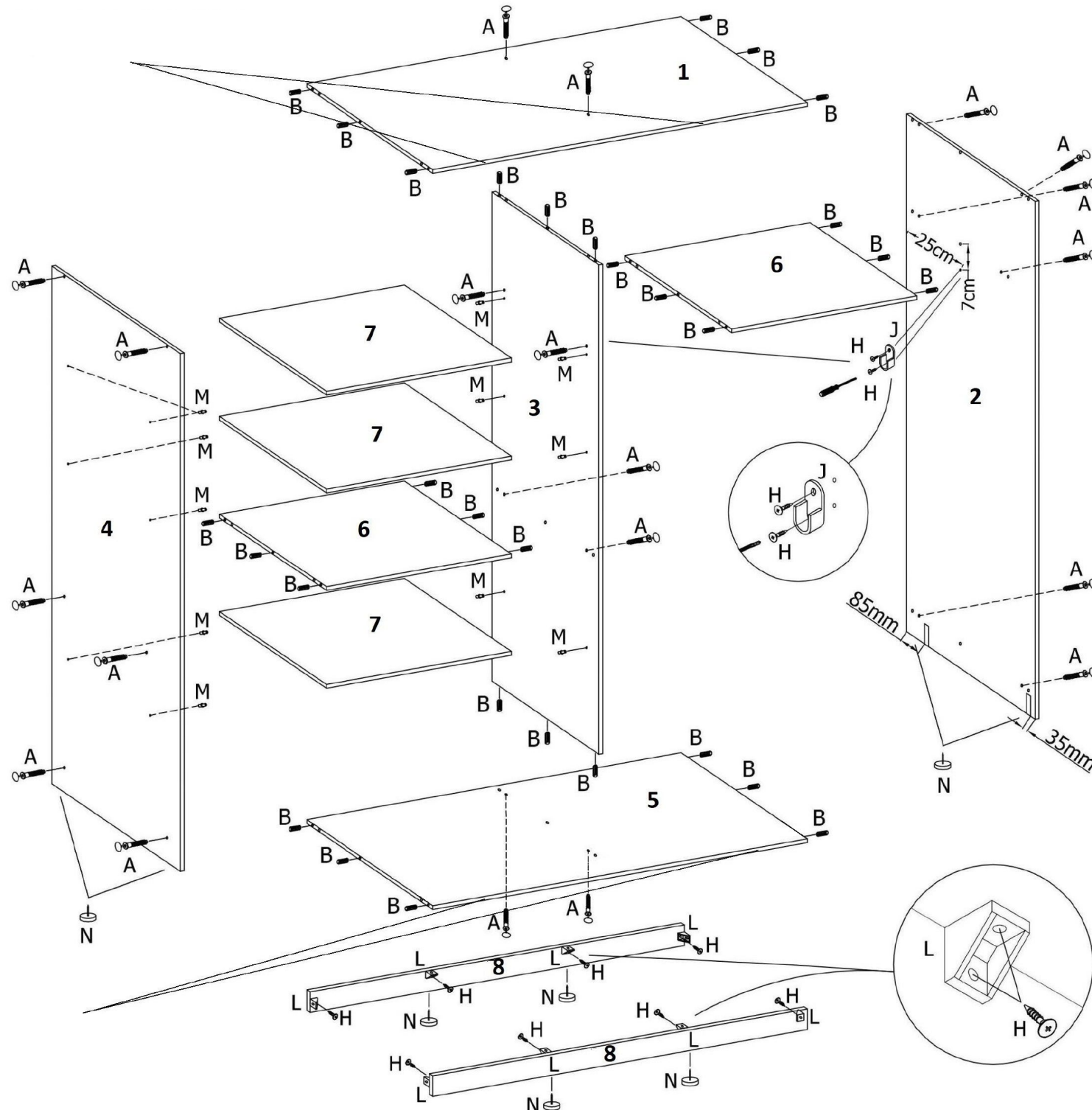

150

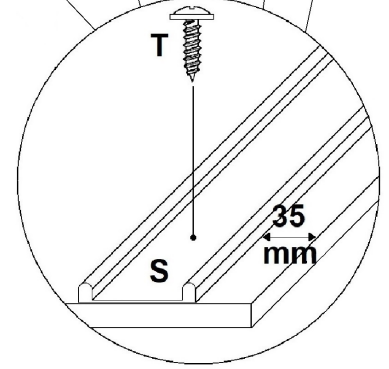
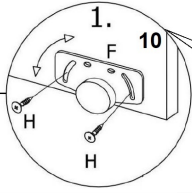
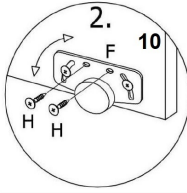
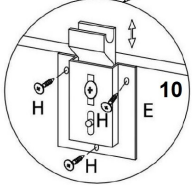
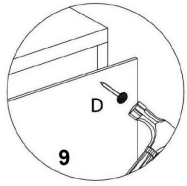
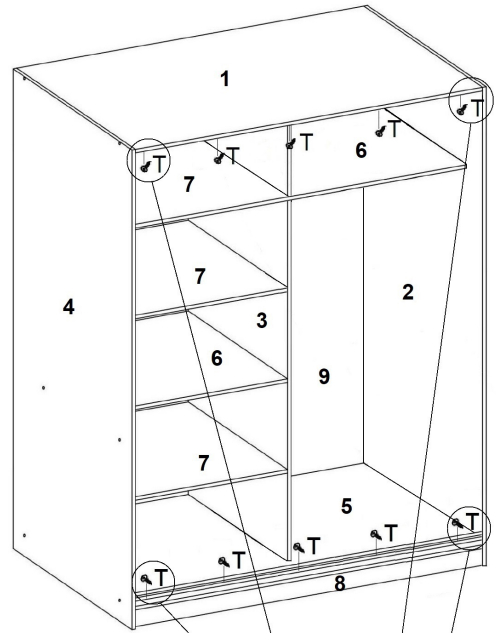
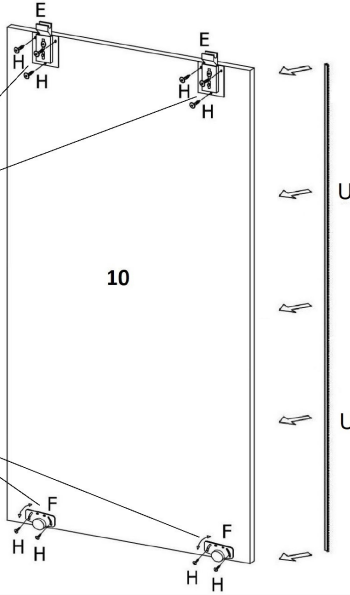
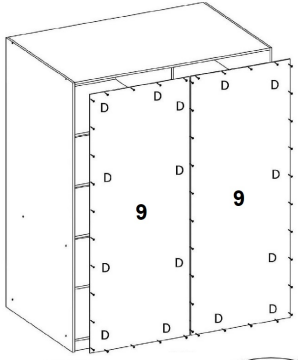
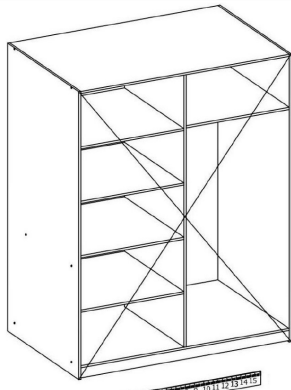
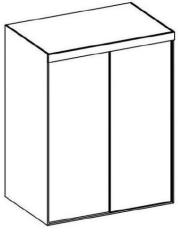

150

