

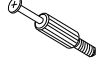

















36	36	36	16	12	14	1	4
							
B	A	8.0x35	D	3.5x16	W2	G	
							
X	L-350	PK	3.0x20	W1	3.5x25	W10	S3
20	2	8	4	4	2	1	

1	4	4
		
U1	US	4.0x35
		W11



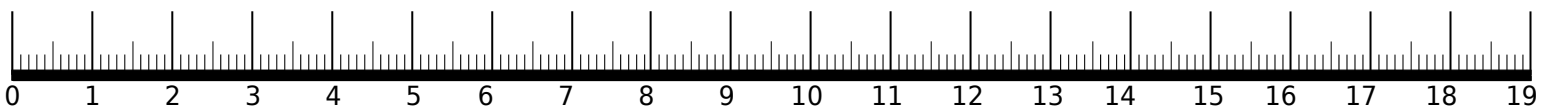
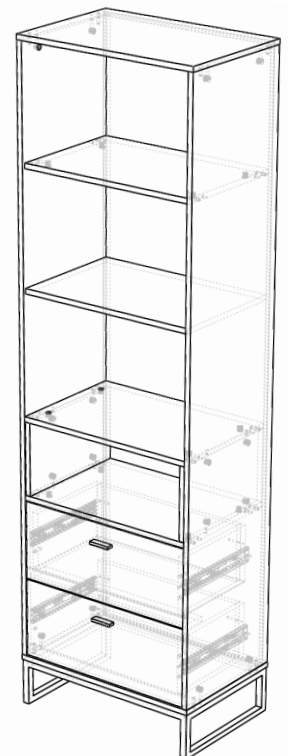
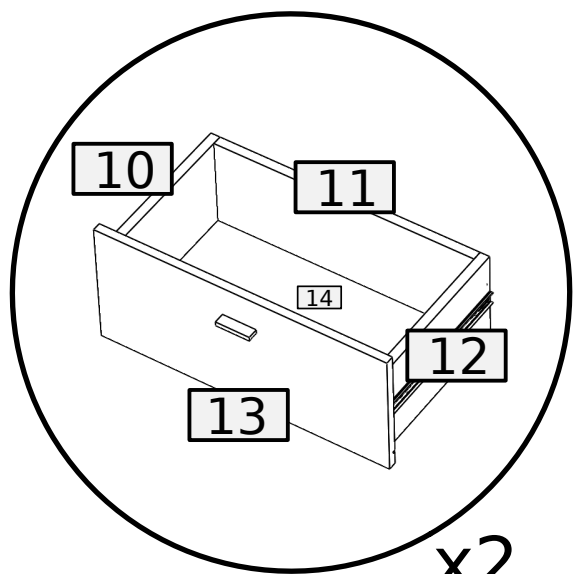

x2

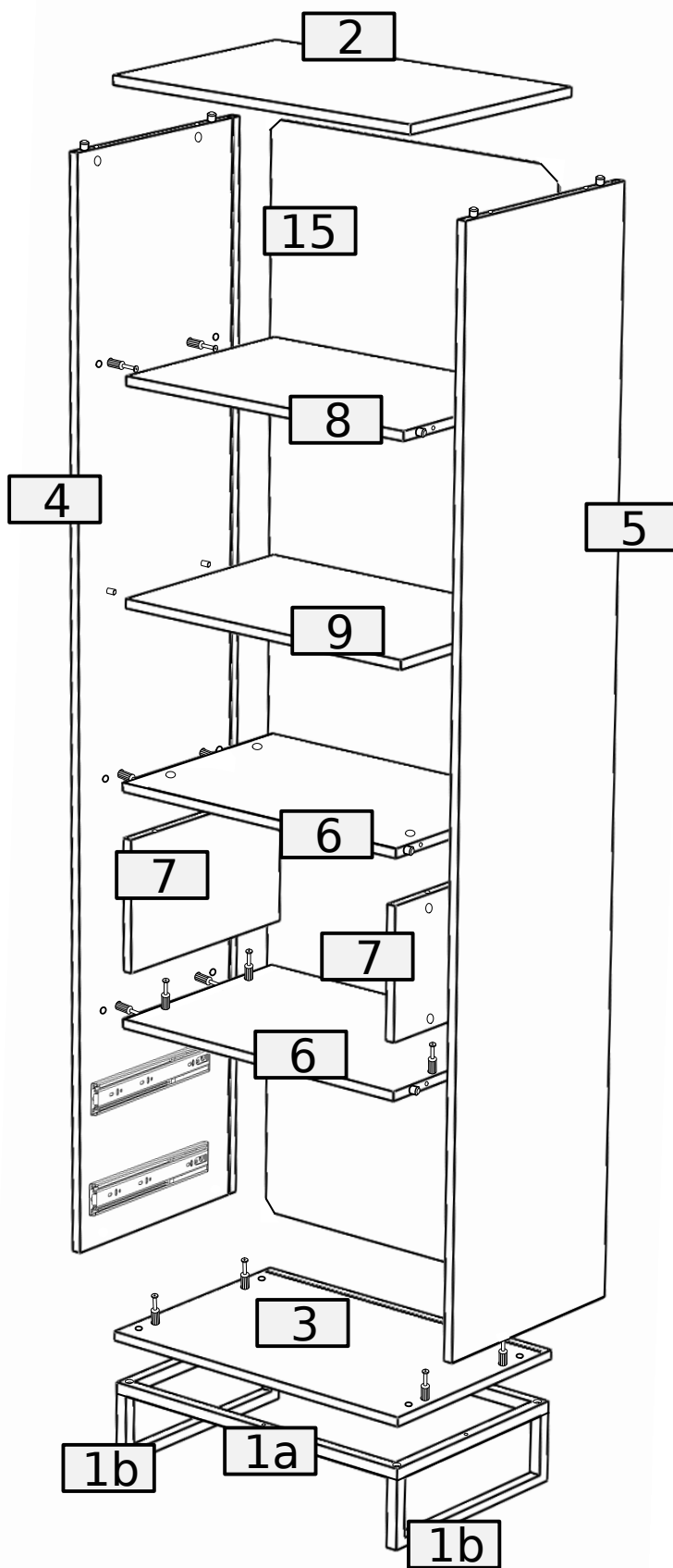

No.	Pcs.	L	W	D	Pac
1a	1	595	395	20	2/2
1b	1	395	140	20	2/2
2	1	600	400	16	1/2
3	1	600	400	16	1/2
4	1	1848	398	16	1/2
5	1	1848	398	16	1/2
6	2	566	377	16	2/2
7	2	376	224	16	2/2
8	1	566	377	16	2/2
9	1	566	370	16	1/2
10	1	350	160	16	2/2
11	2	508	142	16	2/2
12	2	350	160	16	2/2
13	2	562	240	16	2/2
14	2	523	357	3	2/2
15	1	1862	580	3	1/2

①

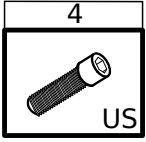
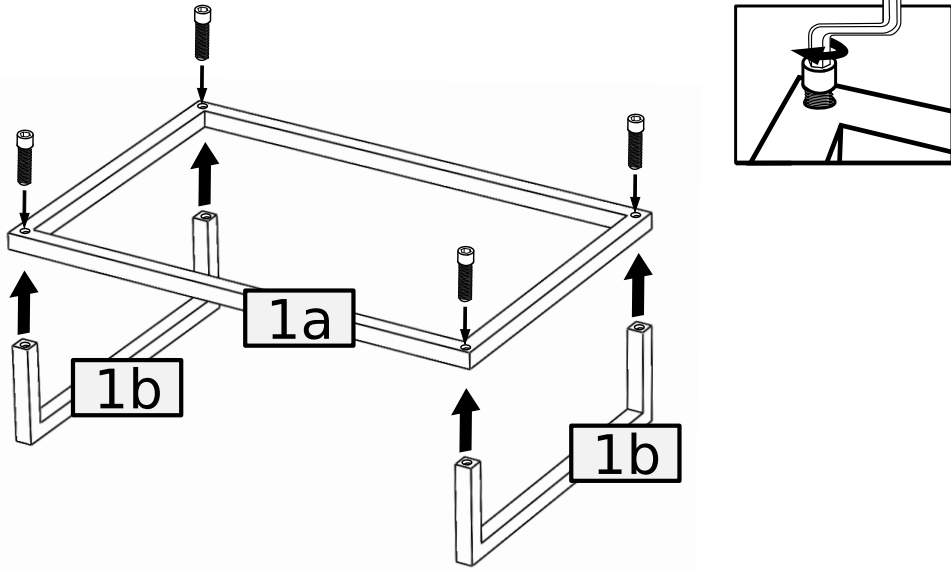

②

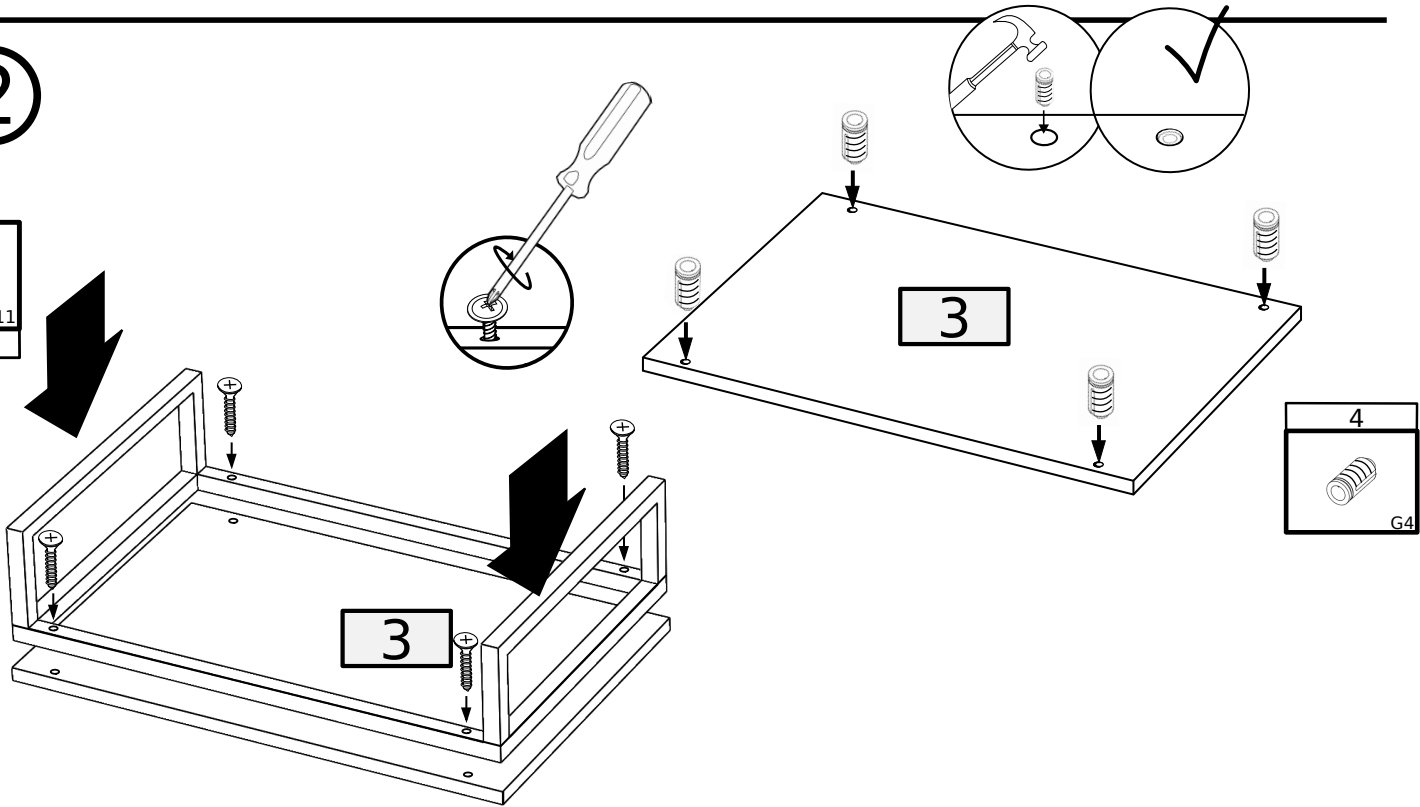
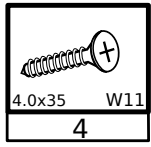

③

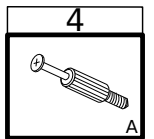
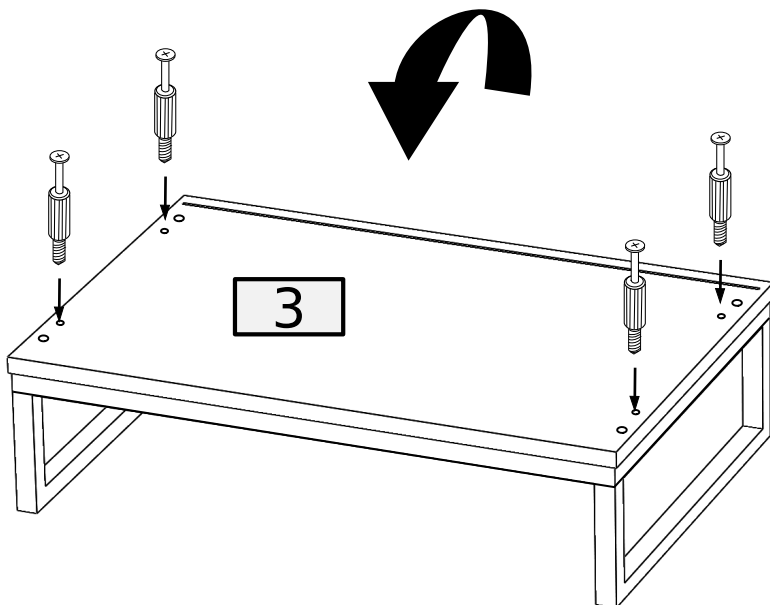

④ x2

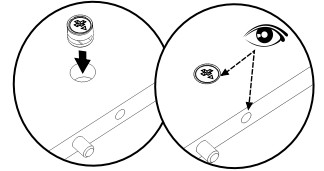
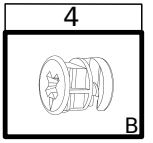
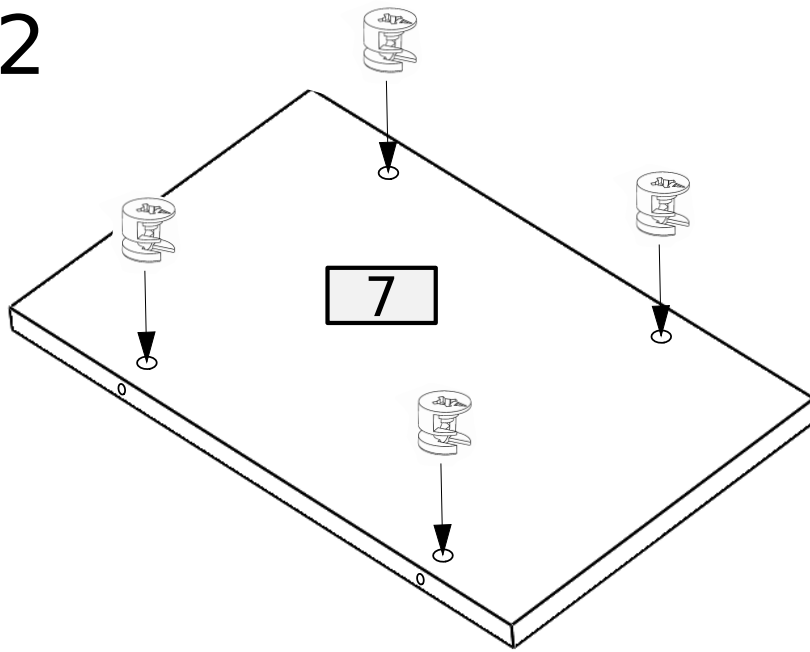



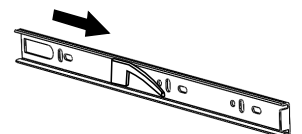
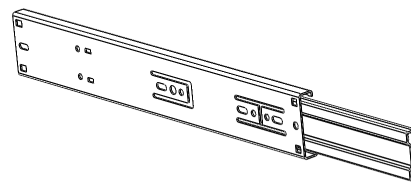
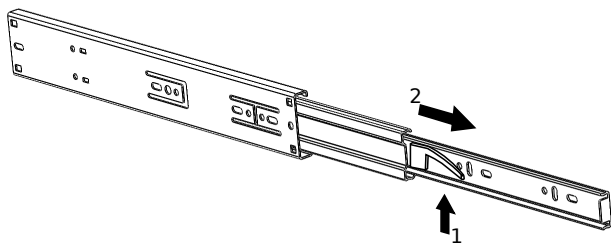
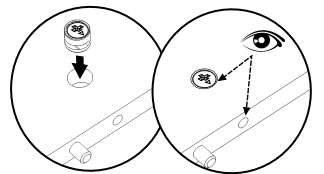
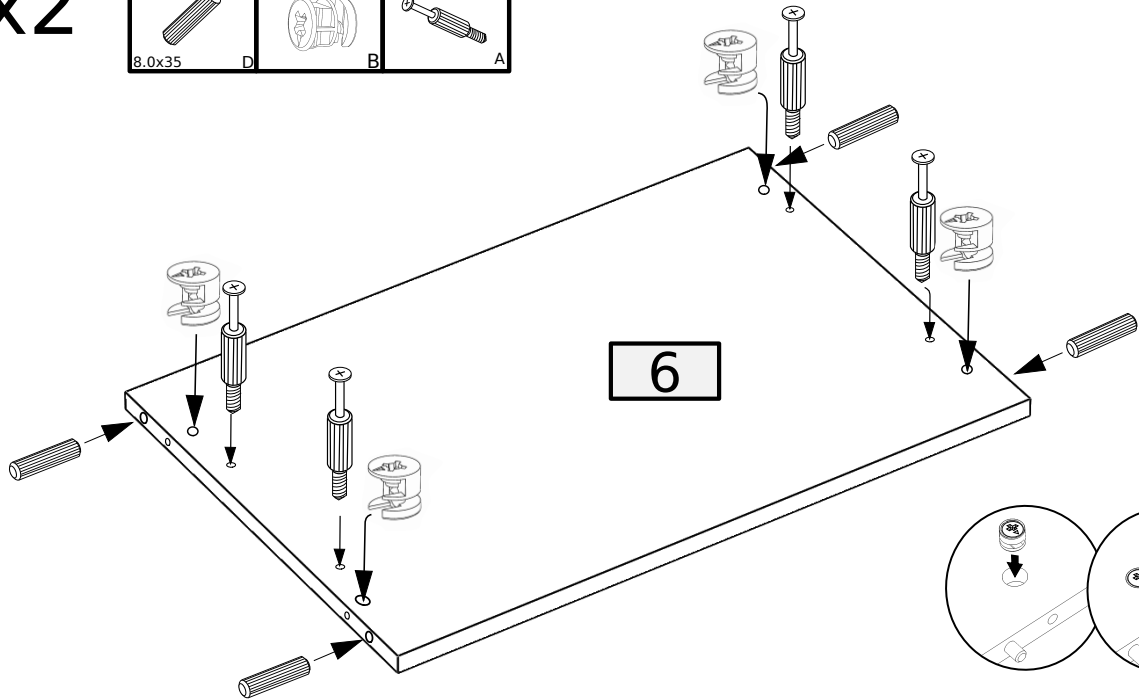
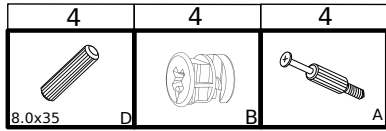

⑤ x2



x4



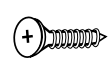

PK

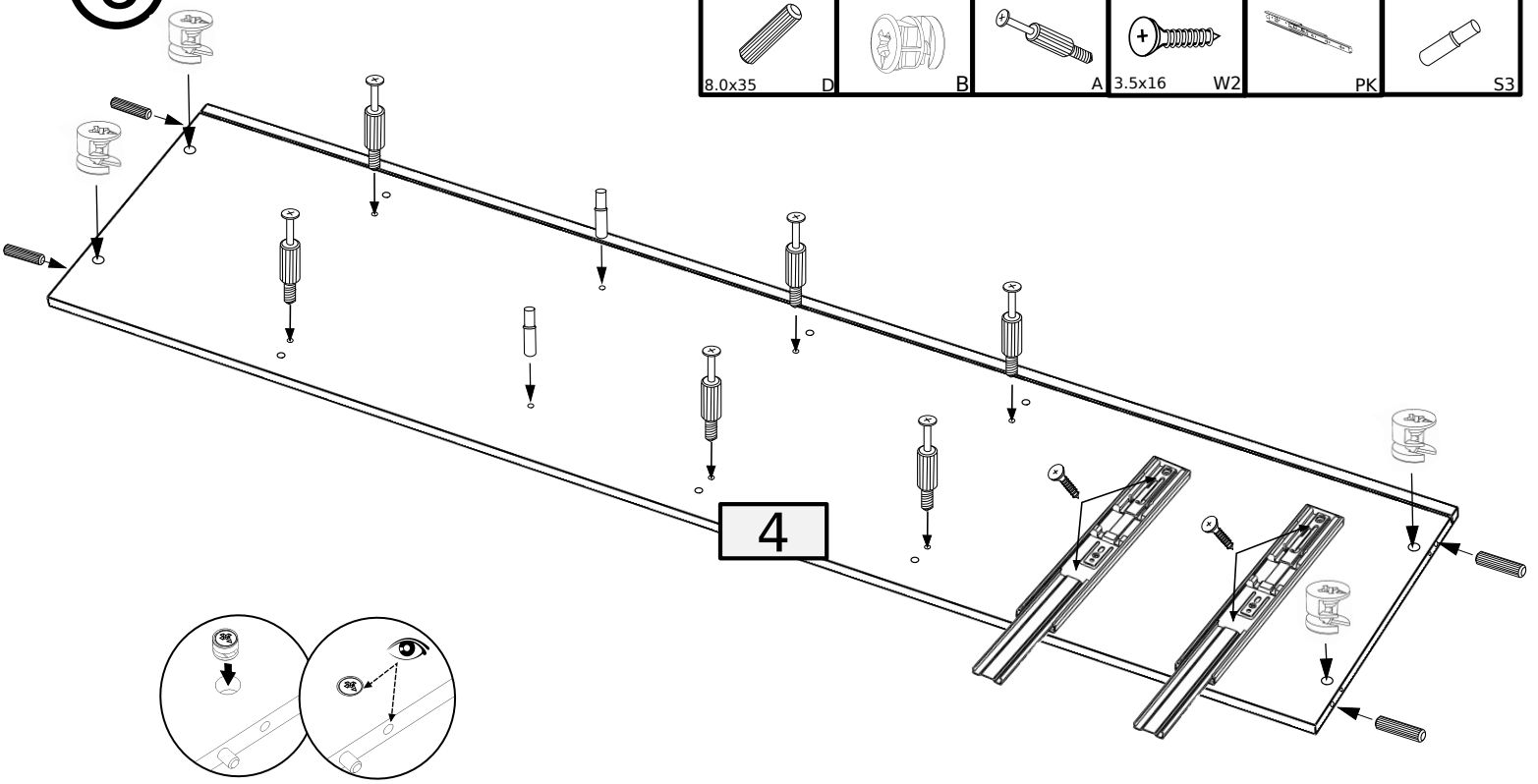
6

4	4	6	4	2	2
					
8.0x35	D	A	3.5x16	W2	PK

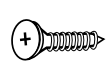

7

4	4	6	4	2	2
					
8.0x35	D	A	3.5x16	PK	S3

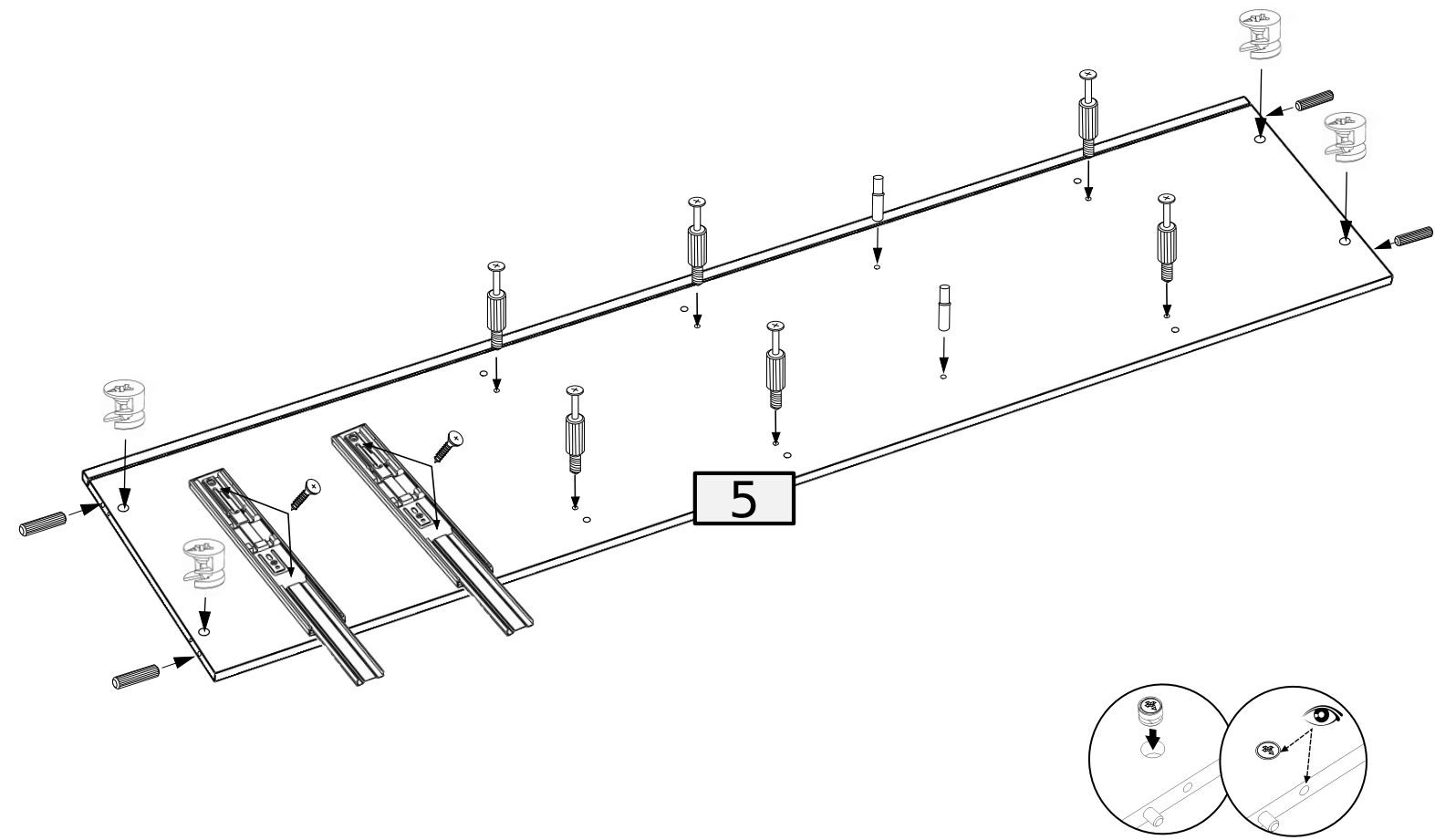

⑧ x2

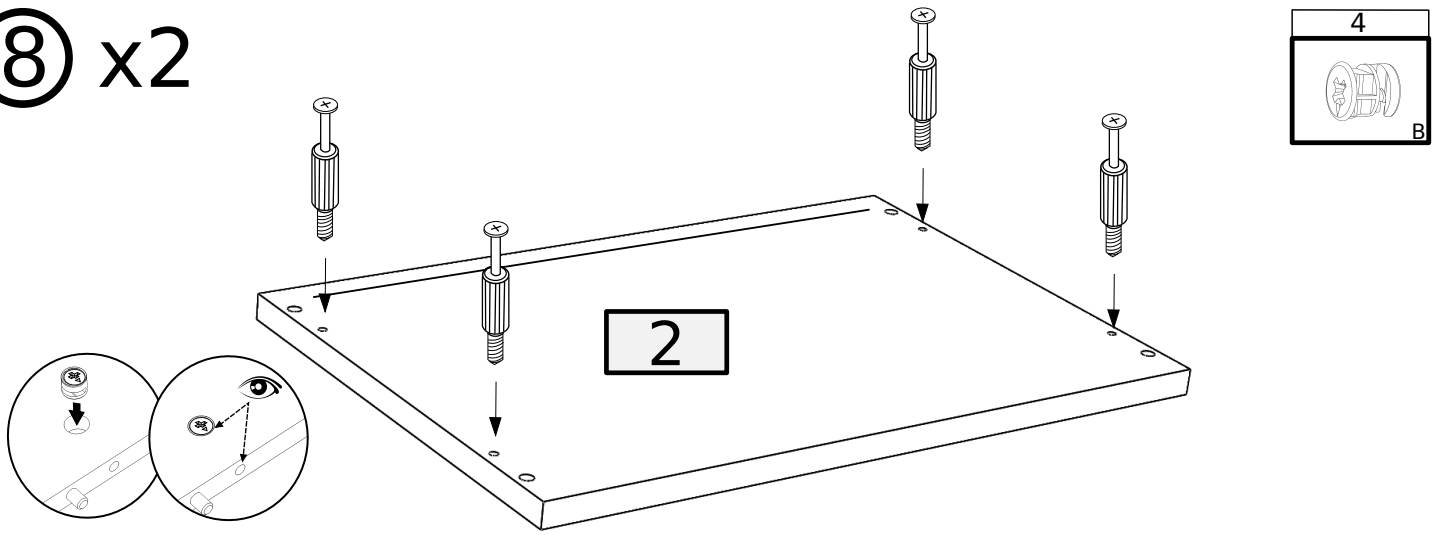

⑨

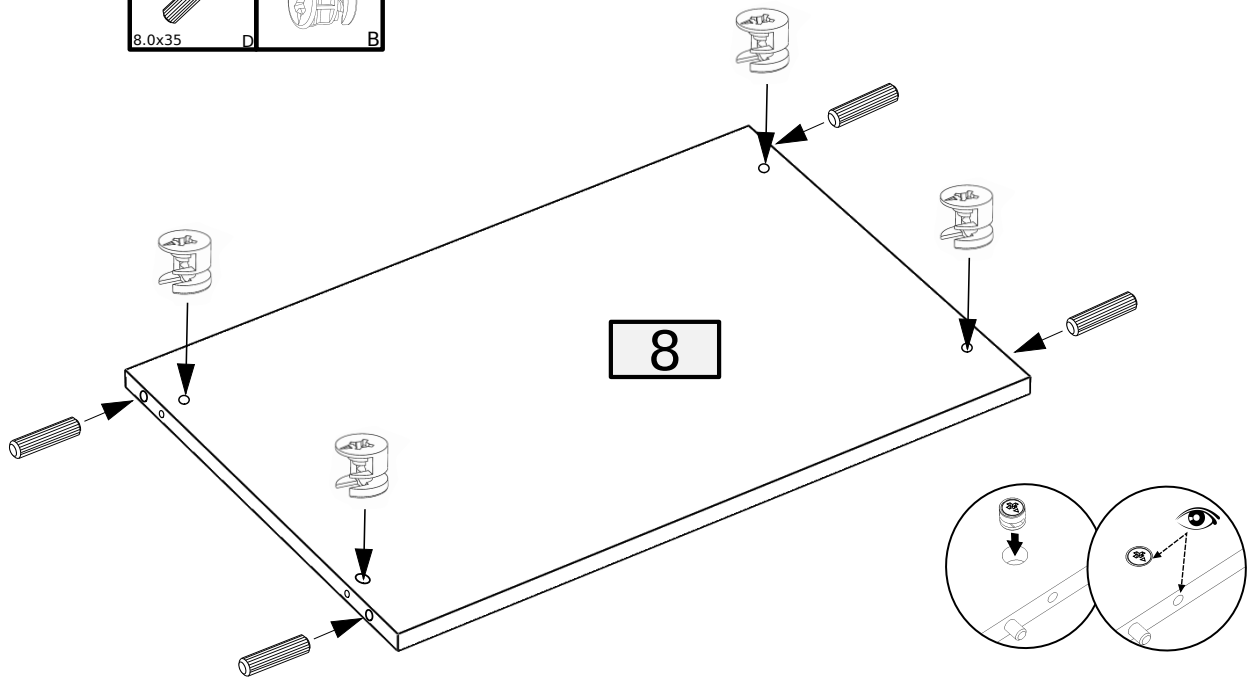
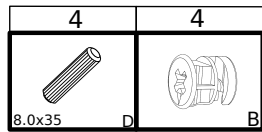

⑩

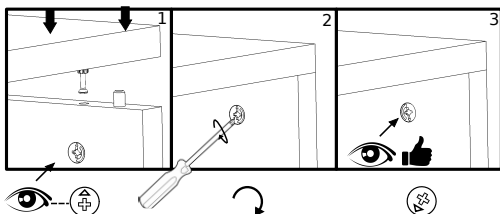
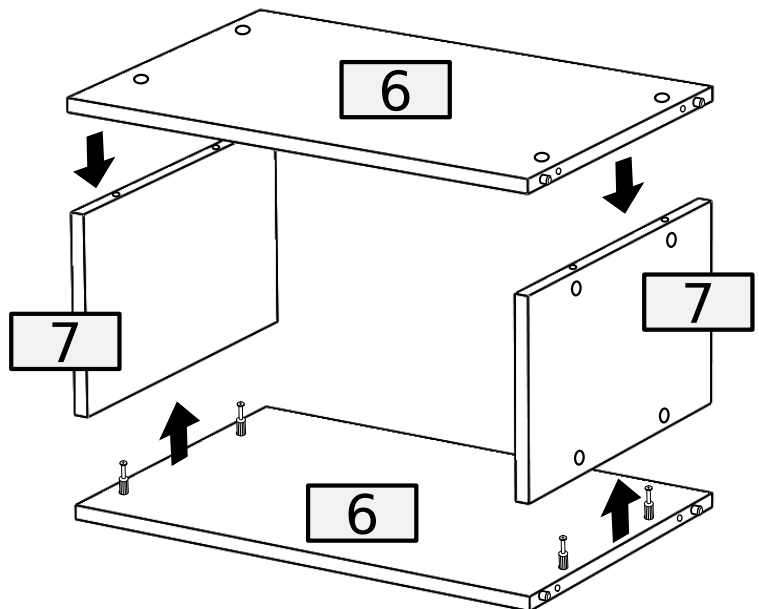

11

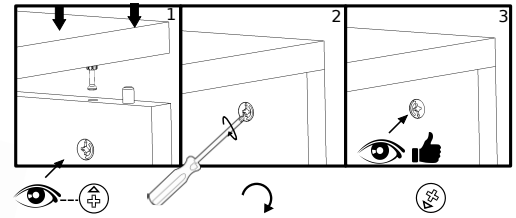
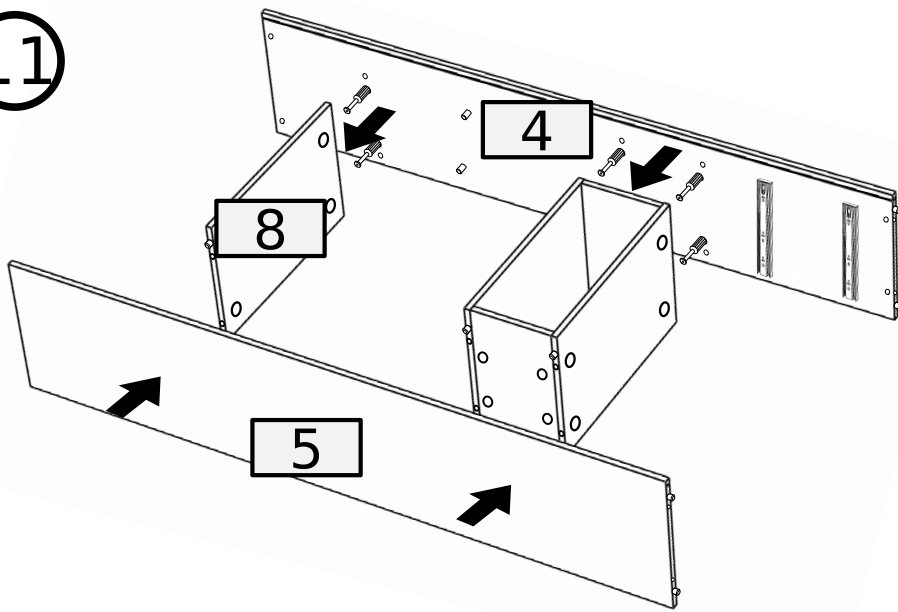

12

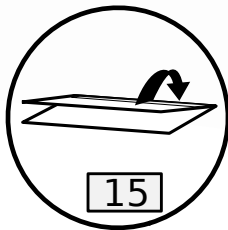
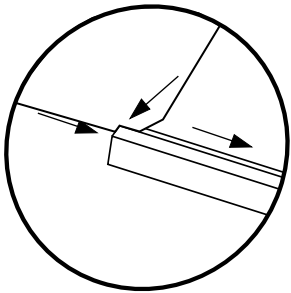
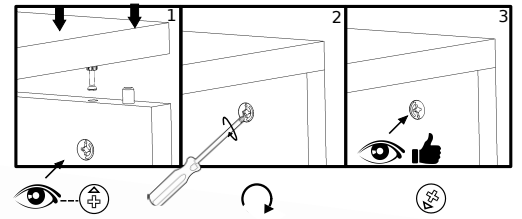
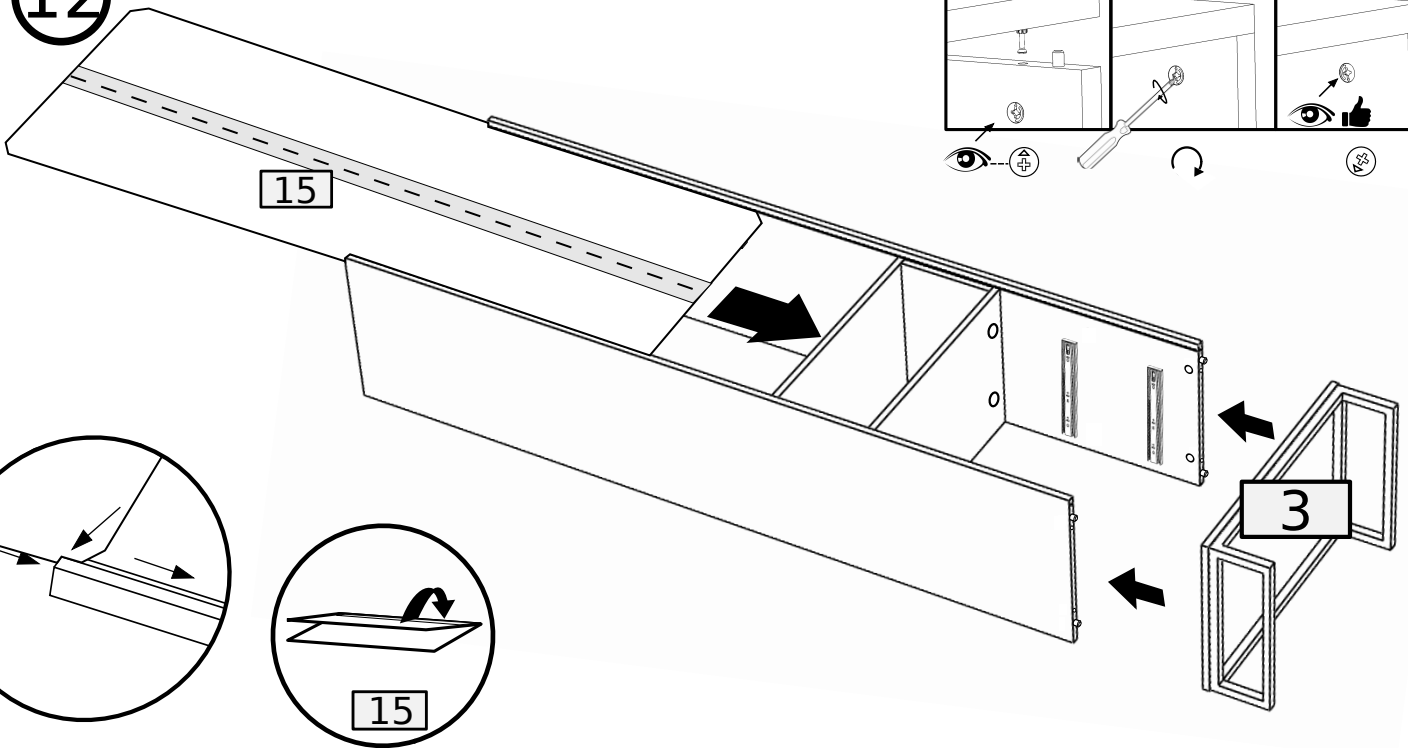

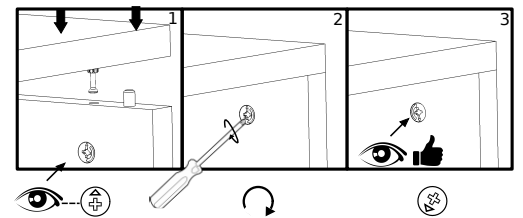
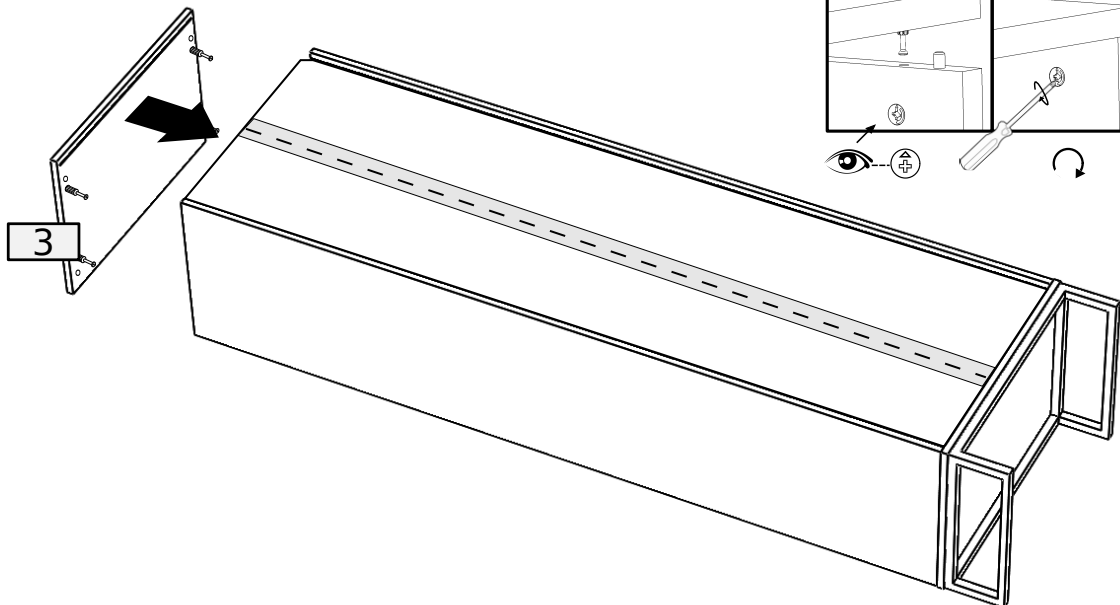

13



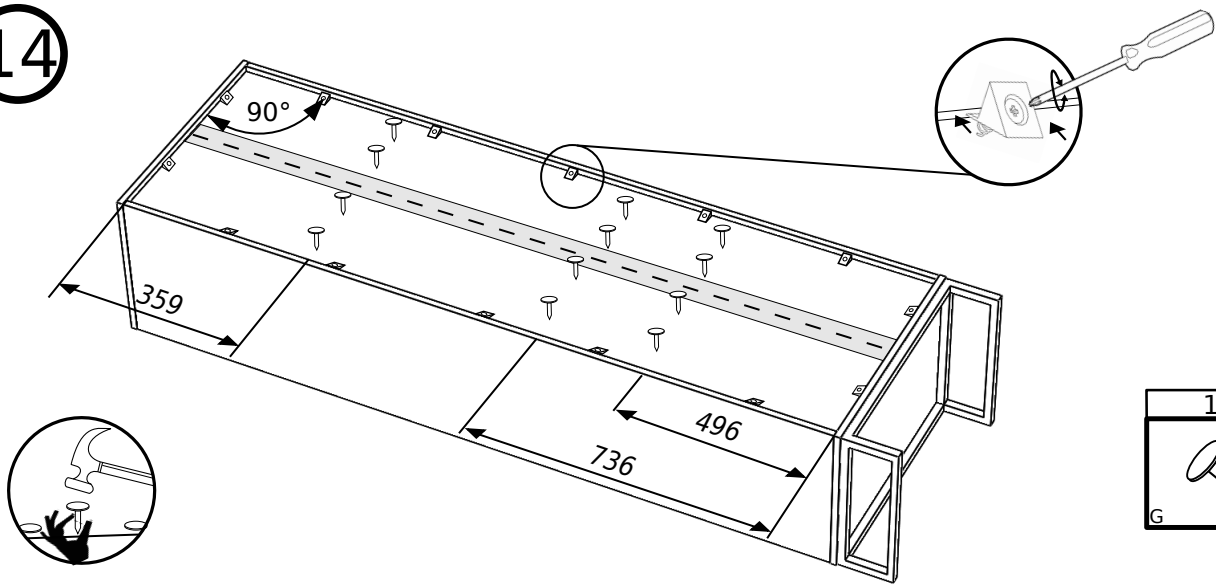

14



12	14
	
G	I

15

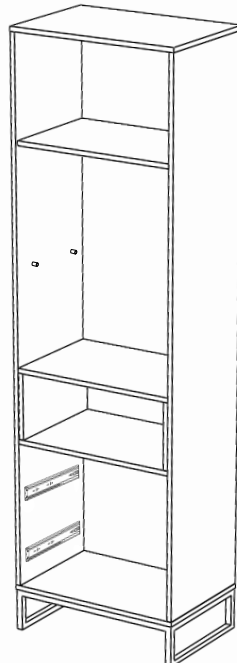
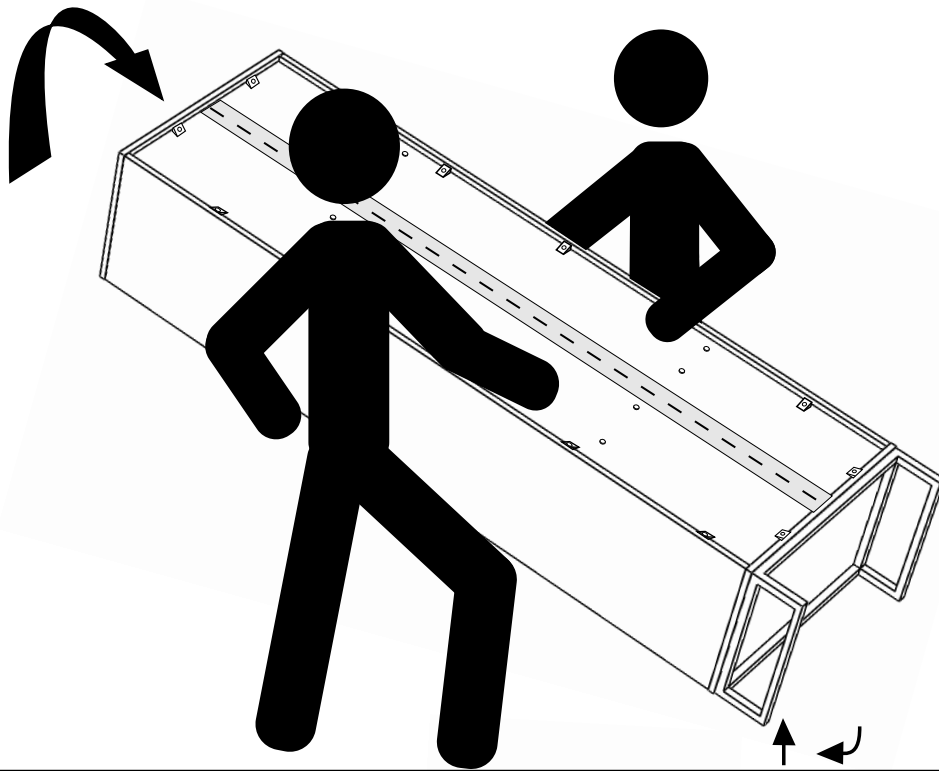

16 x2

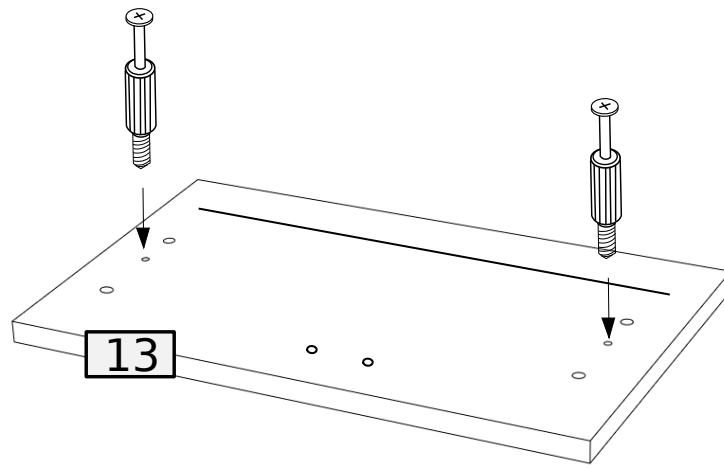
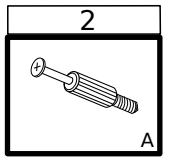

17 x2

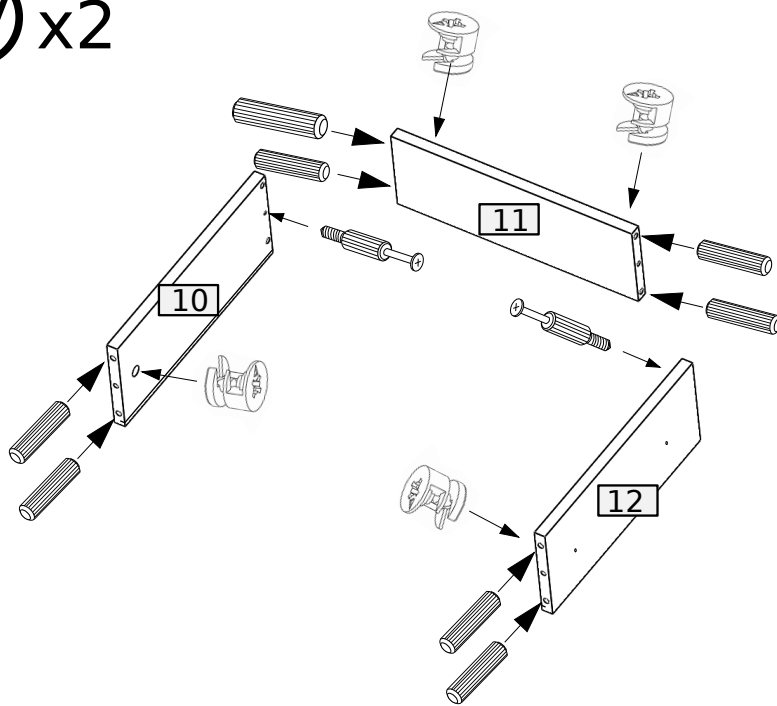
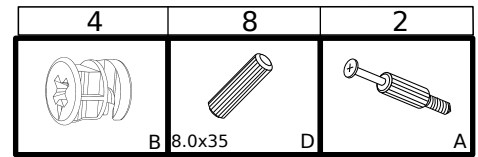

18 x2

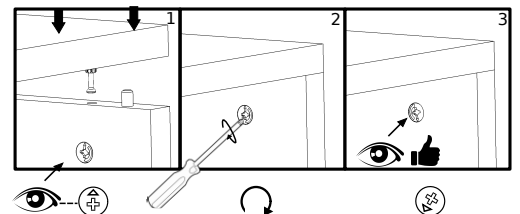
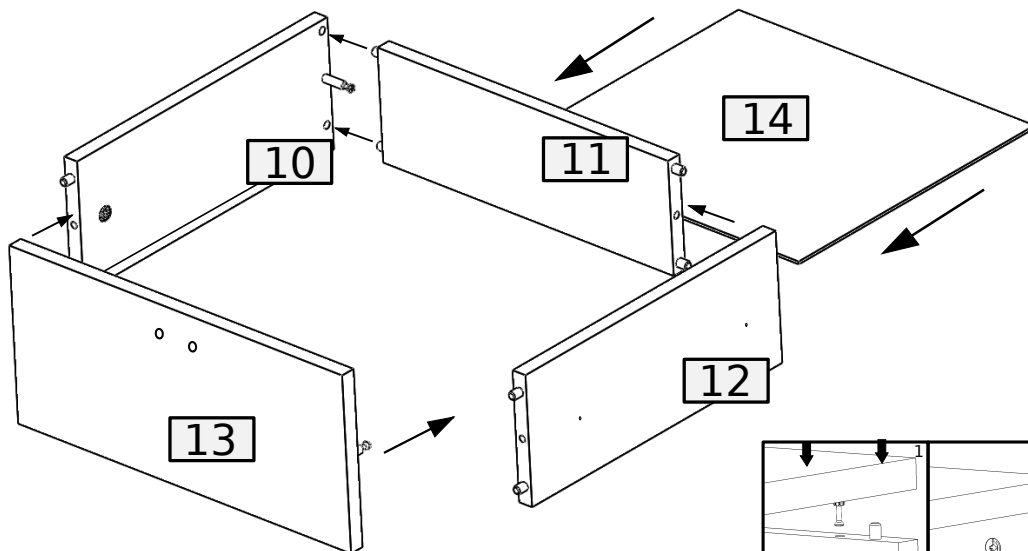

19 x2

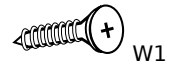
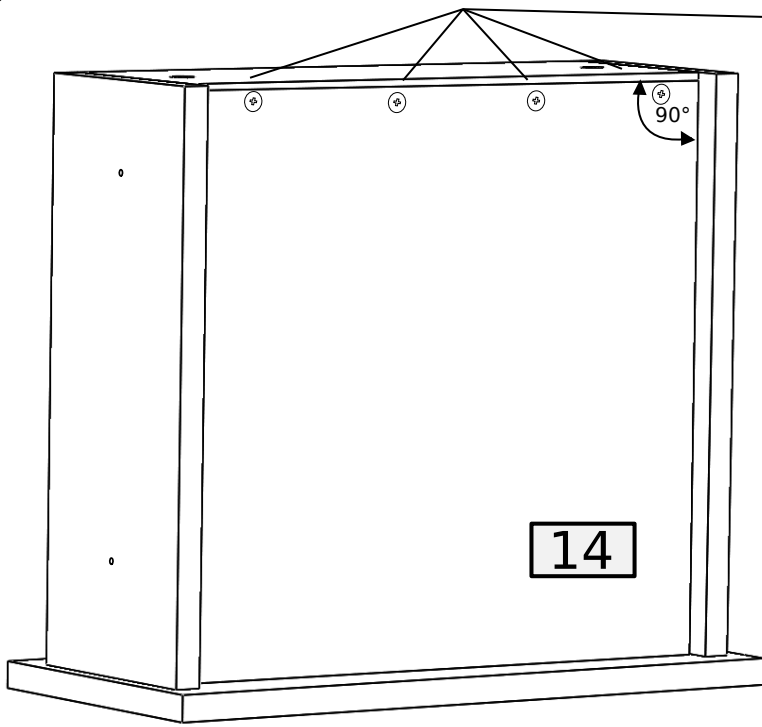

4	
3.0x20	W1

20 x2

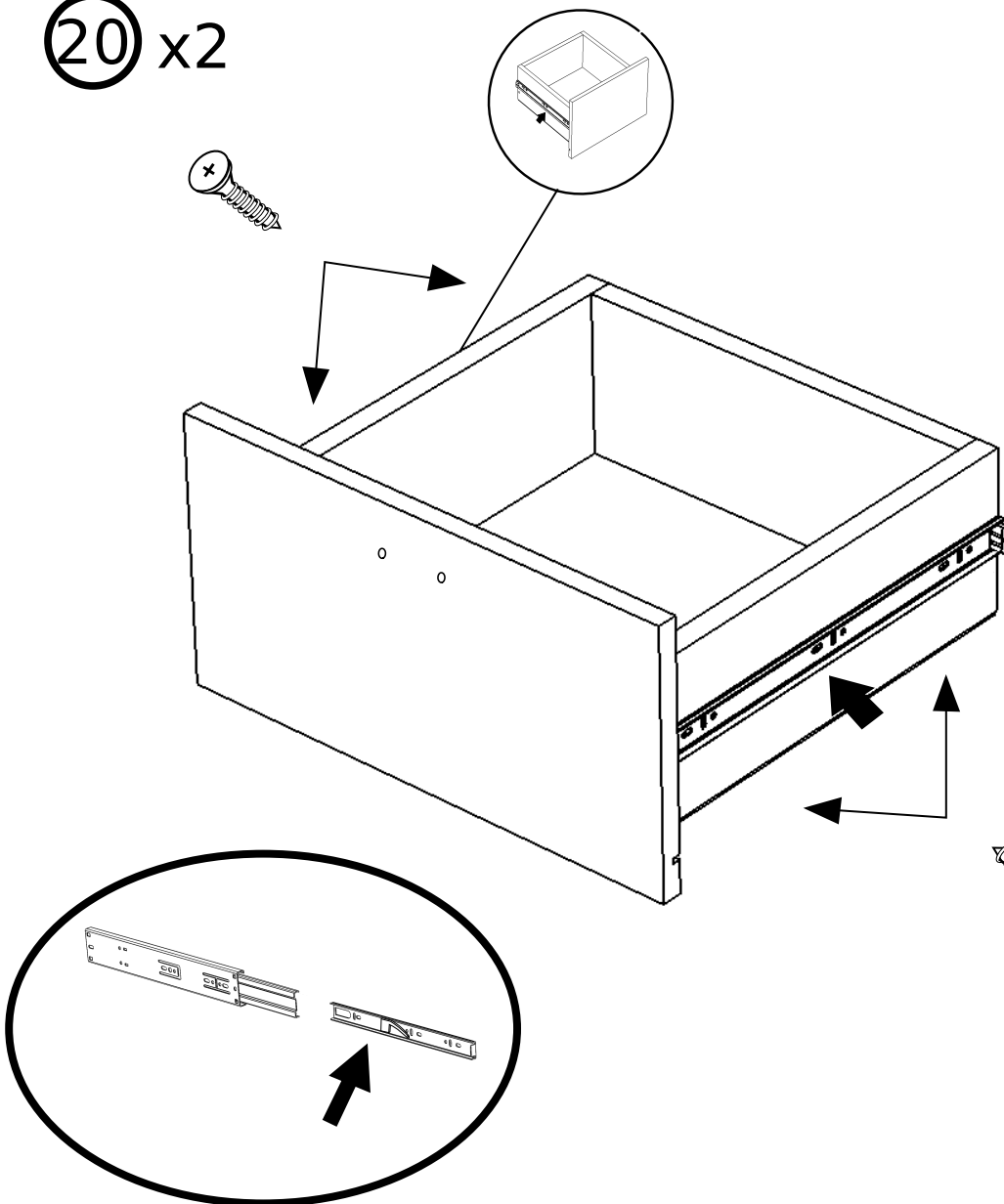

2	4
PK 3.5x16	W2

26

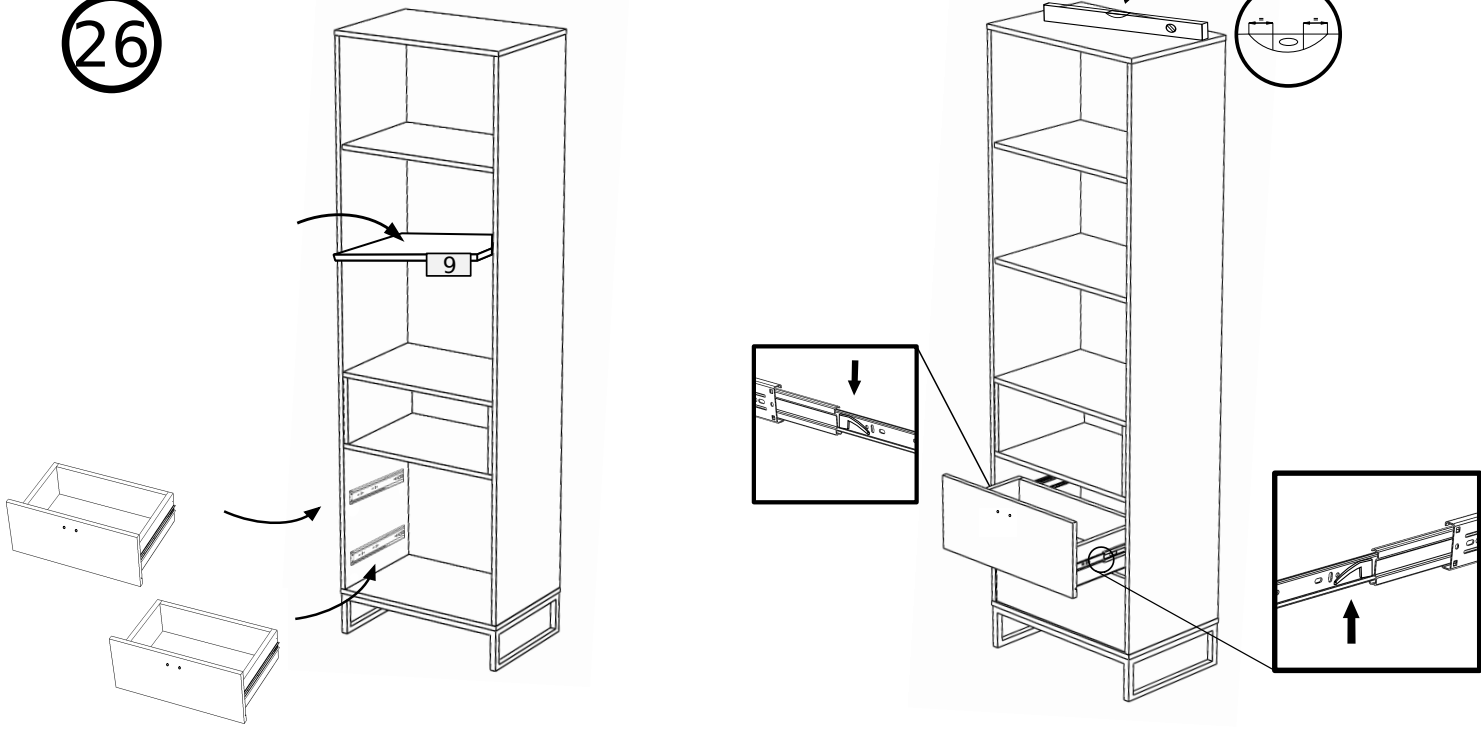

2	4
UO	3.5x25 W10

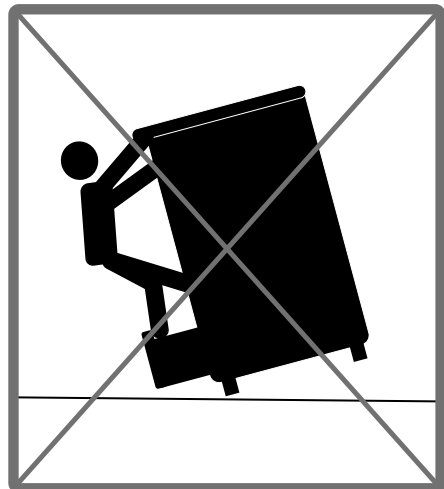
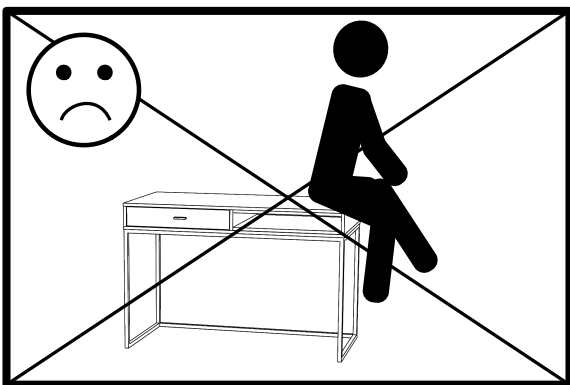
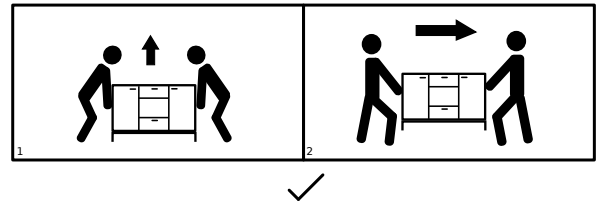
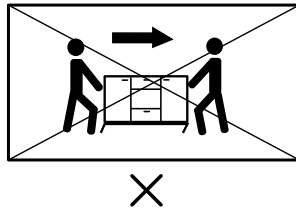
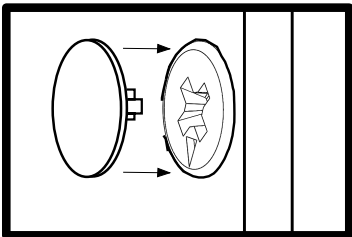
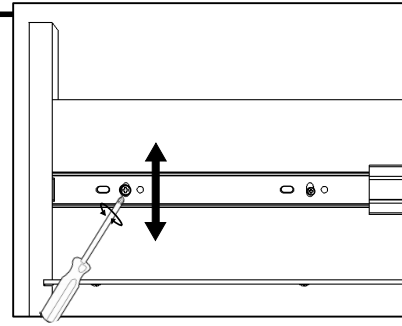
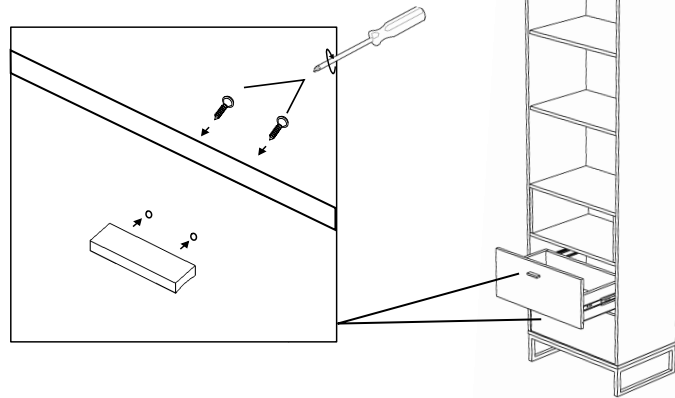

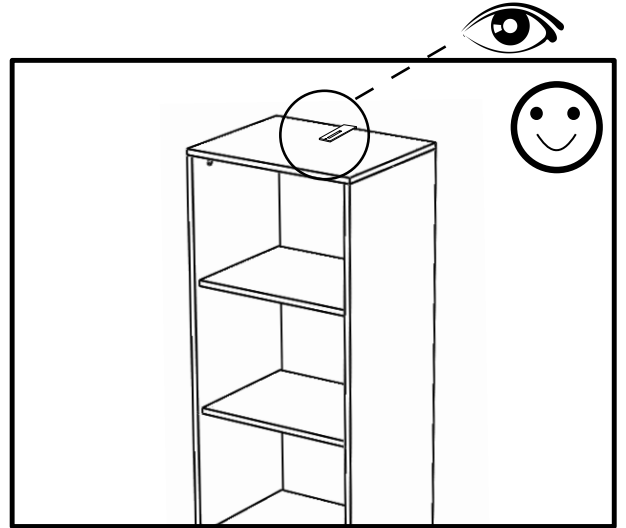
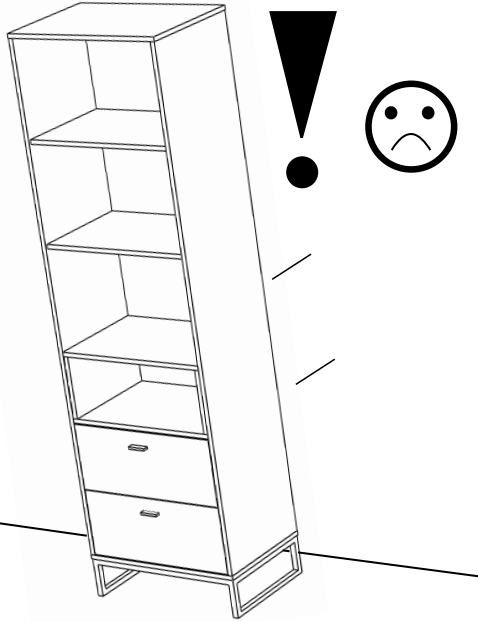

1

ø5.00 mm

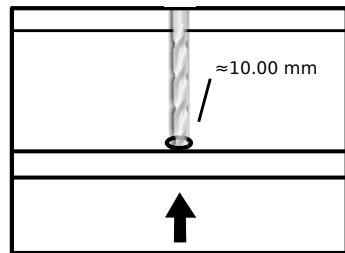
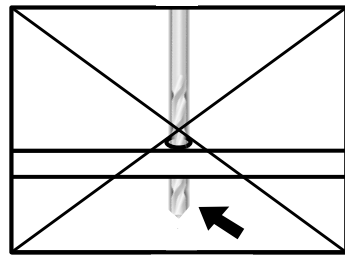
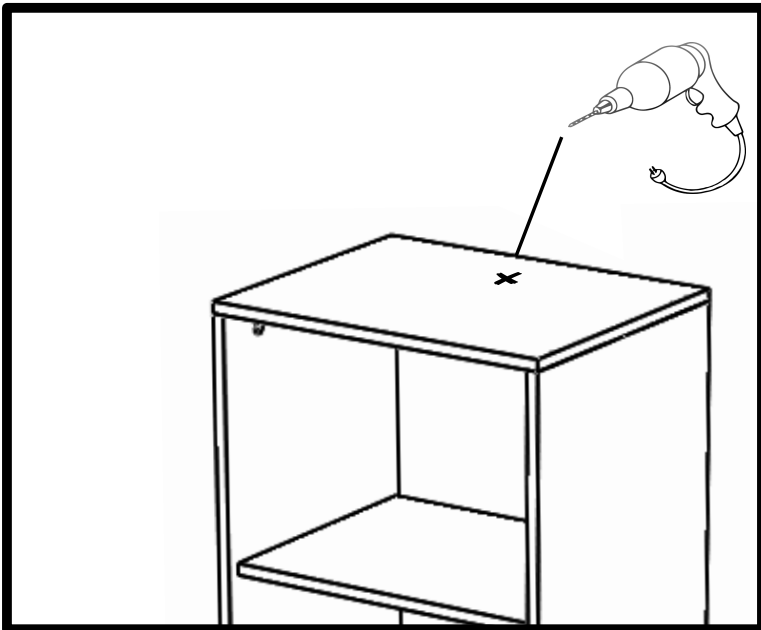

2

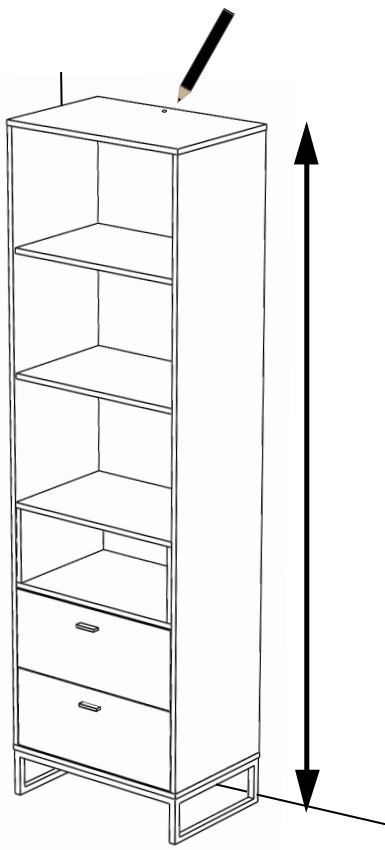

3

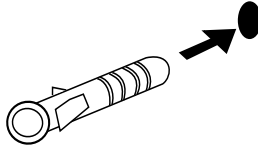

4

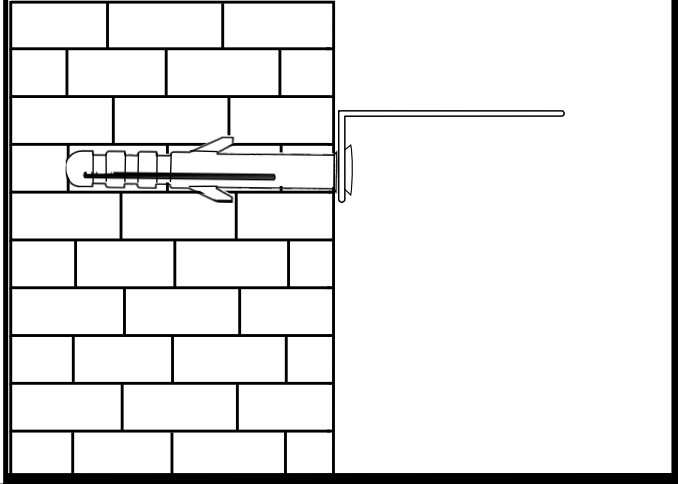
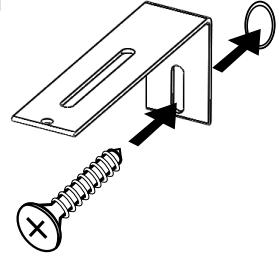

5

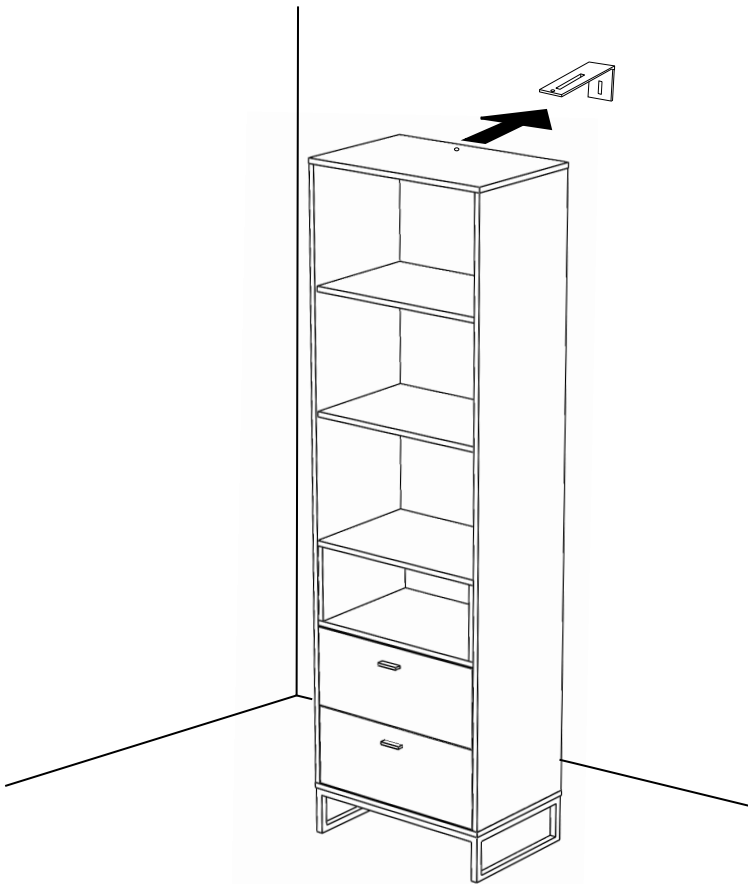

6

