

$\dagger 10 \times 50 \text{mm}$	$\dagger 5.0 \times 70 \text{mm}$	$\dagger 20$
O7	P29	E1

1	1	1
---	---	---

$\dagger 8 \times 30 \text{mm}$	$6.4 \times 50 \text{mm}$	$\dagger 5 / \dagger 8 \text{mm}$	L=20mm		$60 \times 40 \times 20$	$\dagger 4.0 \times 25 \text{mm}$	
A	B	C6	D2	E	F1	P14	O
20	12	10	10	10	4	8	1

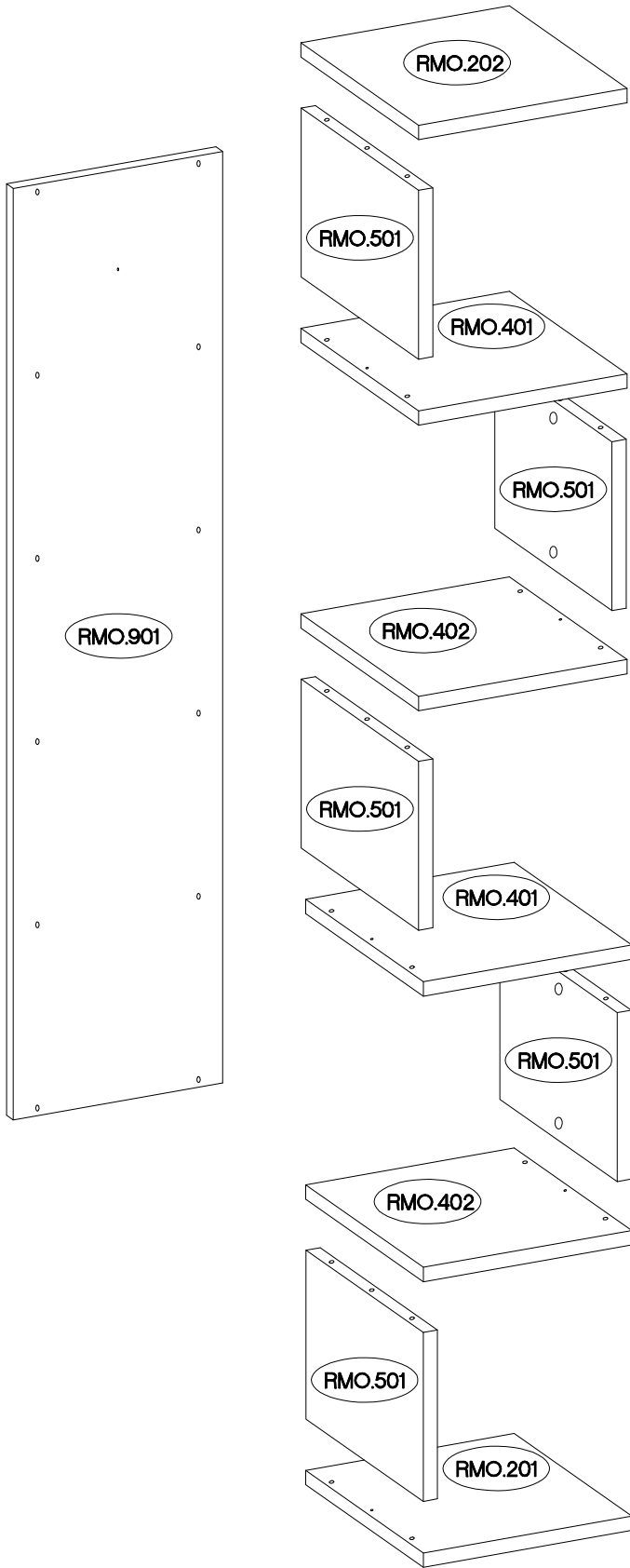

- RMO.201
- RMO.202
- RMO.401
- RMO.402

	RMO.201	414x281x28
	RMO.202	414x281x28
	RMO.401 x 2	414x281x28
	RMO.402 x 2	414x281x28
	RMO.501 x 5	330x280x28
1/1	RMO.901	1820x416x16

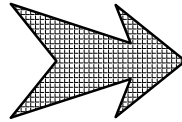
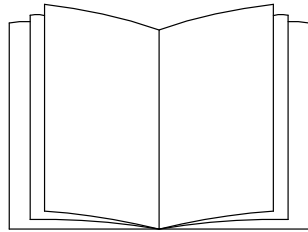
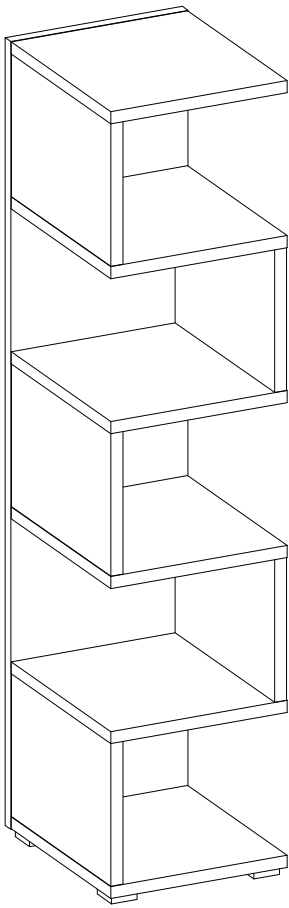

1 — 17

35

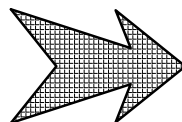
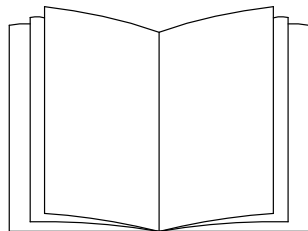
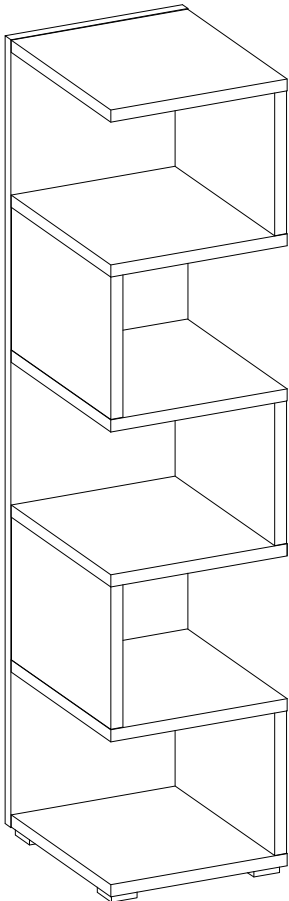



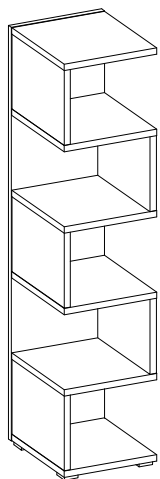

18 — 34

35

1

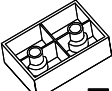

ø8x30mm	ø15/18mm	L=20mm	60x40x20	ø4.0x25mm
				
A	C6	D2	F1	P14
20	10	10	4	8

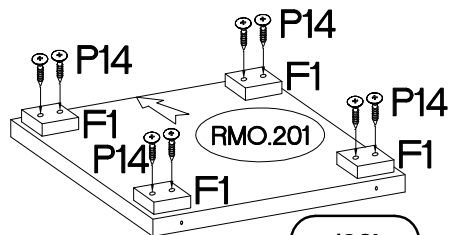
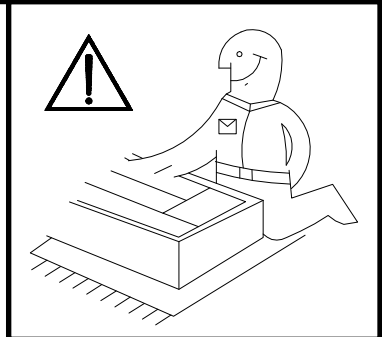

x1

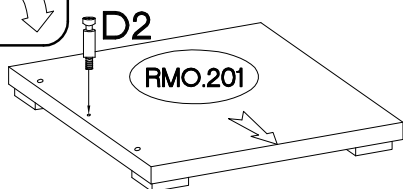
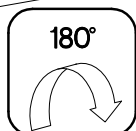

x1

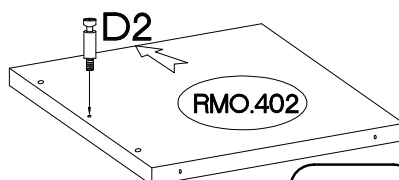
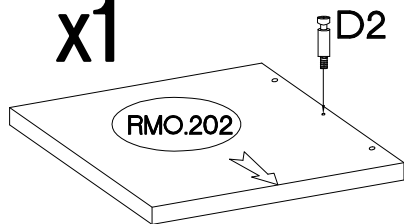

x2

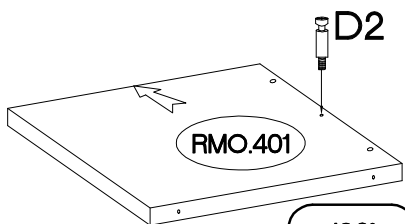
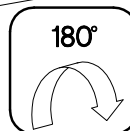

x2

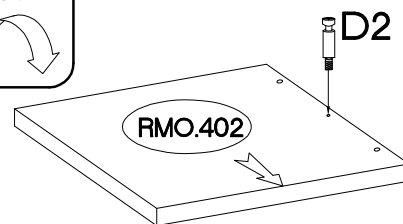
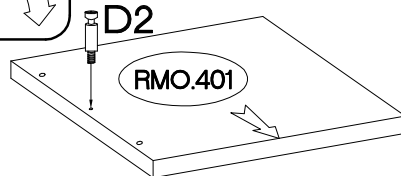
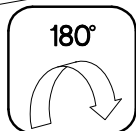

x5

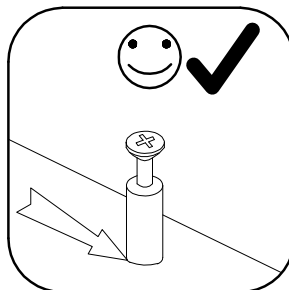
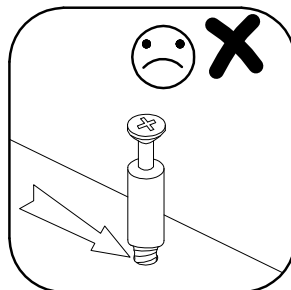
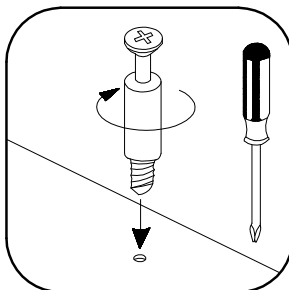
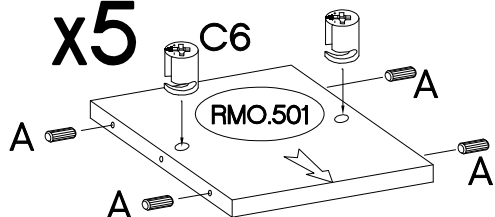

2

6,4 x 50mm

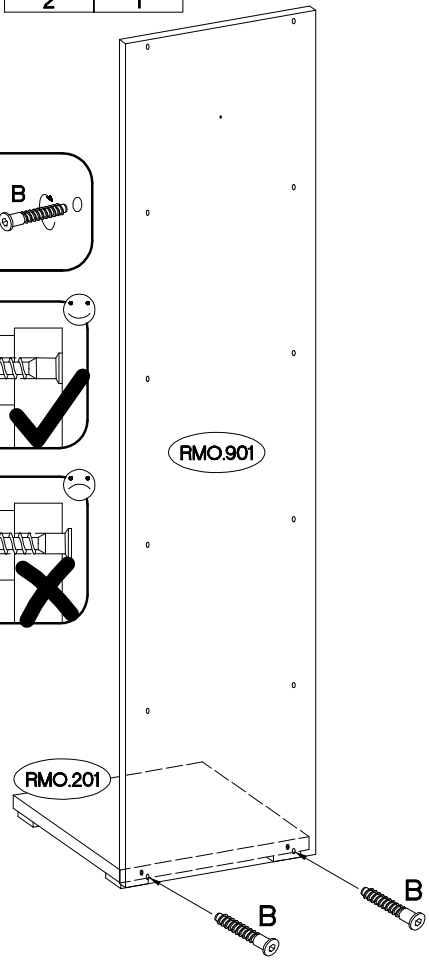
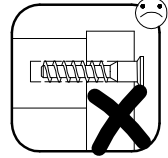
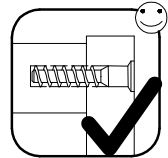
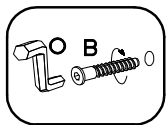
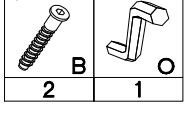

3

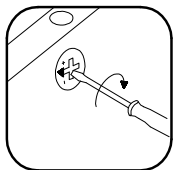
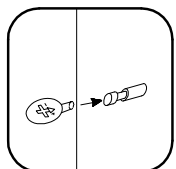
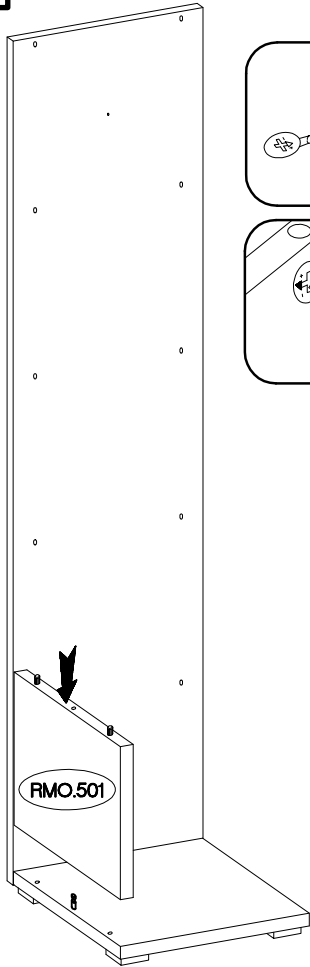

4

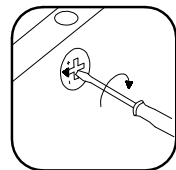
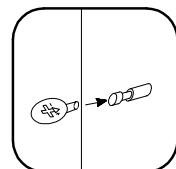
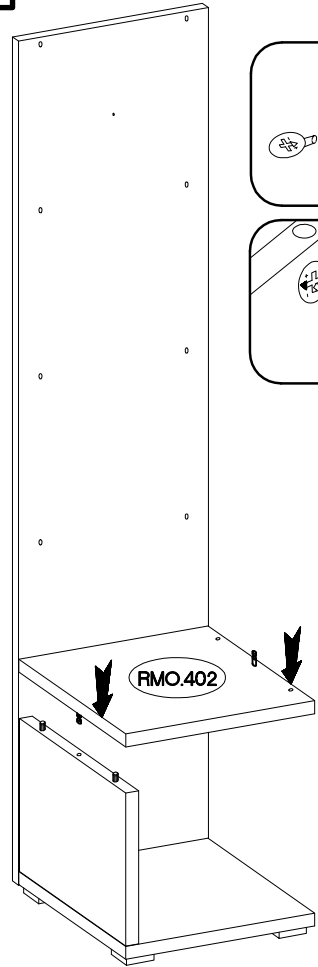

5

6,4 x 50mm

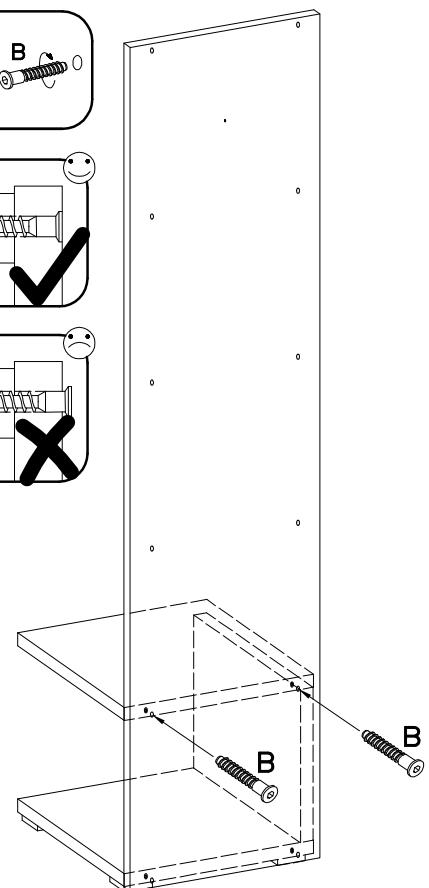
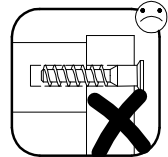
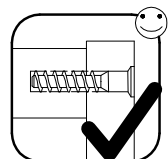
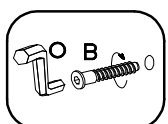
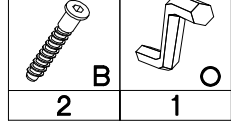

6

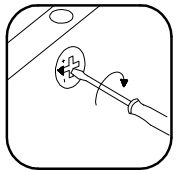
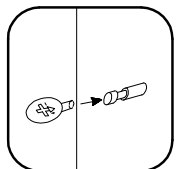
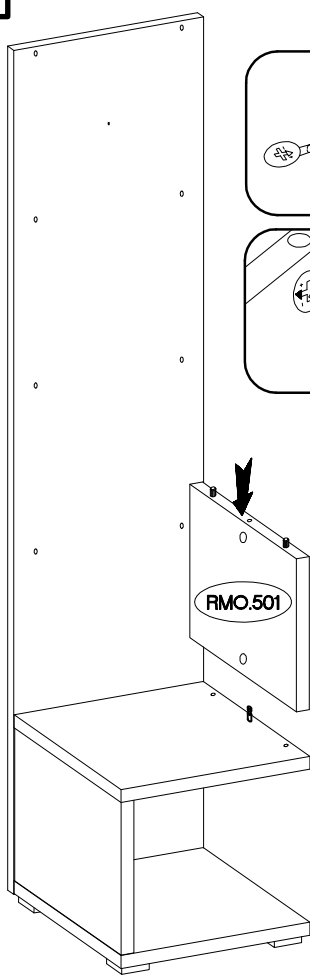

7

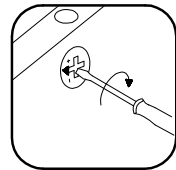
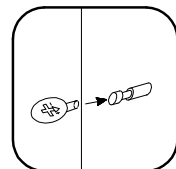
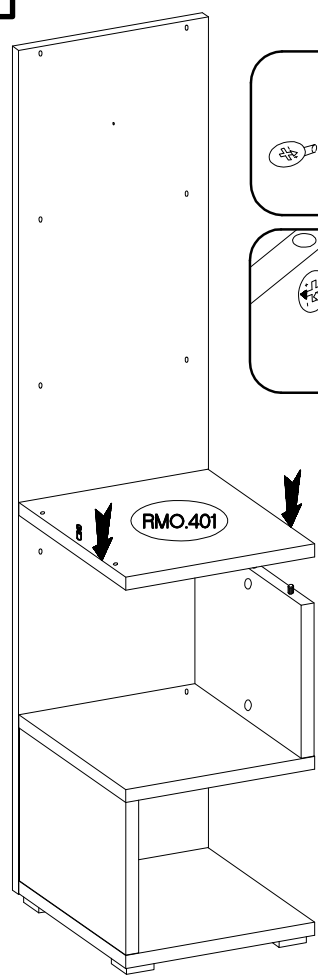

8

6,4 x 50mm



B



O

2

1

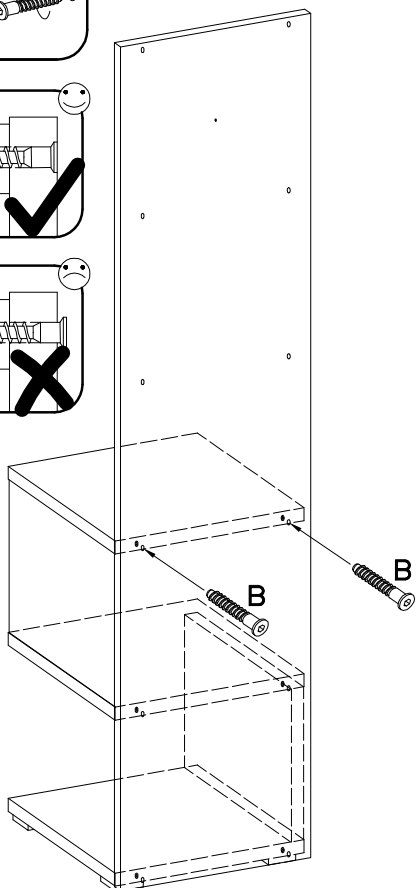
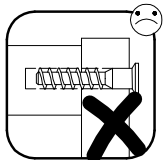
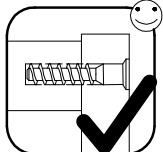
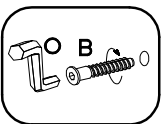

9

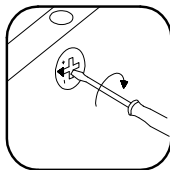
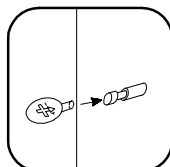
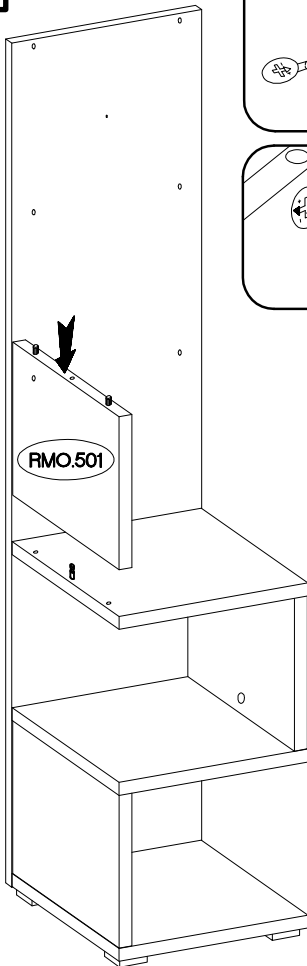

10

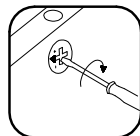
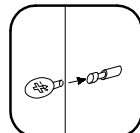
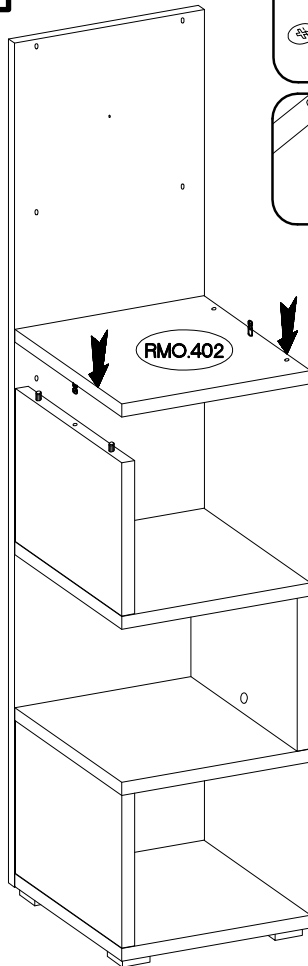

11

6,4 x 50mm



B



O

2

1

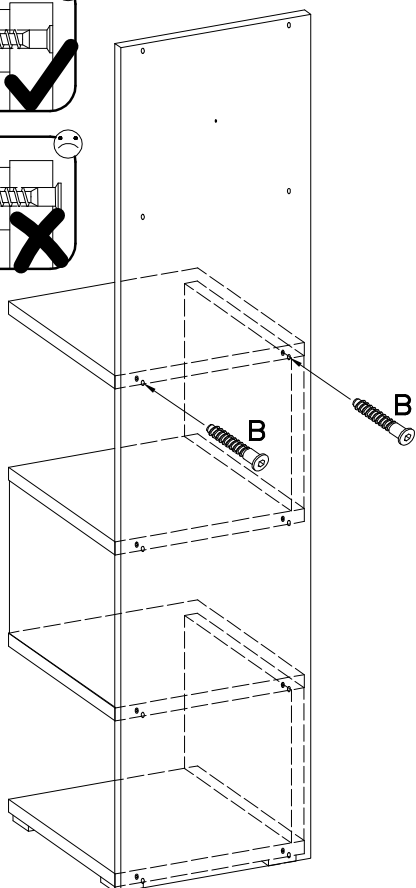
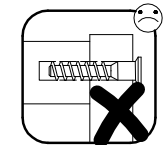
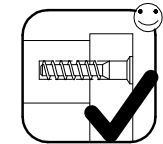

12

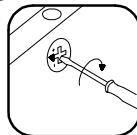
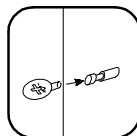
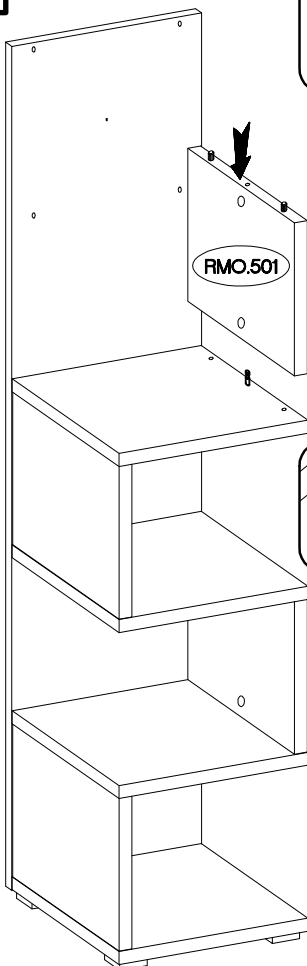

13

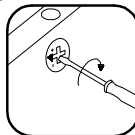
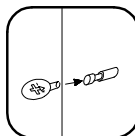
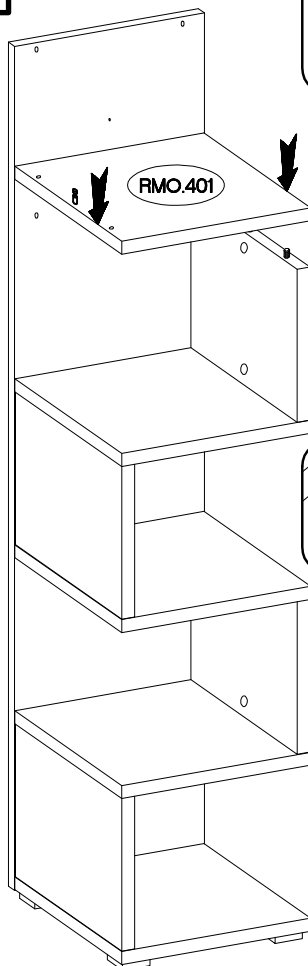

14

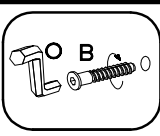

6,4 x 50mm

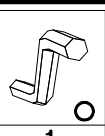
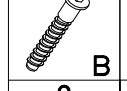

2

1

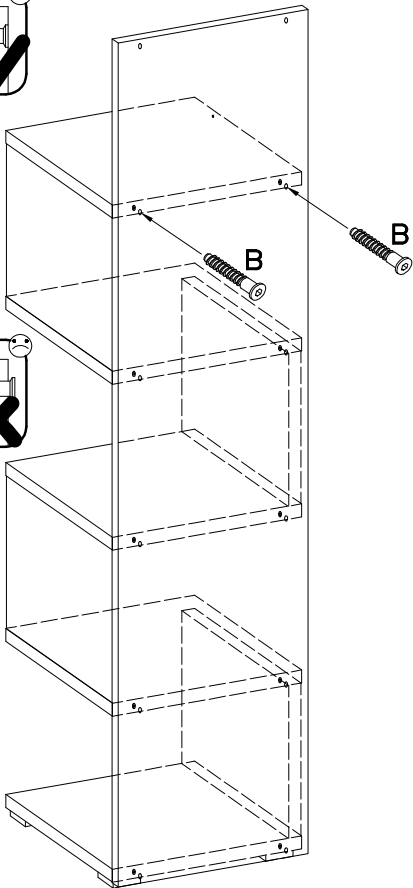
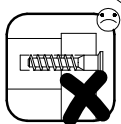

15

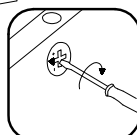
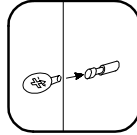
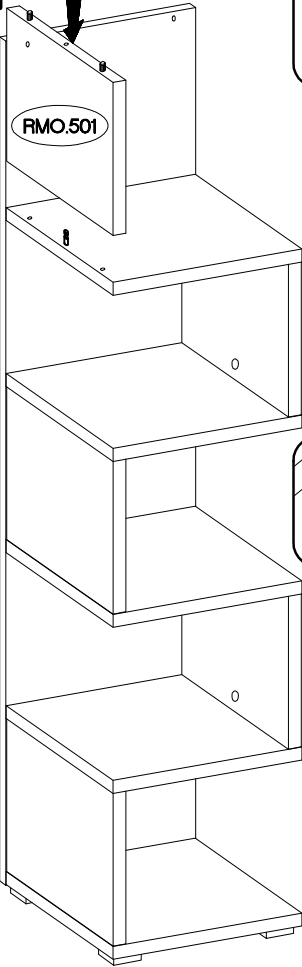

16

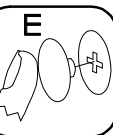
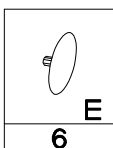
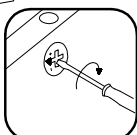
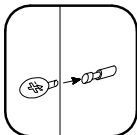
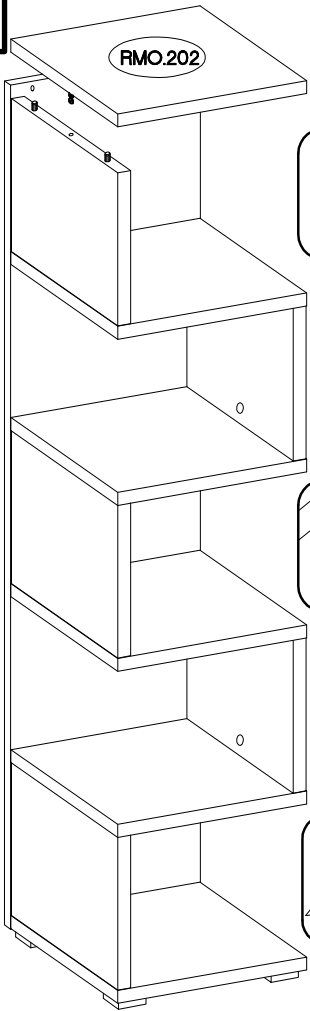

17

6,4 x 50mm

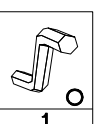
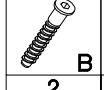



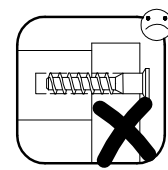
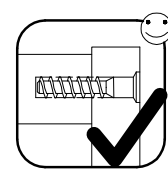
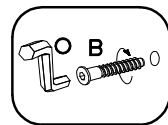
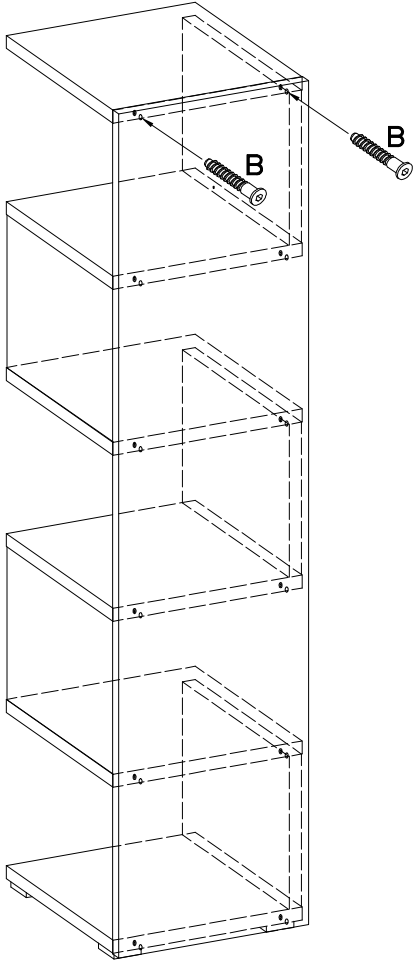

2

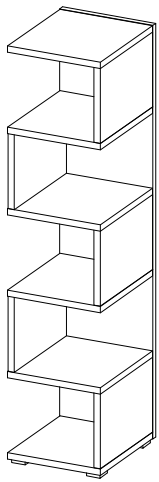
1



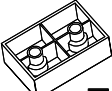

ø8x30mm	ø15/18mm	L=20mm	60x40x20	ø4.0x25mm
				
A	C6	D2	F1	P14
20	10	10	4	8

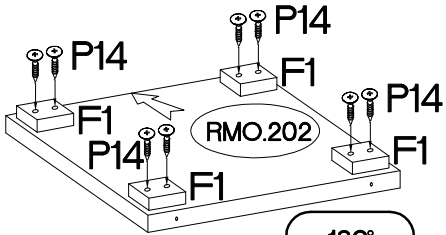
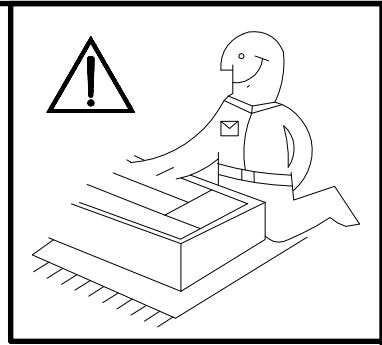

x1

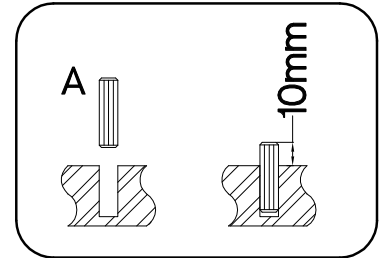
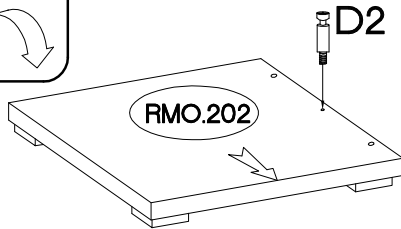
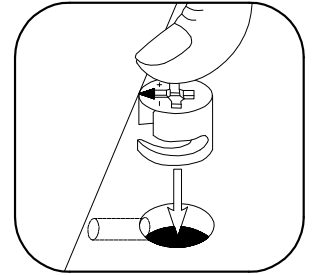
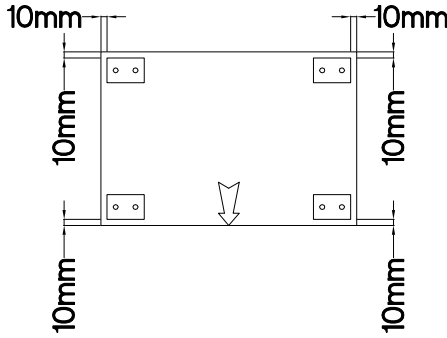
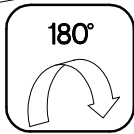

x1

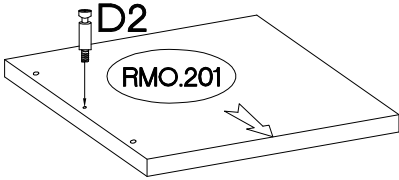

x2

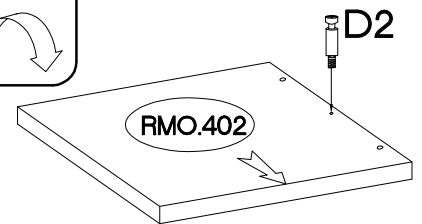
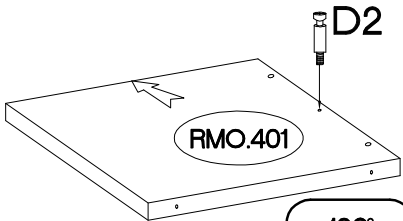
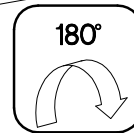

x2

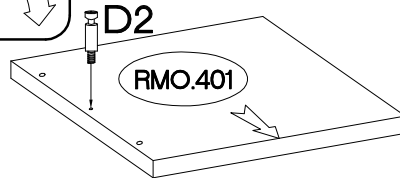
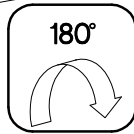

x5

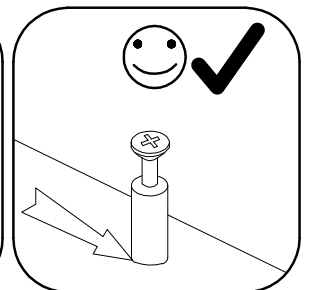
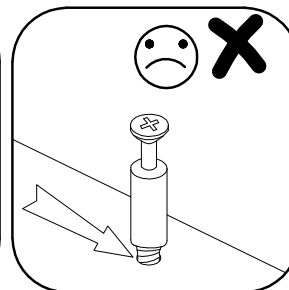
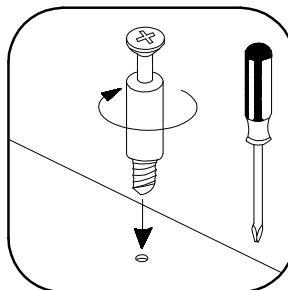
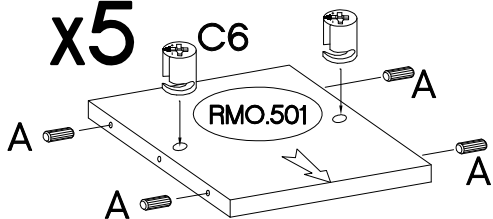

19

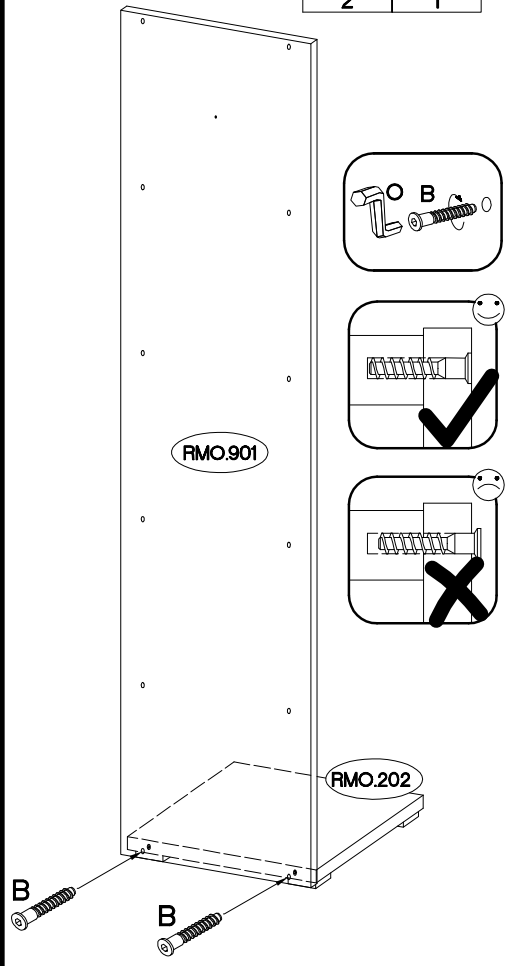
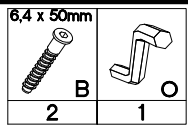

20

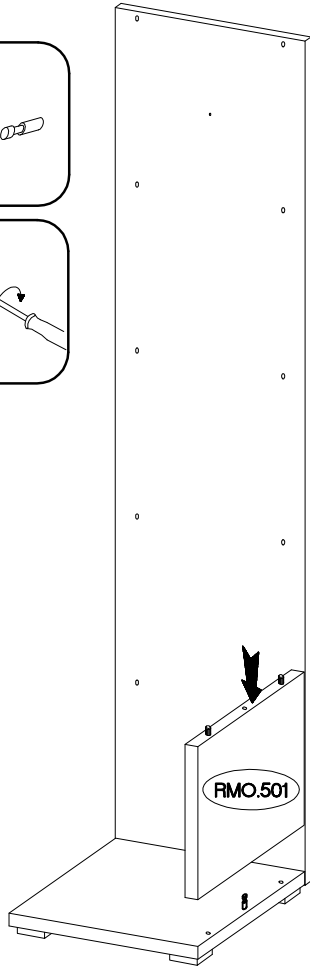
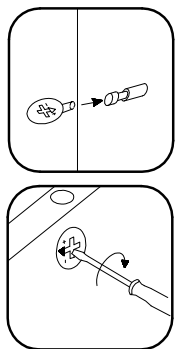

21

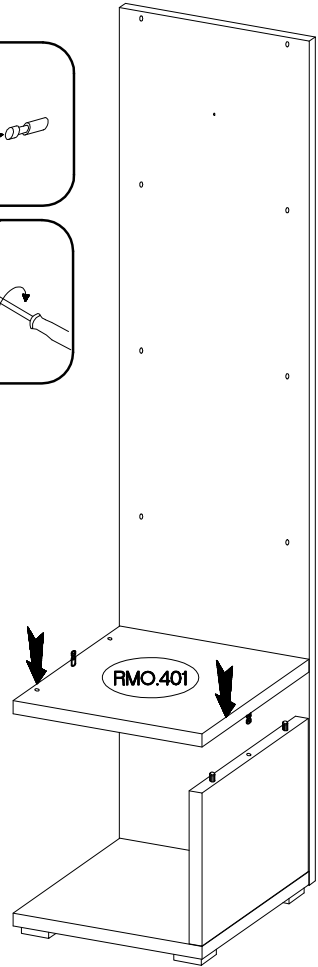
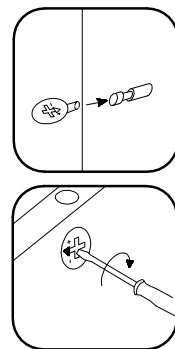

22

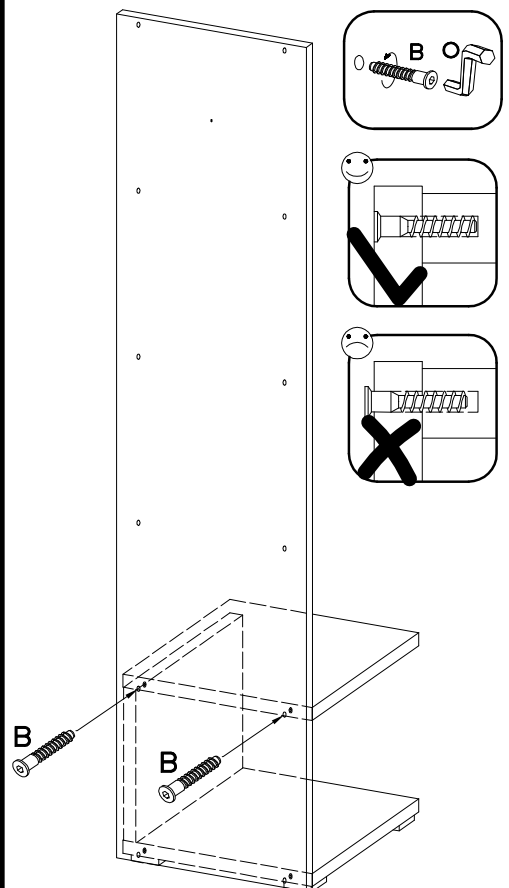
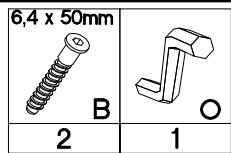

23

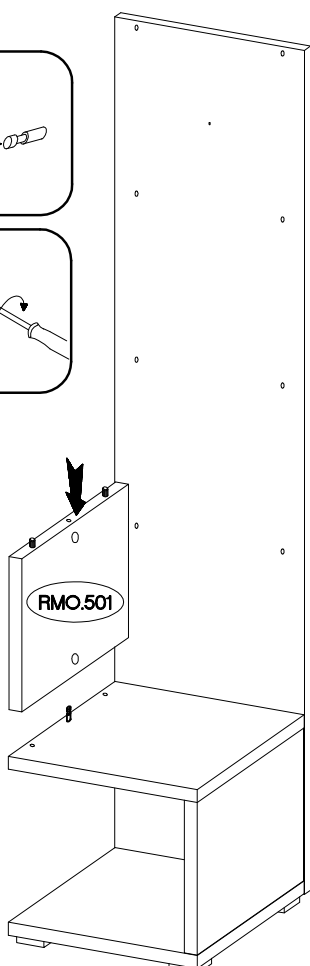
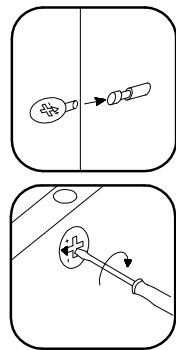

24

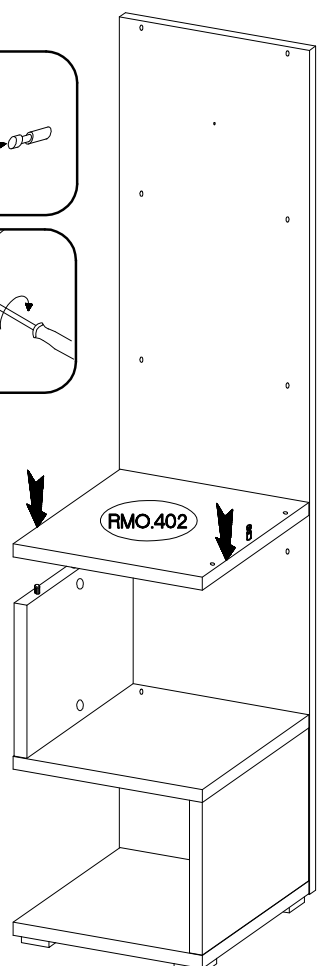
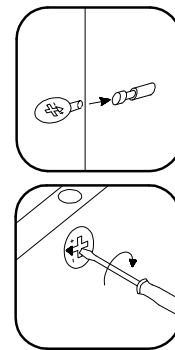

25

6,4 x 50mm



B

O

2

1

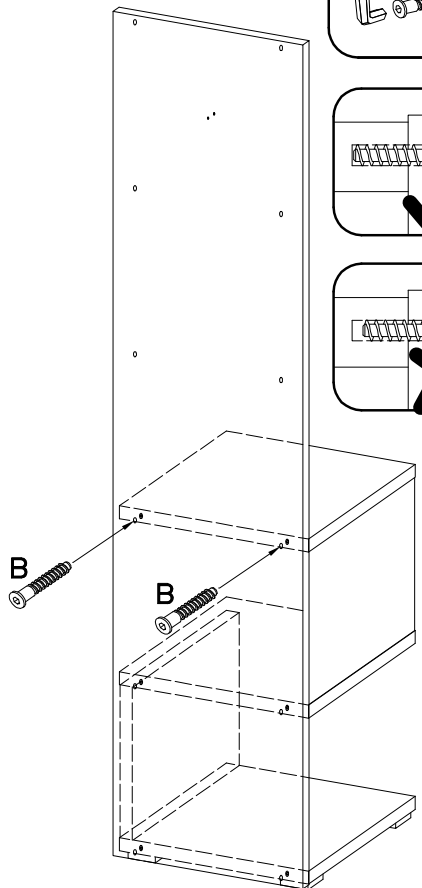
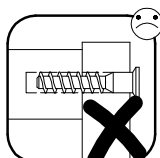
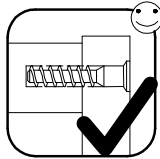
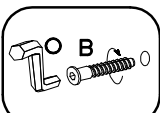

26

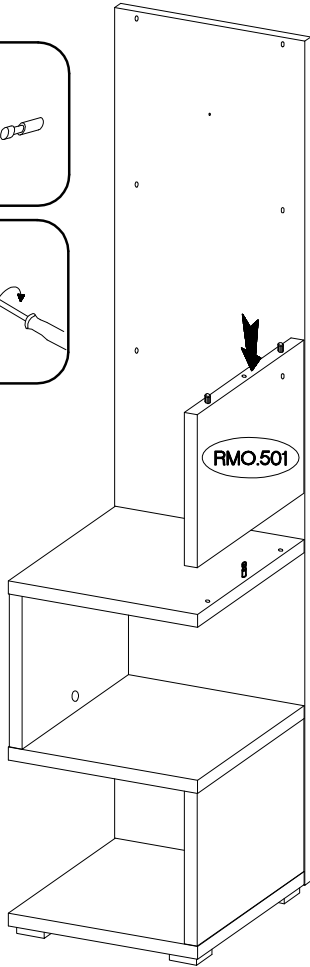
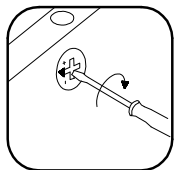
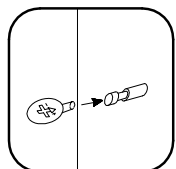

27

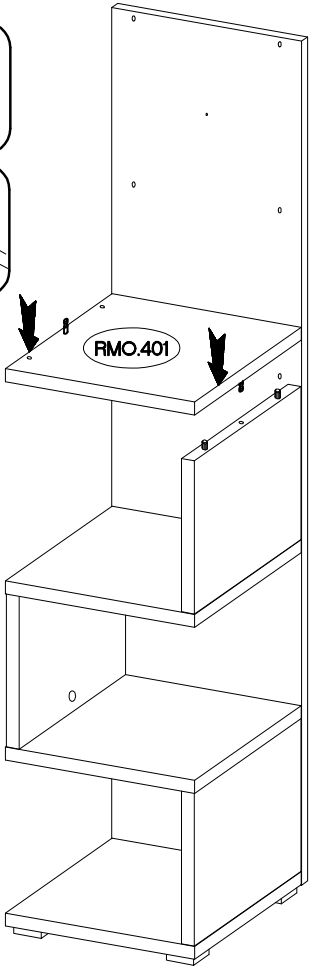
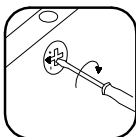
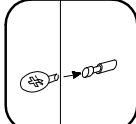

28

6,4 x 50mm



B

O

2

1

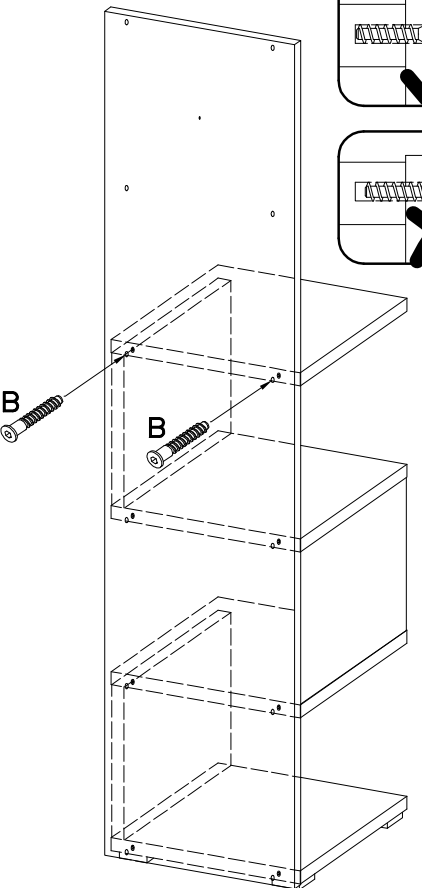
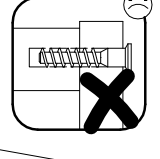
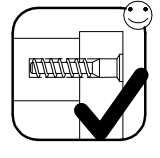
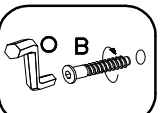

29

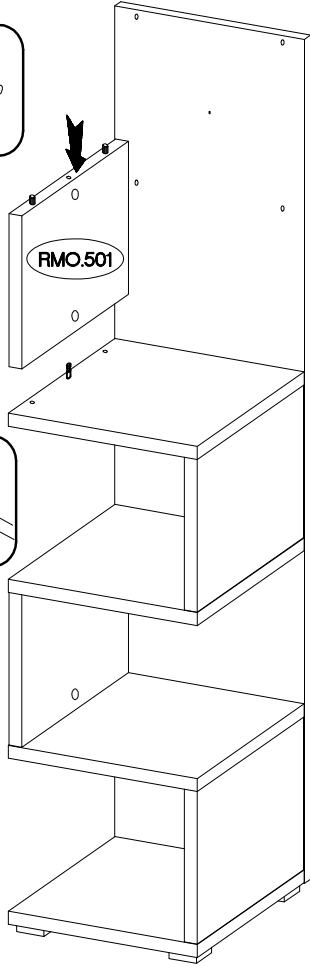
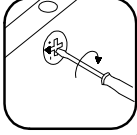
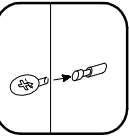

30

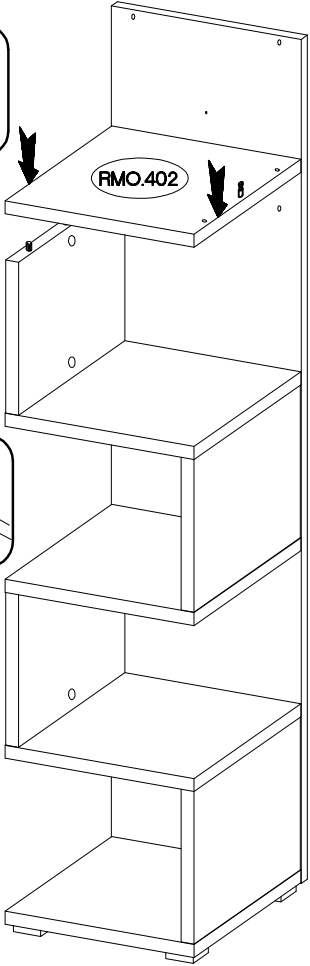
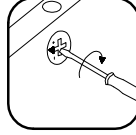
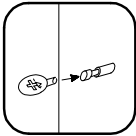

31

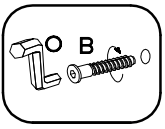

6,4 x 50mm



2

1

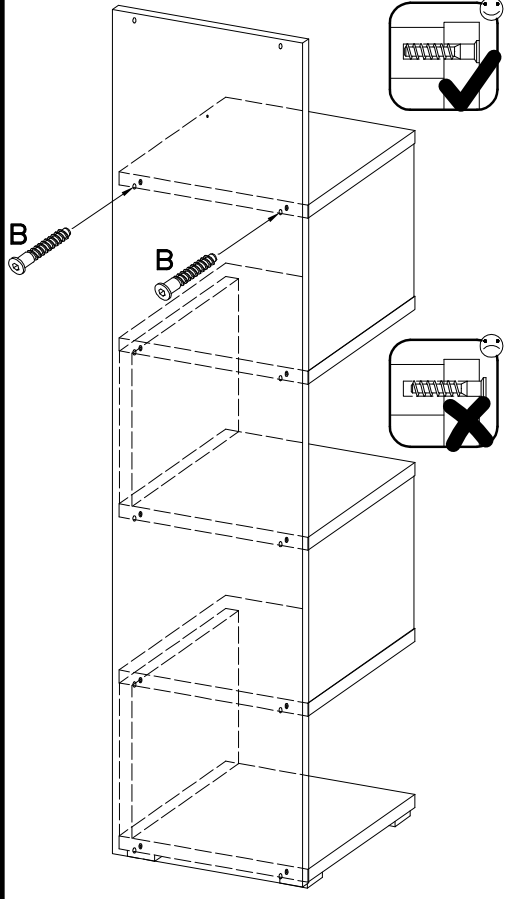

32

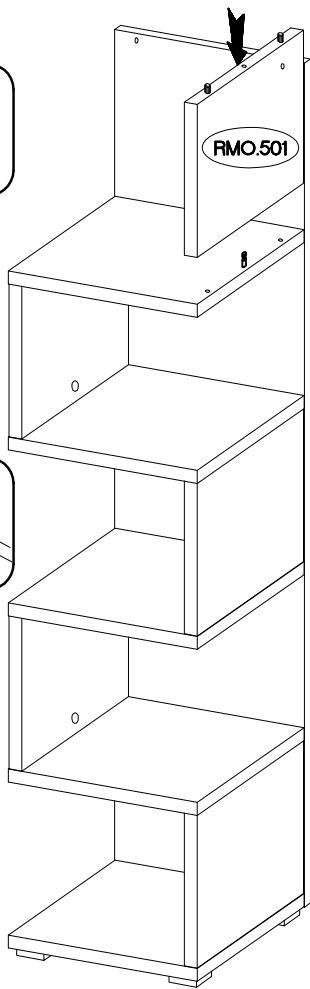
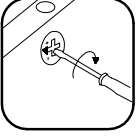
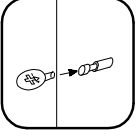

33

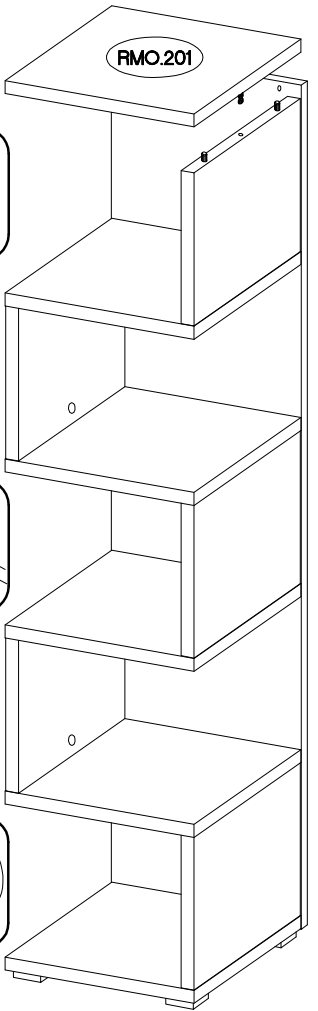
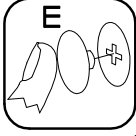
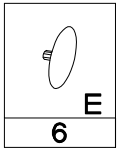
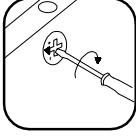
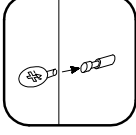

34



6,4 x 50mm

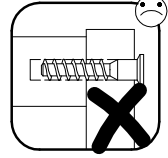
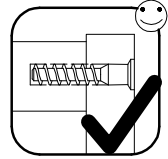
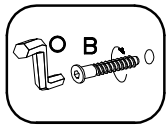
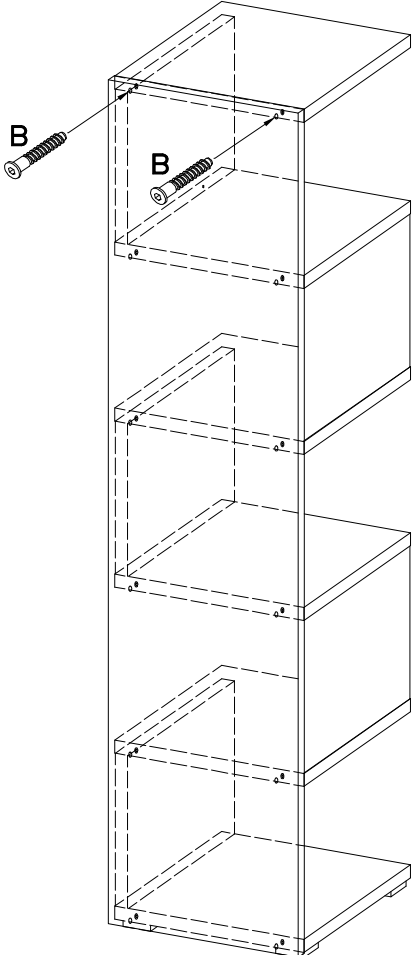

2

1



 #10x50mm O7 1	 #5.0x70mm P29 1	 #20 E11 1
--	--	--

