

60 min

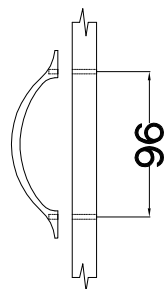

 <b>A</b> 16	 <b>B</b> 4
 <b>C</b> 12	 <b>D2</b> 12
 <b>O7</b> 2	 <b>P5</b> 22

 <b>E</b> 12	 <b>HG</b> 6	 <b>HG1</b> 3	 <b>J3</b> 24	 <b>J8</b> 36	 <b>L</b> 14	 <b>L2</b> 14	 <b>L19</b> 2	 <b>O</b> 1
 <b>P7</b> 25-30	 <b>P11</b> 36	 <b>P12</b> 2	 <b>S</b> 3	 <b>U</b> 6				

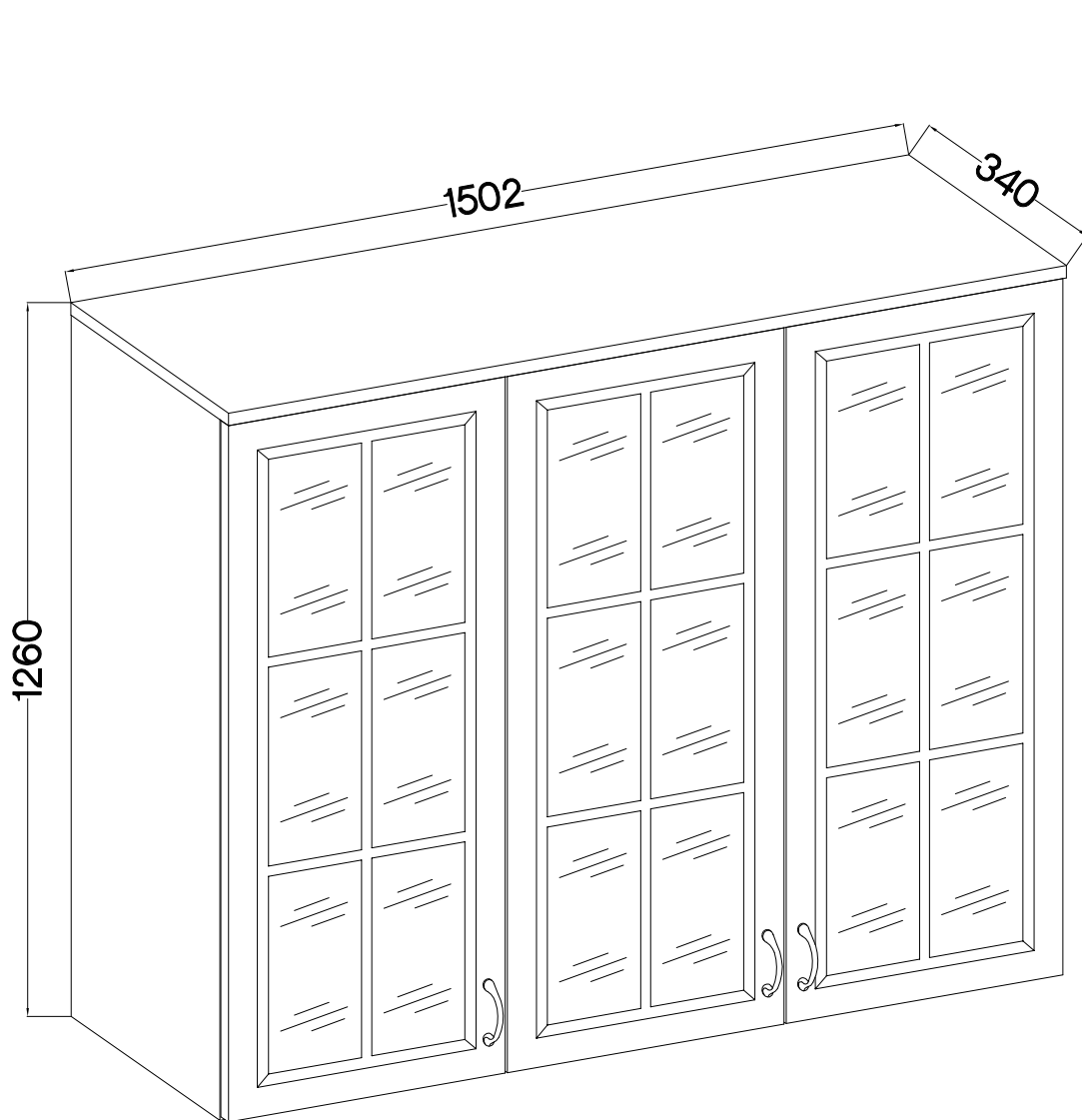
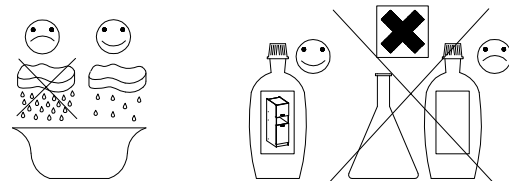
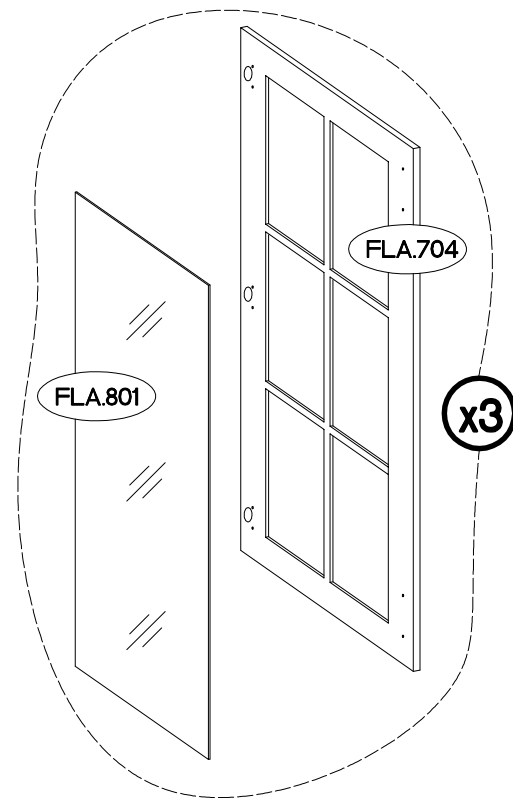
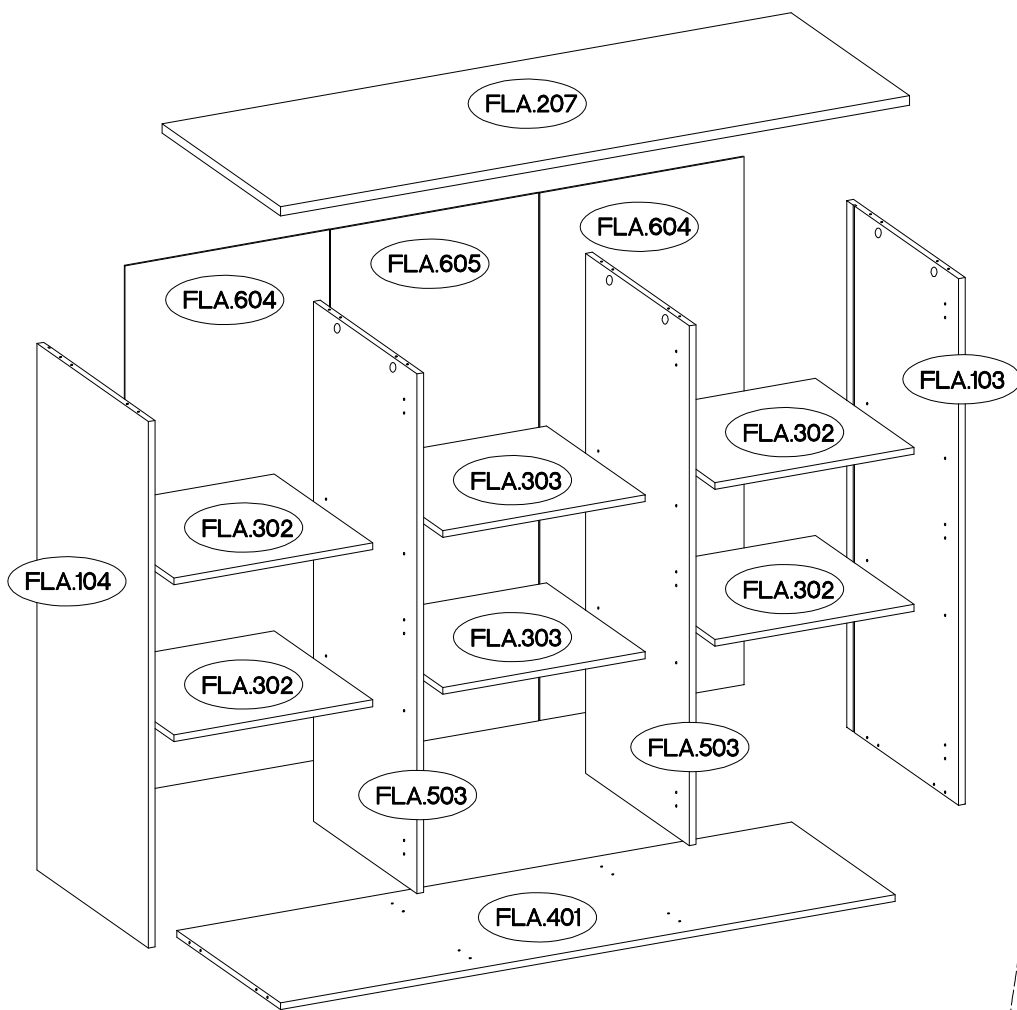

Colli		
Colli 1/3	FLA.302 x4	475x283x16
	FLA.303 x2	483x283x16
	FLA.401	1468x297x16
	FLA.503 x2	1222x297x16

Colli		
Colli 2/3	FLA.103	1238x320x16
	FLA.104	1238x320x16
	FLA.207	1502x340x22

Colli		
Colli 3/3	FLA.604 x2	1241x488x2.5
	FLA.605	1241x498x2.5
	FLA.704 x3	1229x496x16
	FLA.801 x3	1115x382x4





FLA.302

FLA.303

FLA.401

1

±8x30mm  A 16	±15/12mm  C 12	L=20mm  D2 4
--	---	---

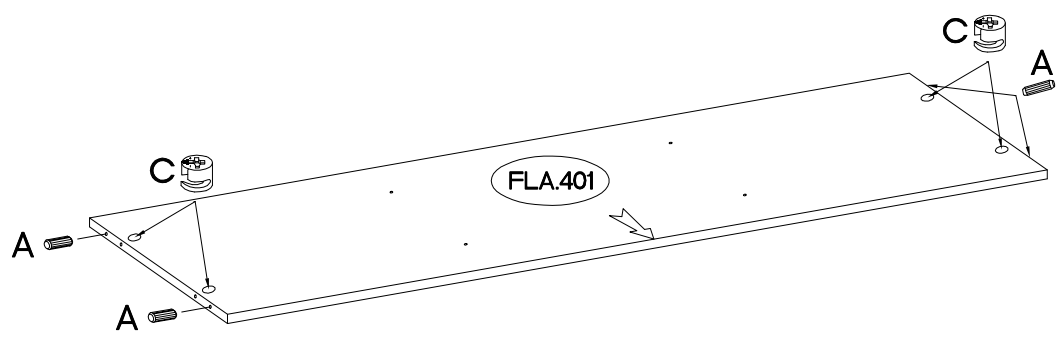
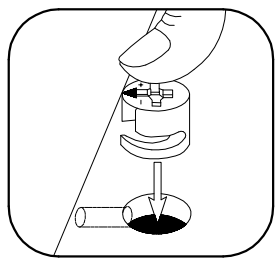
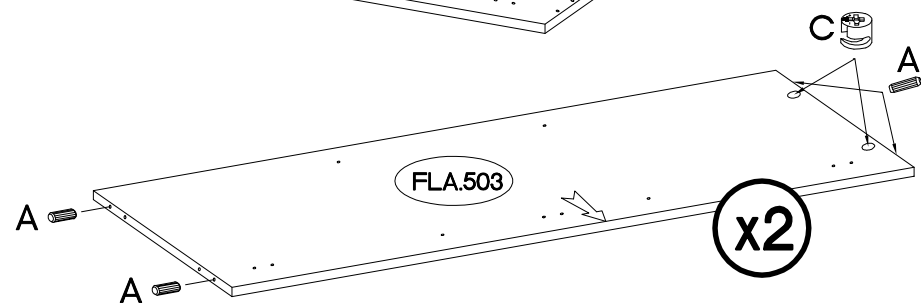
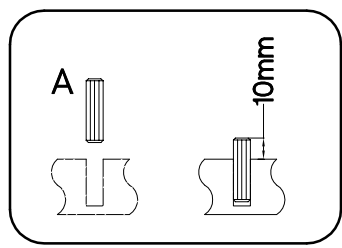
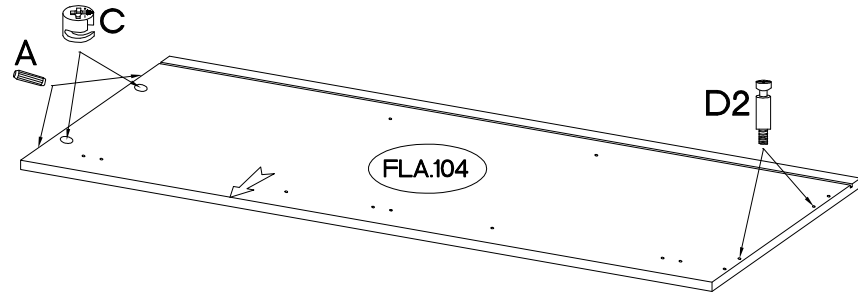
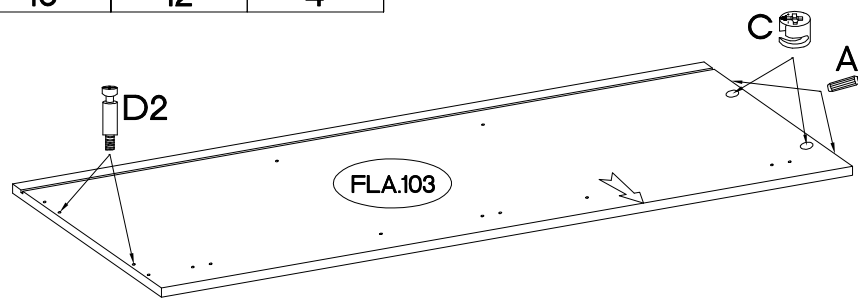
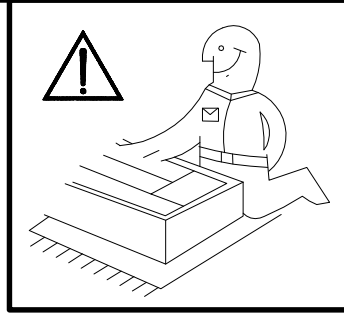

2

L=20mm  D2 8
--

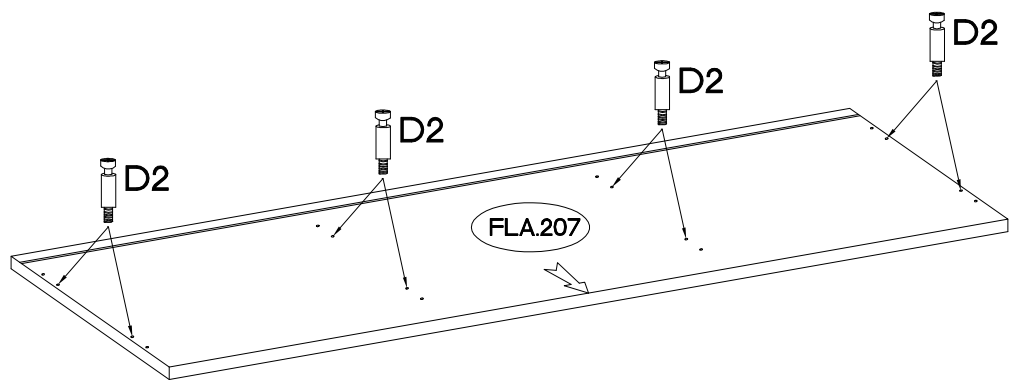
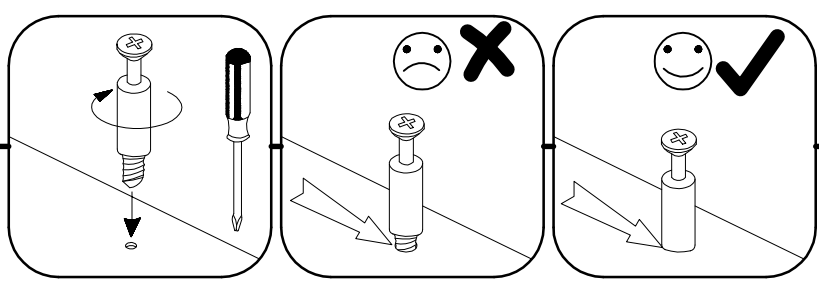

3

6,4 x 50mm

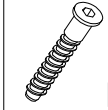

4

1

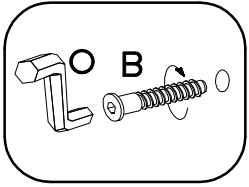
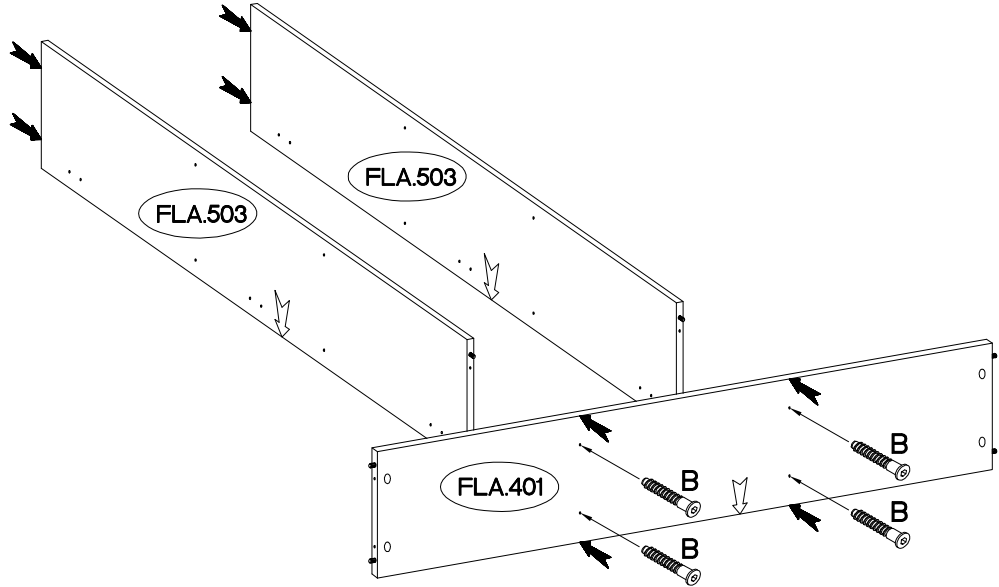
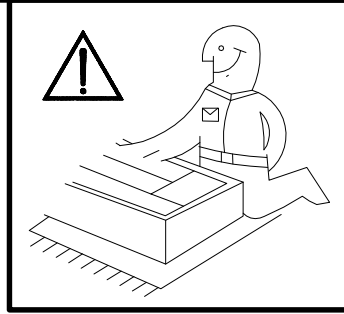
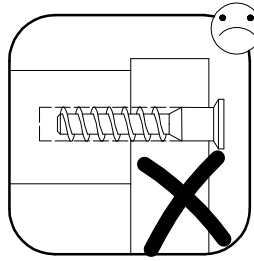
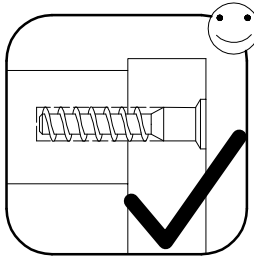

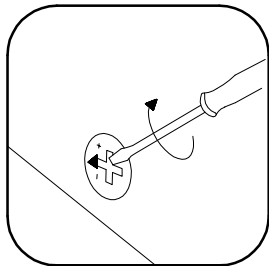
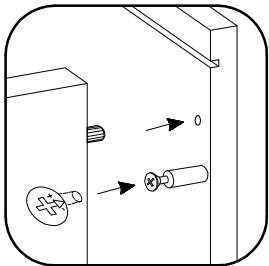
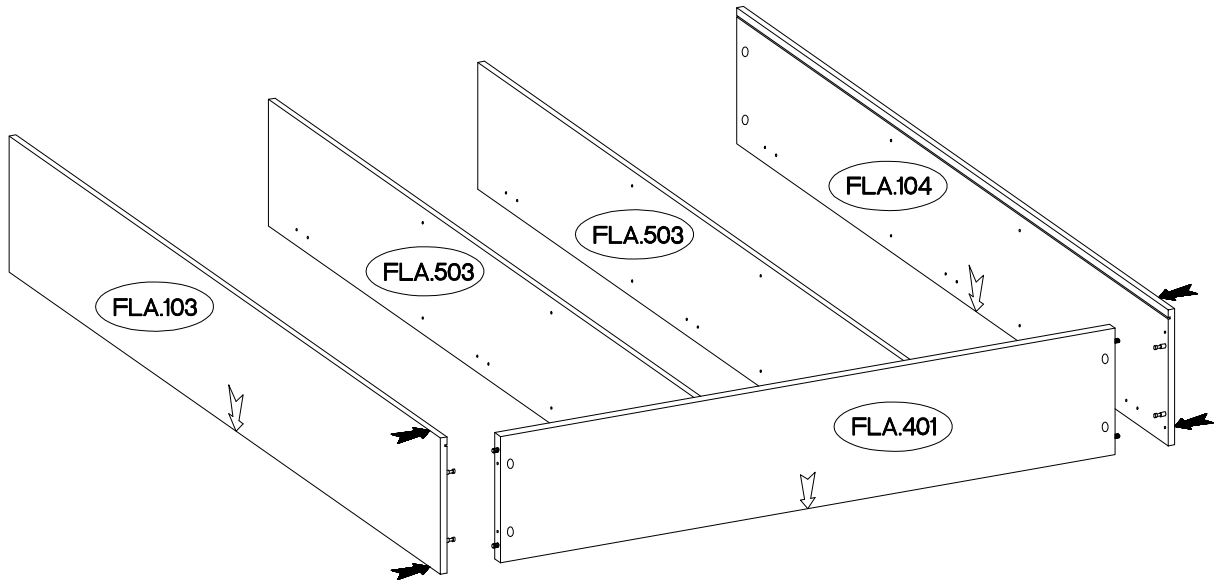

4

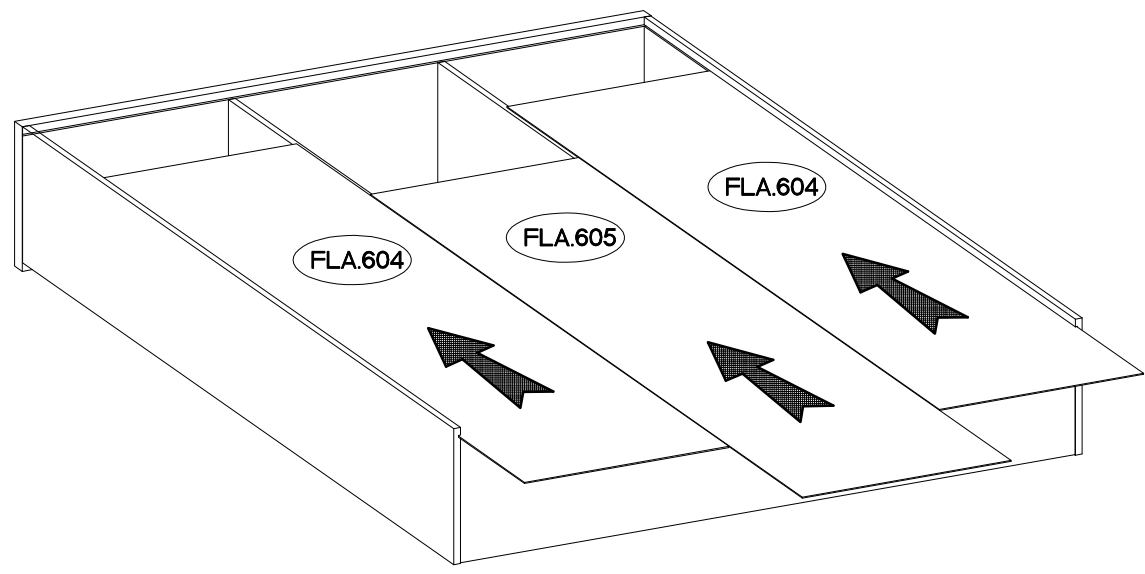
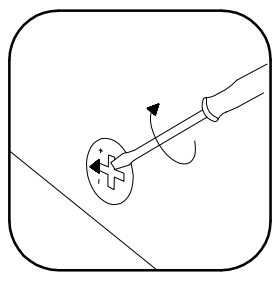
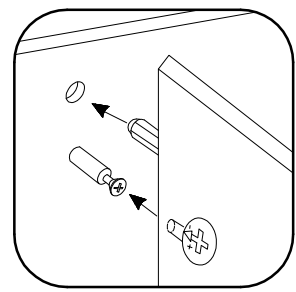
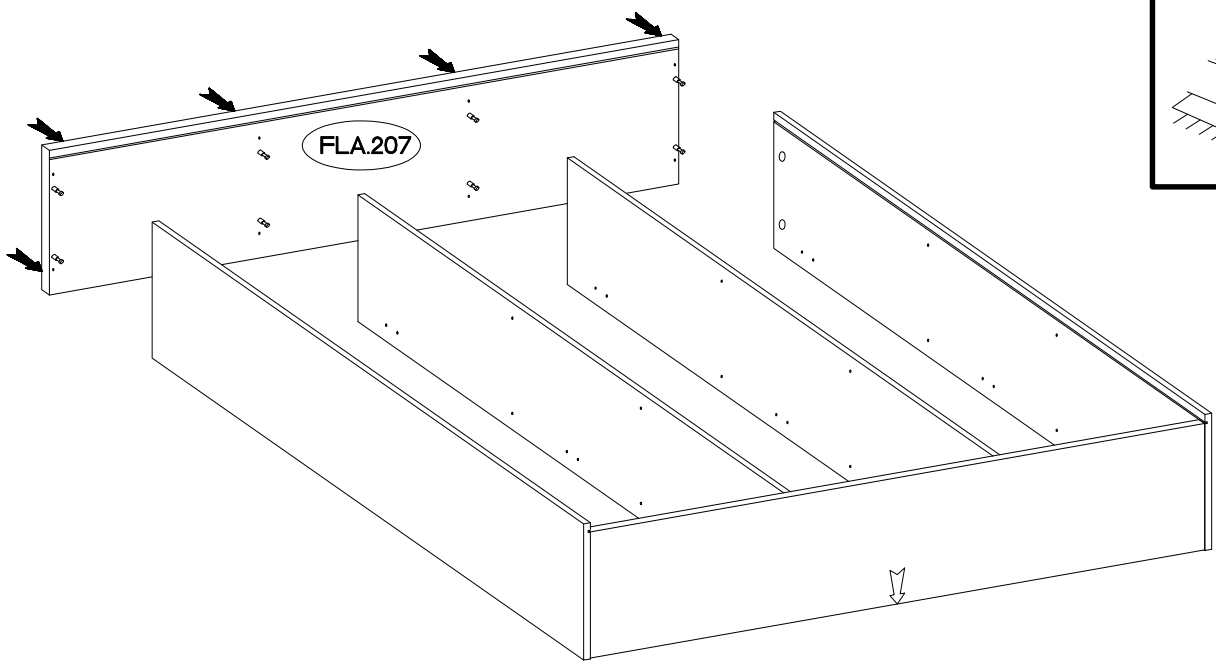
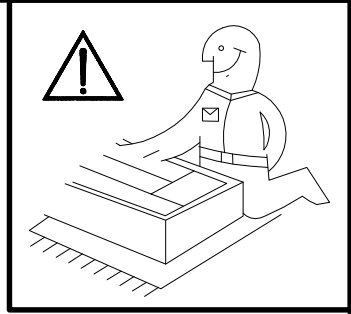

5





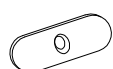

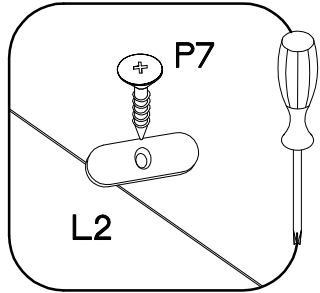
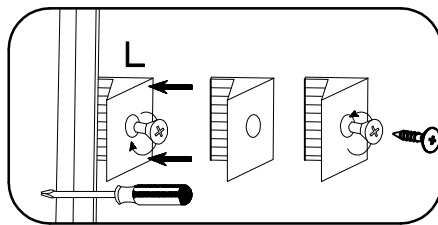
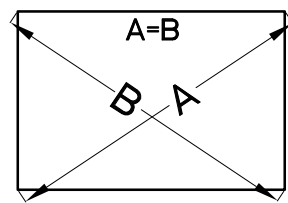
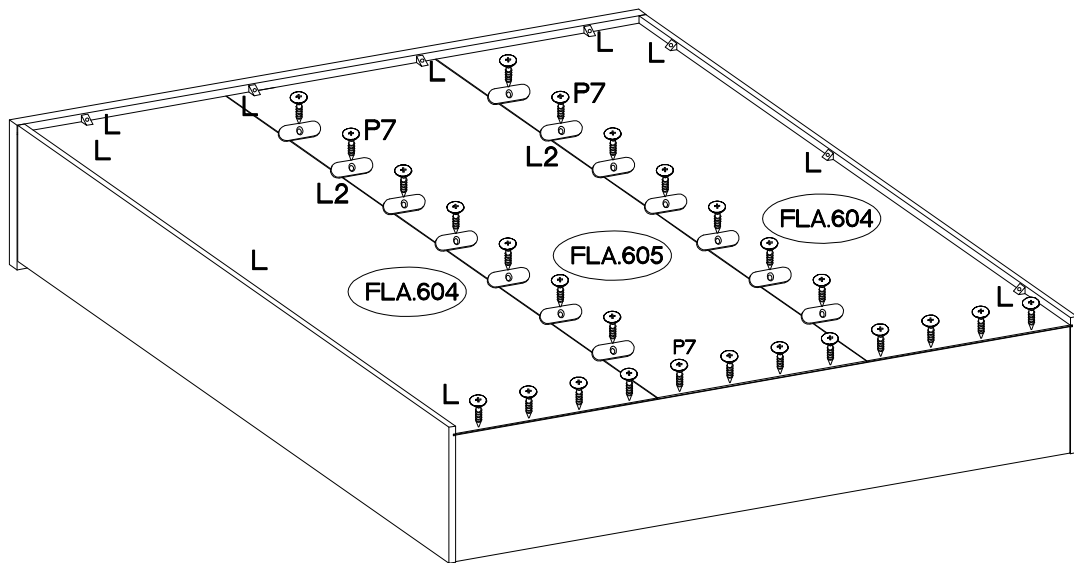
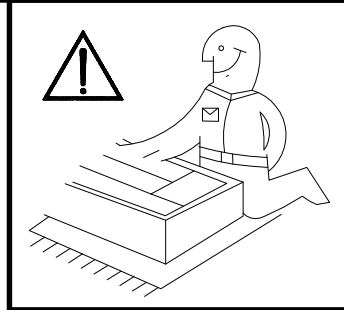
6

	±3.0x20mm 	
L	P7	L2
14	25-30	14

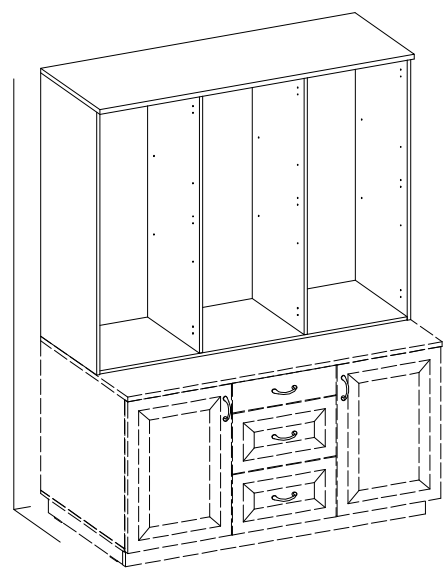
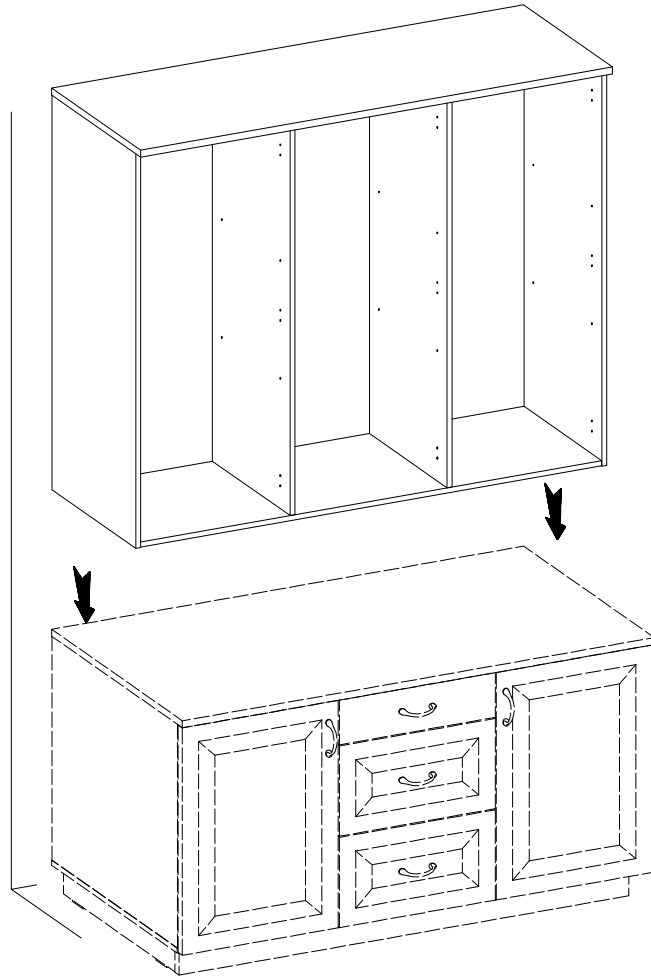
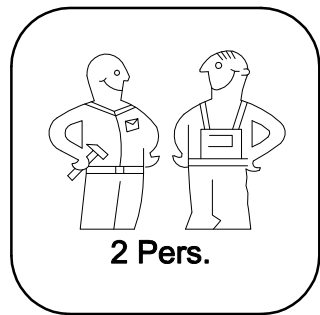

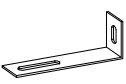

7

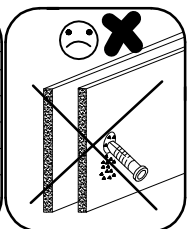
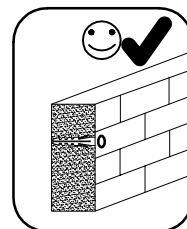
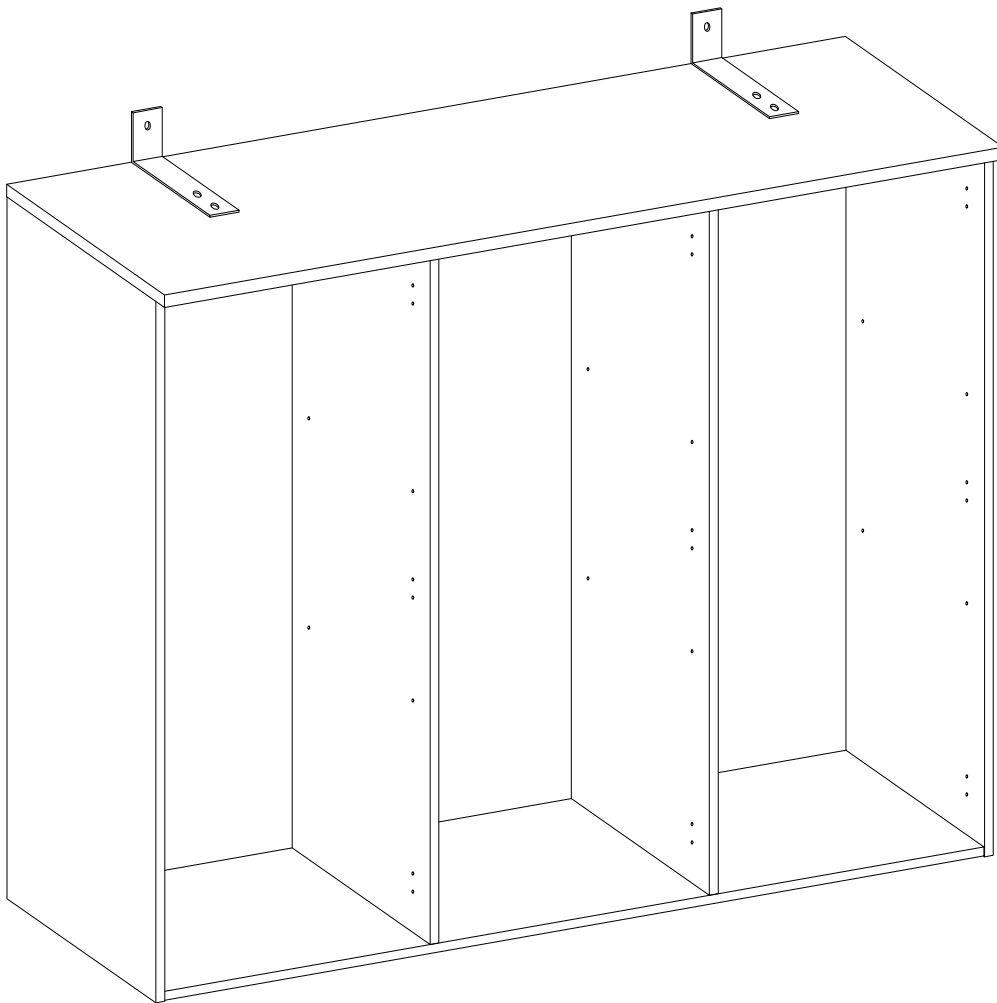
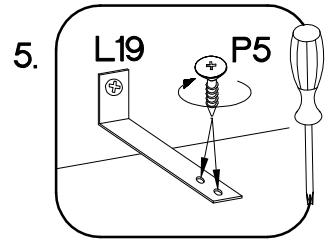
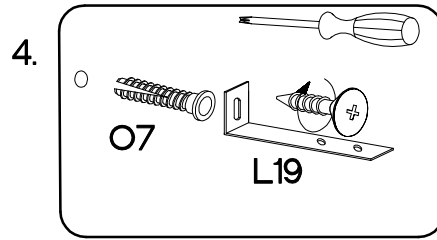
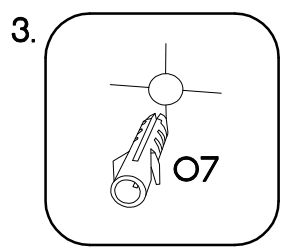
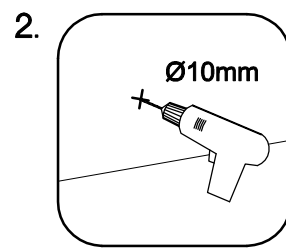
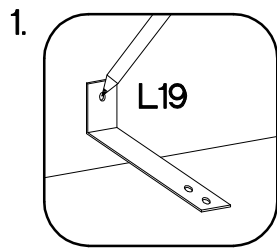

	3.5x13mm	5.0x60mm	10x50mm
			
L19	P5	P12	O7
2	4	2	2



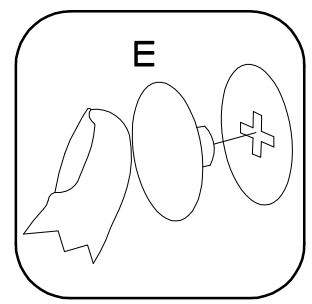
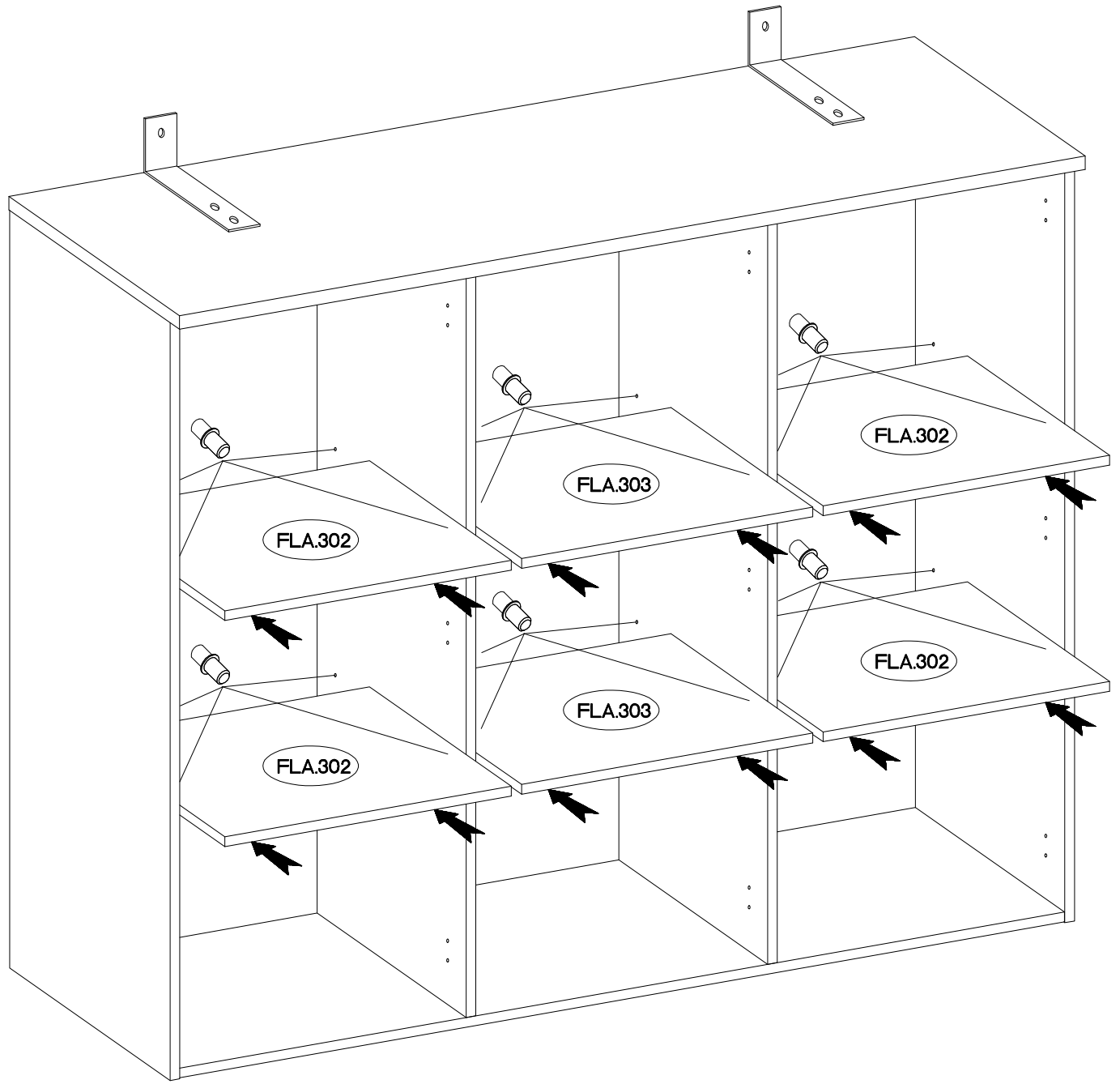
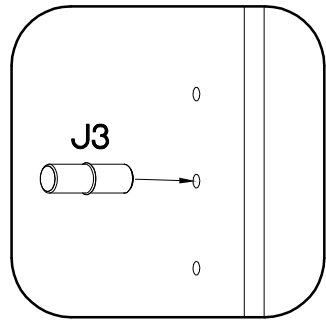

±5/16mm		
J3		E
24		12



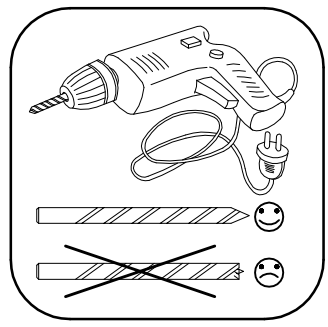
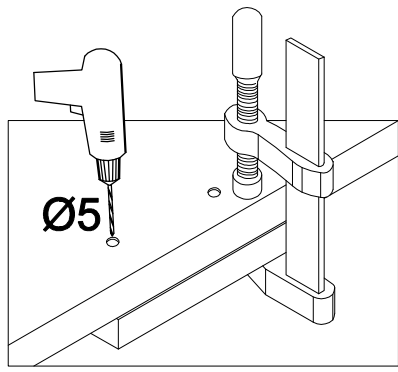
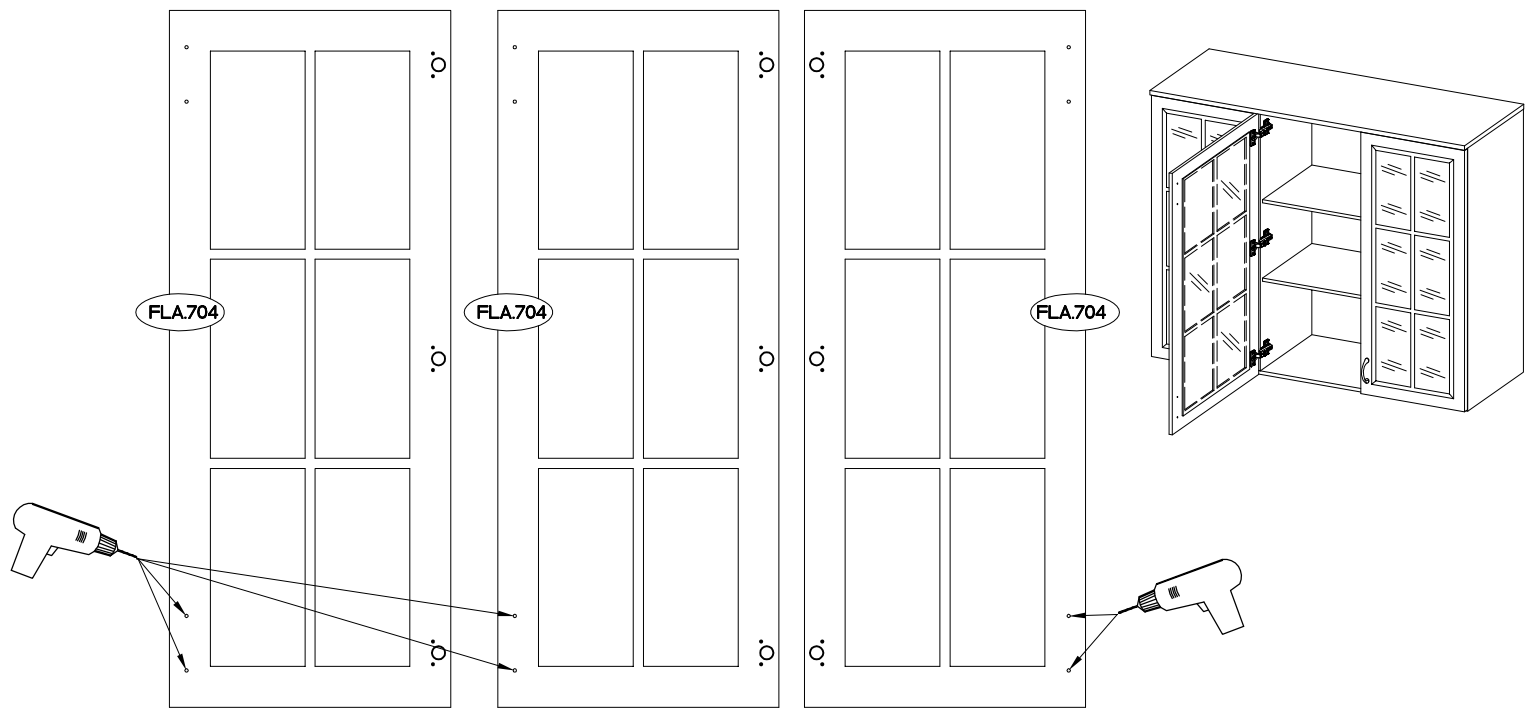
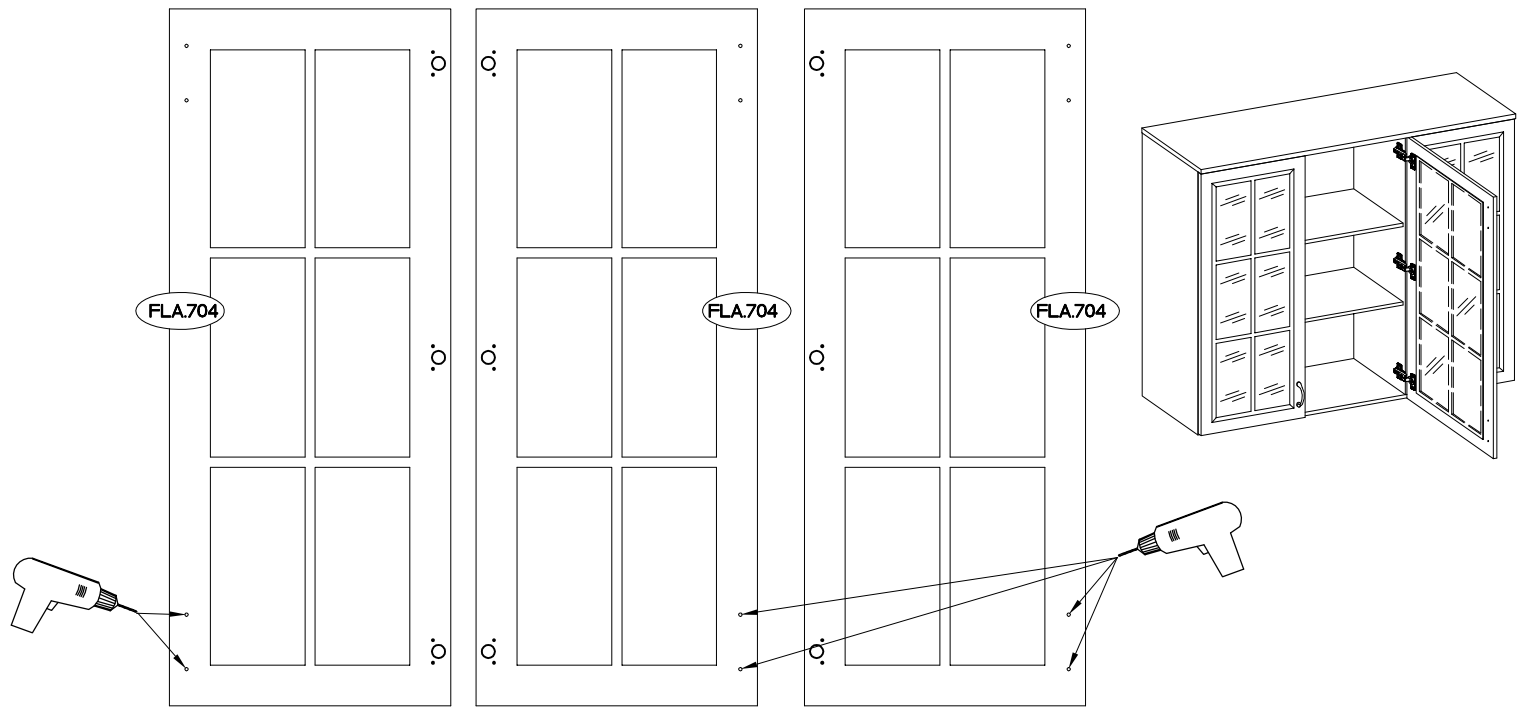

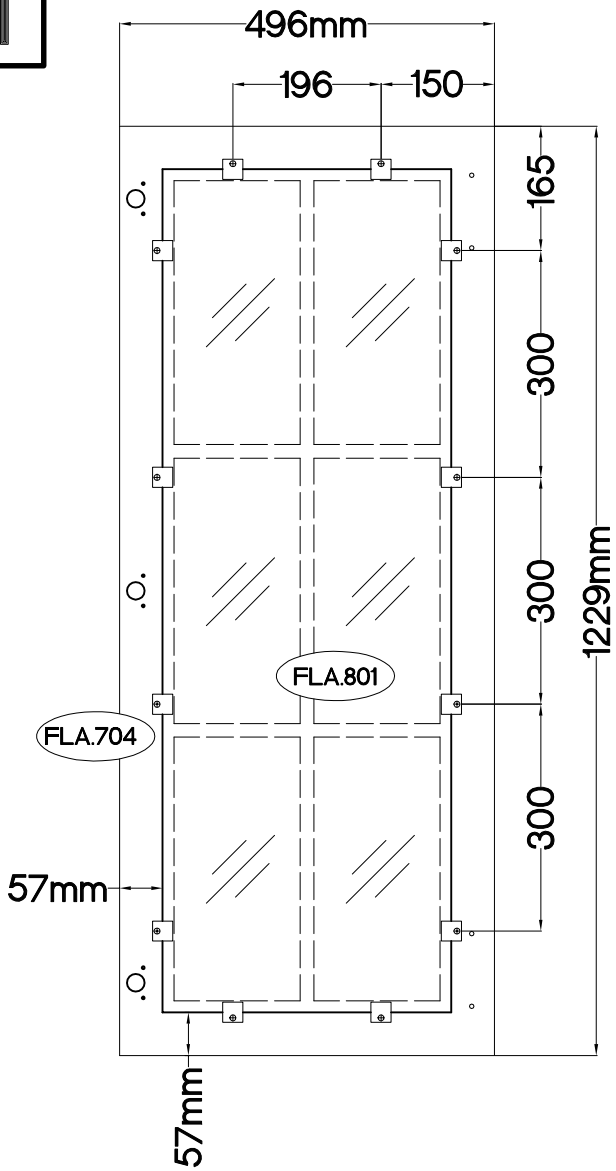

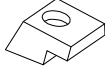



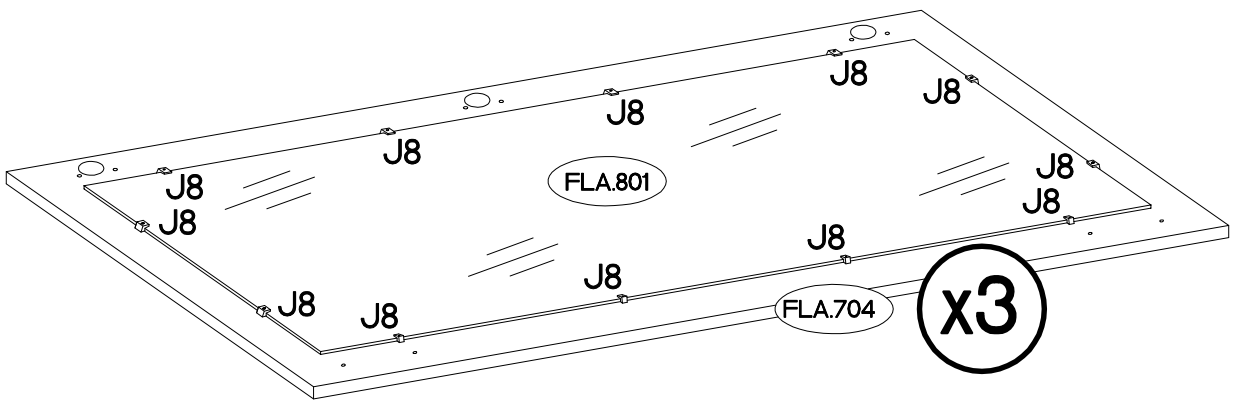
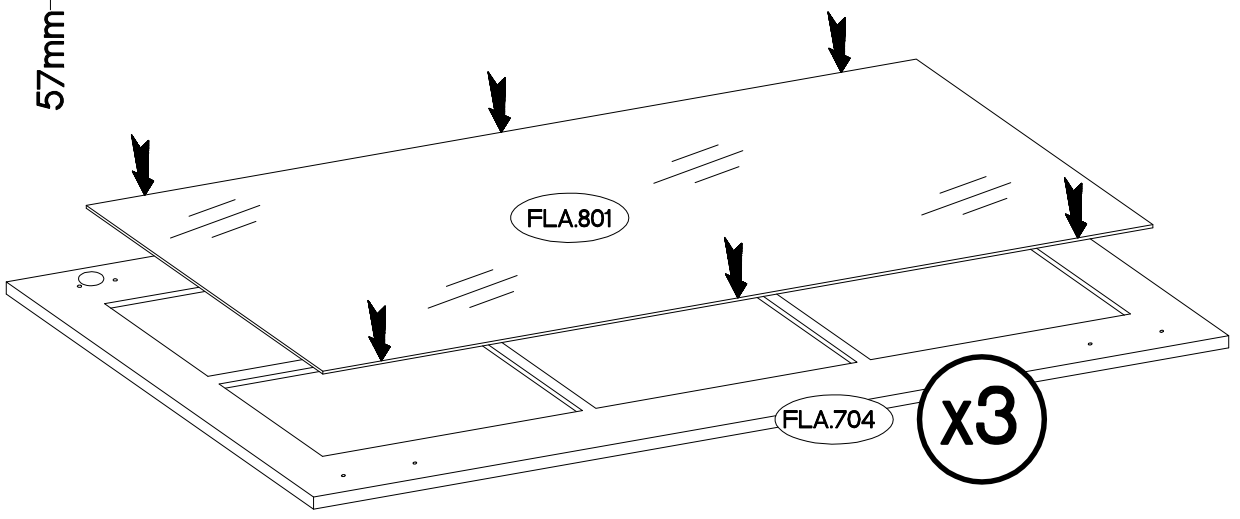
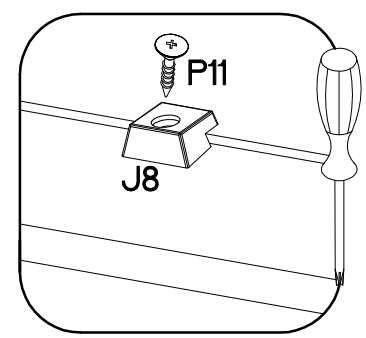
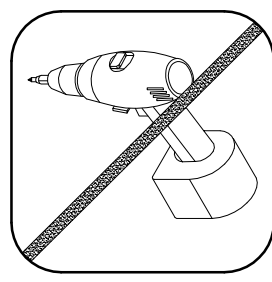
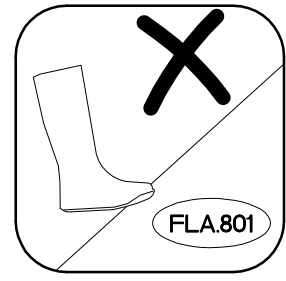
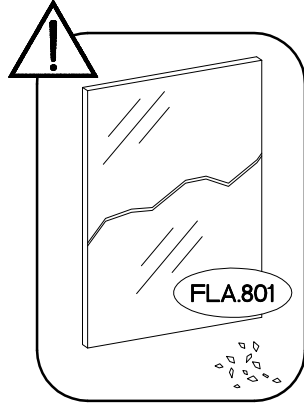
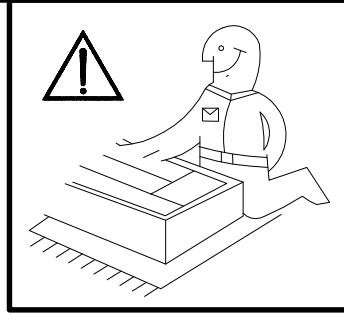

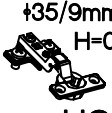

	+3.0x16mm 
J8	P11
36	36



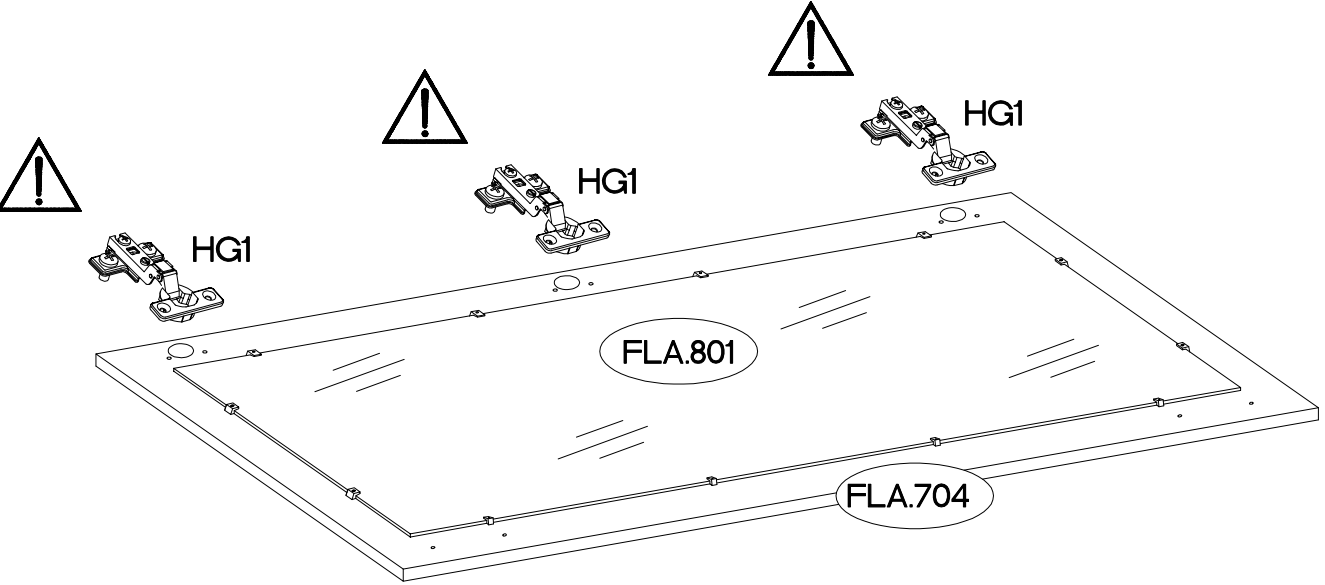
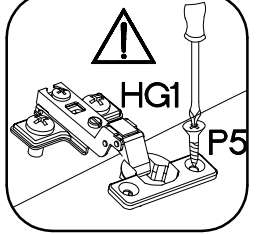
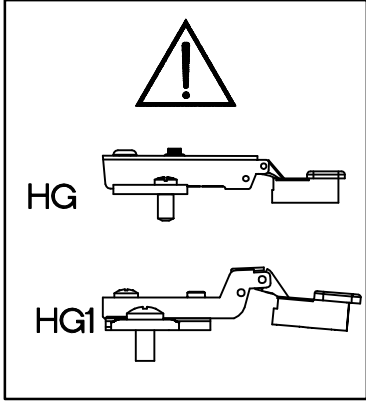
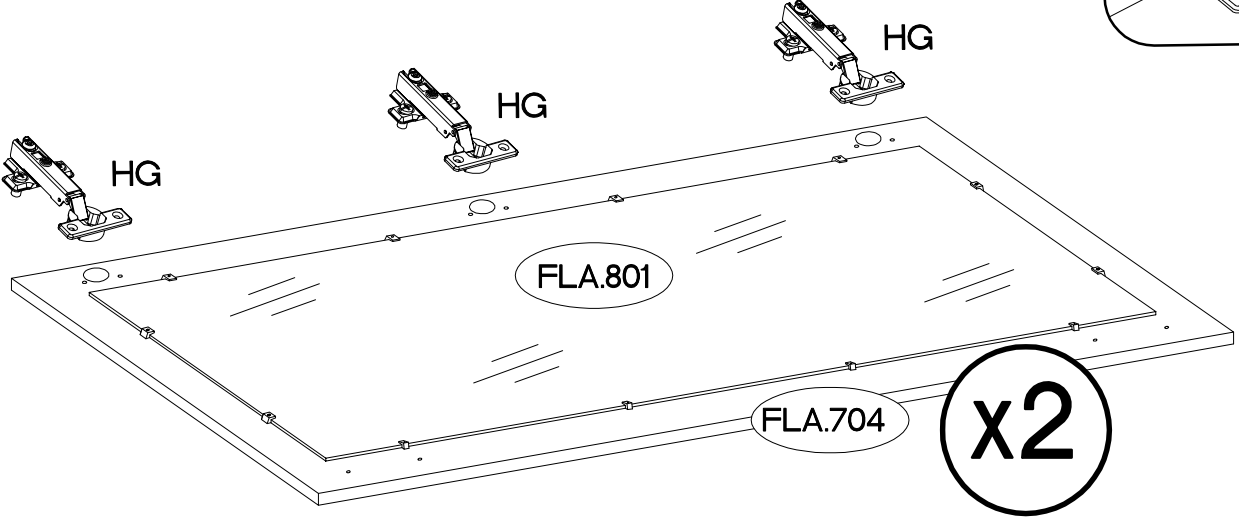
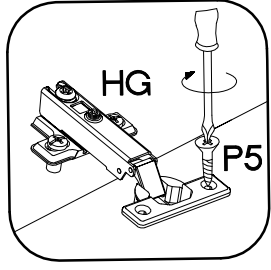

 HG 6	 HG1 3	 P5 18
---	--	--

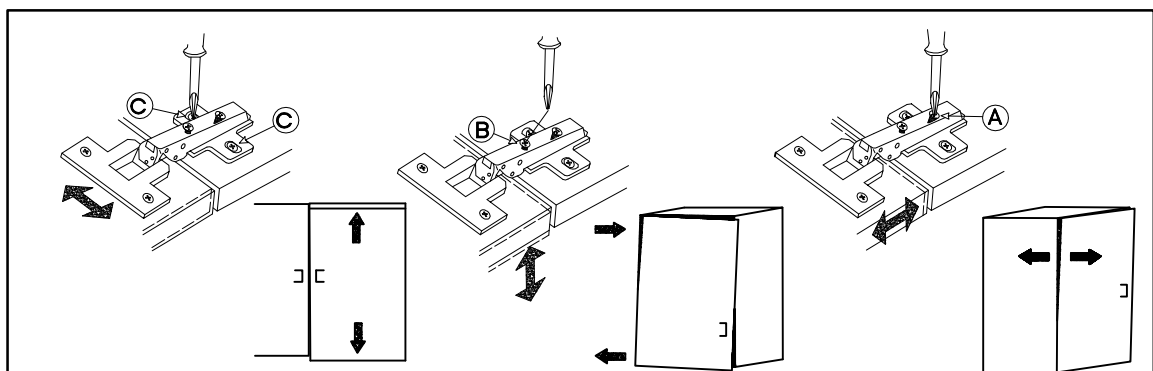
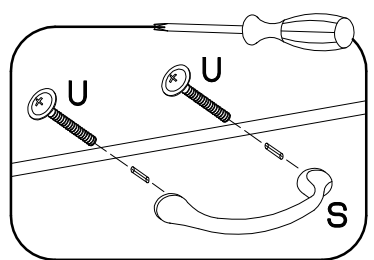
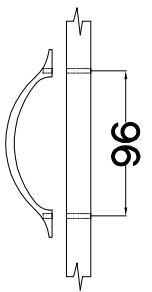
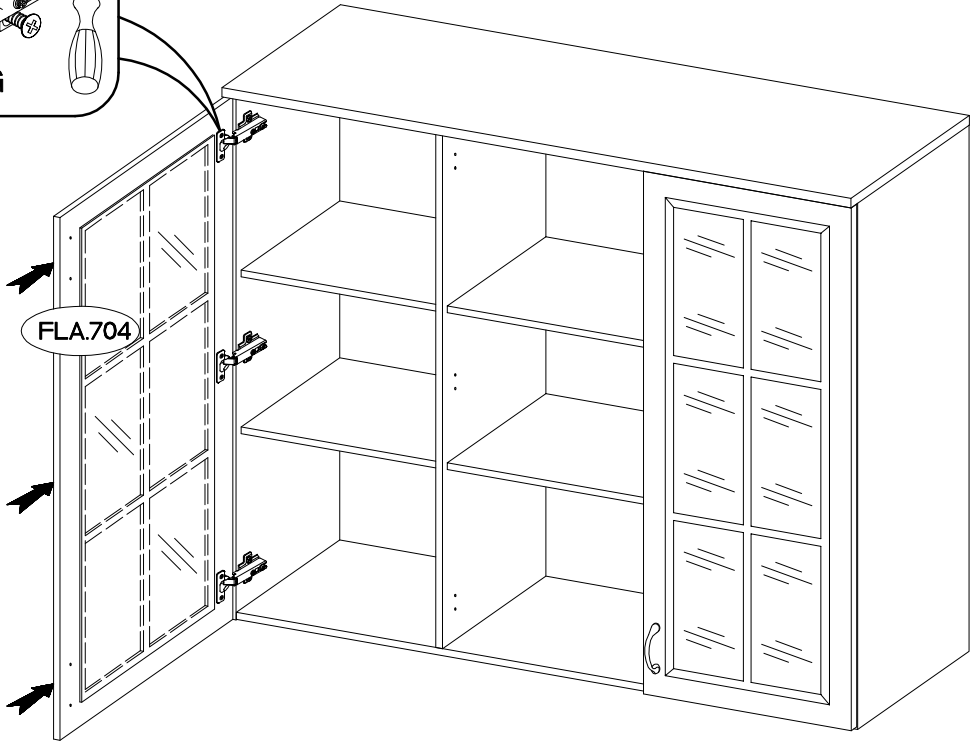
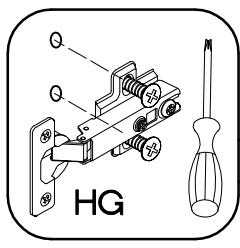
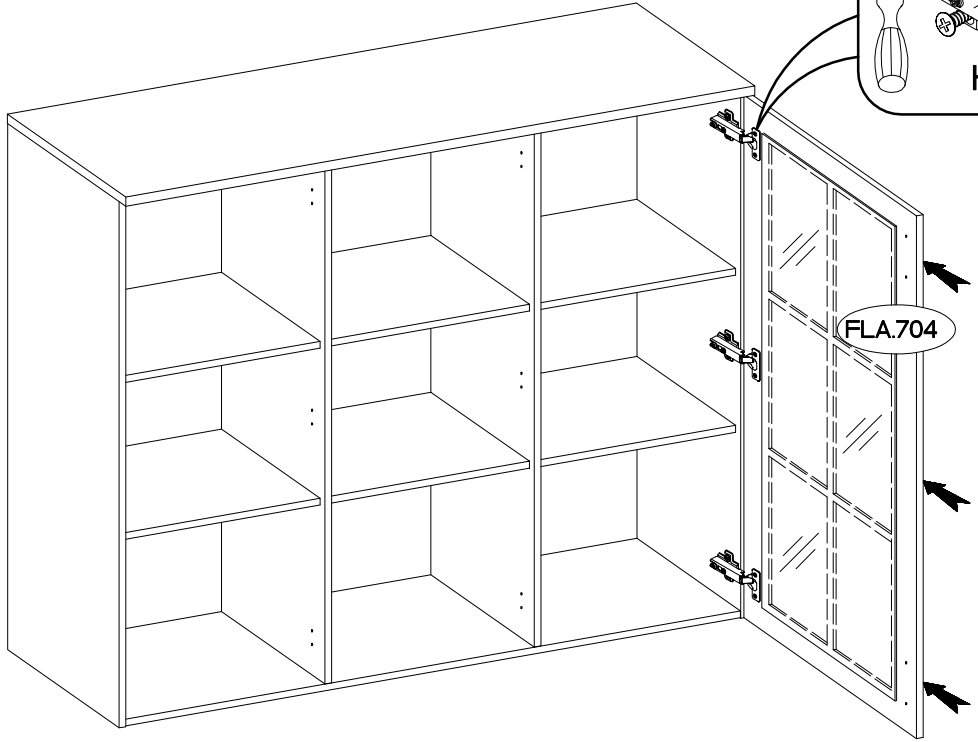
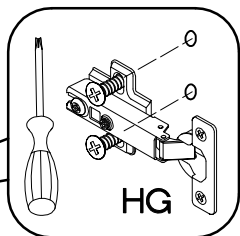

M4x22mm	
	
U	S
4	2



M4x22mm	
	
U	S
2	1

