

 <b>A</b> 20	 <b>B</b> 4	 <b>C</b> 20	 <b>D2</b> 20	 <b>E11</b> 20	 <b>F19</b> 4	 <b>F20</b> 4	 <b>[CD] HG</b> 2	 <b>J3</b> 4	 <b>O</b> 1	 <b>P5</b> 4	 <b>R11</b> 16	 <b>S</b> 1	 <b>U</b> 2
--------------------	-------------------	--------------------	---------------------	----------------------	---------------------	---------------------	-------------------------	--------------------	-------------------	--------------------	----------------------	-------------------	-------------------

MTA.121	1500x400x18
MTA.122	1500x400x18
MTA.213	452x422x18
MTA.214	452x422x18
MTA.305	413x365x18
MTA.407 x3	414x398x18
MTA.712	427x445x16
MTA.910	414x414x18



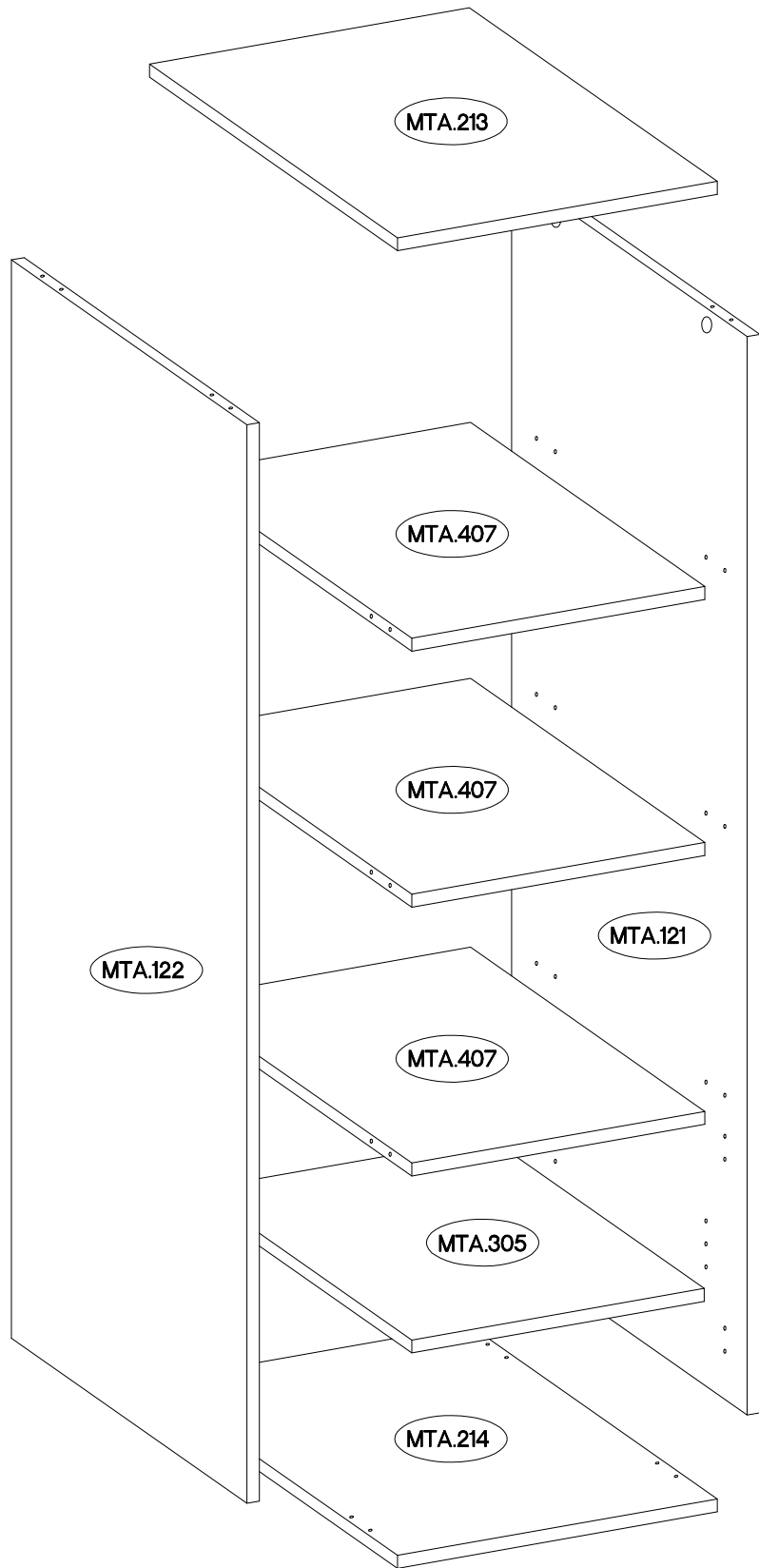
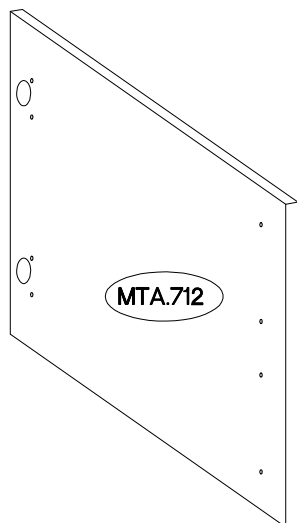
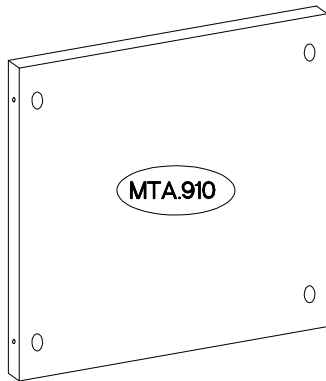

MTA.305

MTA.407



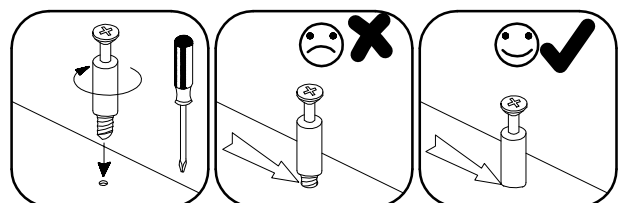
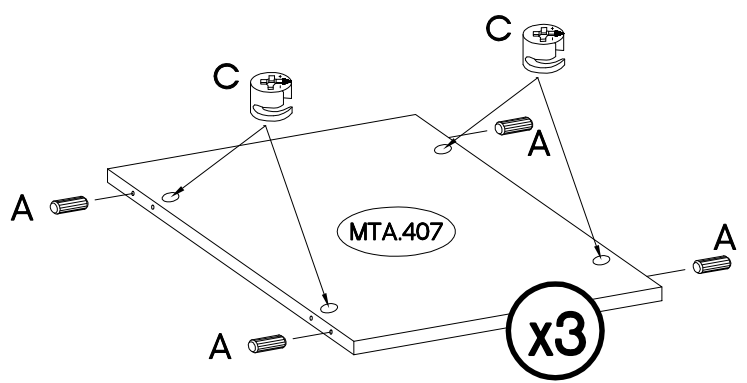
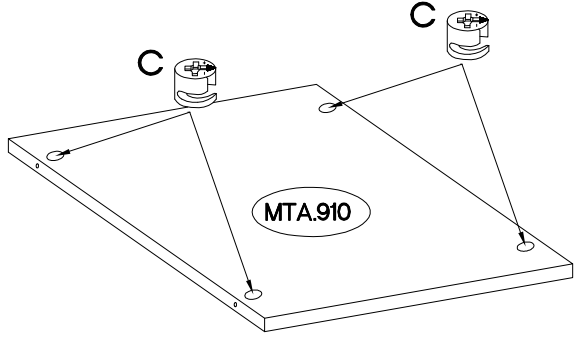
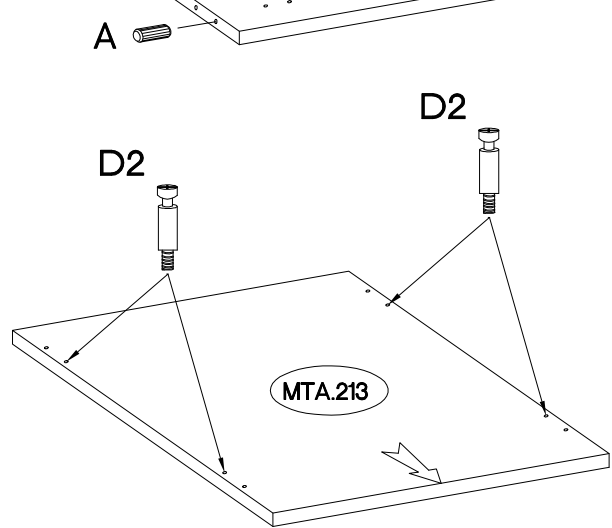
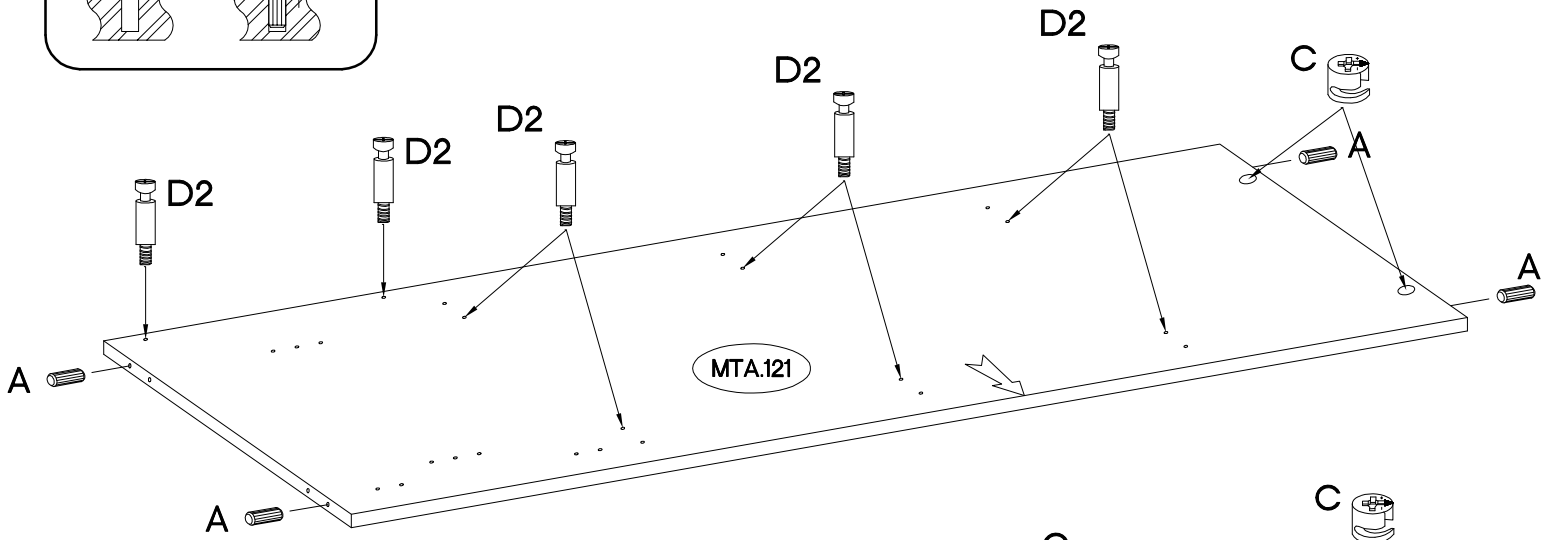
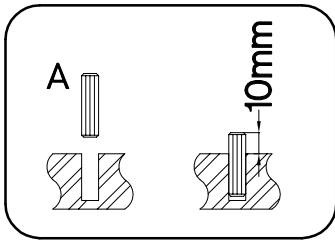
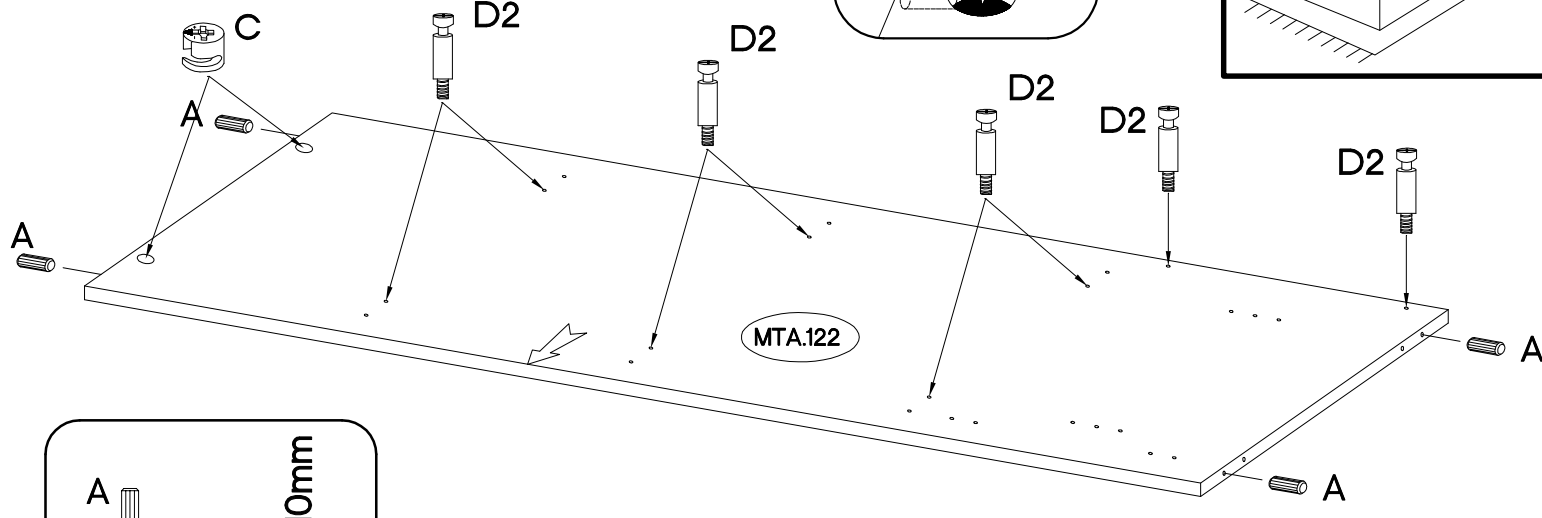
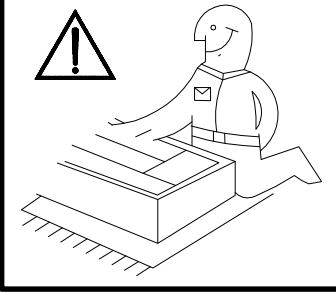
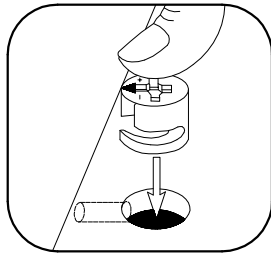

1

$\varnothing 8 \times 30 \text{mm}$  A 20	L=20mm  D2 20	$\varnothing 15/12 \text{mm}$  C 20
--	--	--

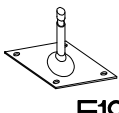

# 2

$\pm 4.0 \times 16 \text{mm}$  R11 16	 F19 4	 F20 4
--	--	--

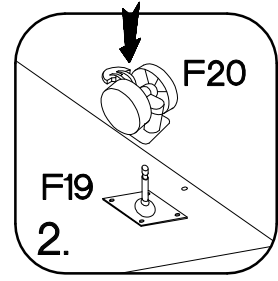
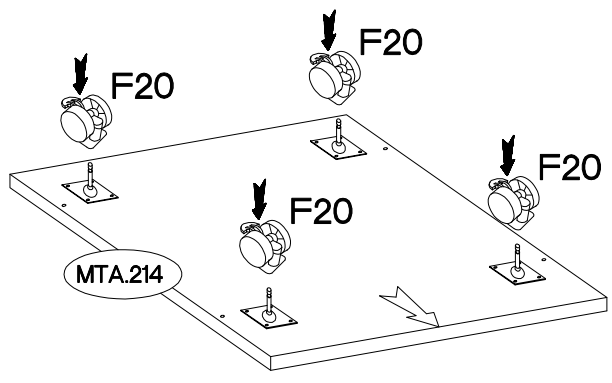
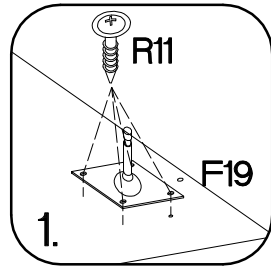
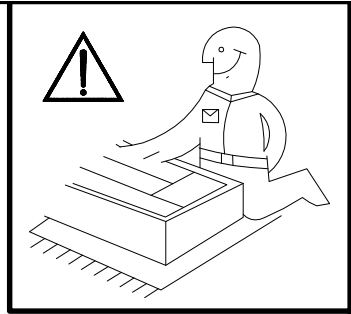

# 3

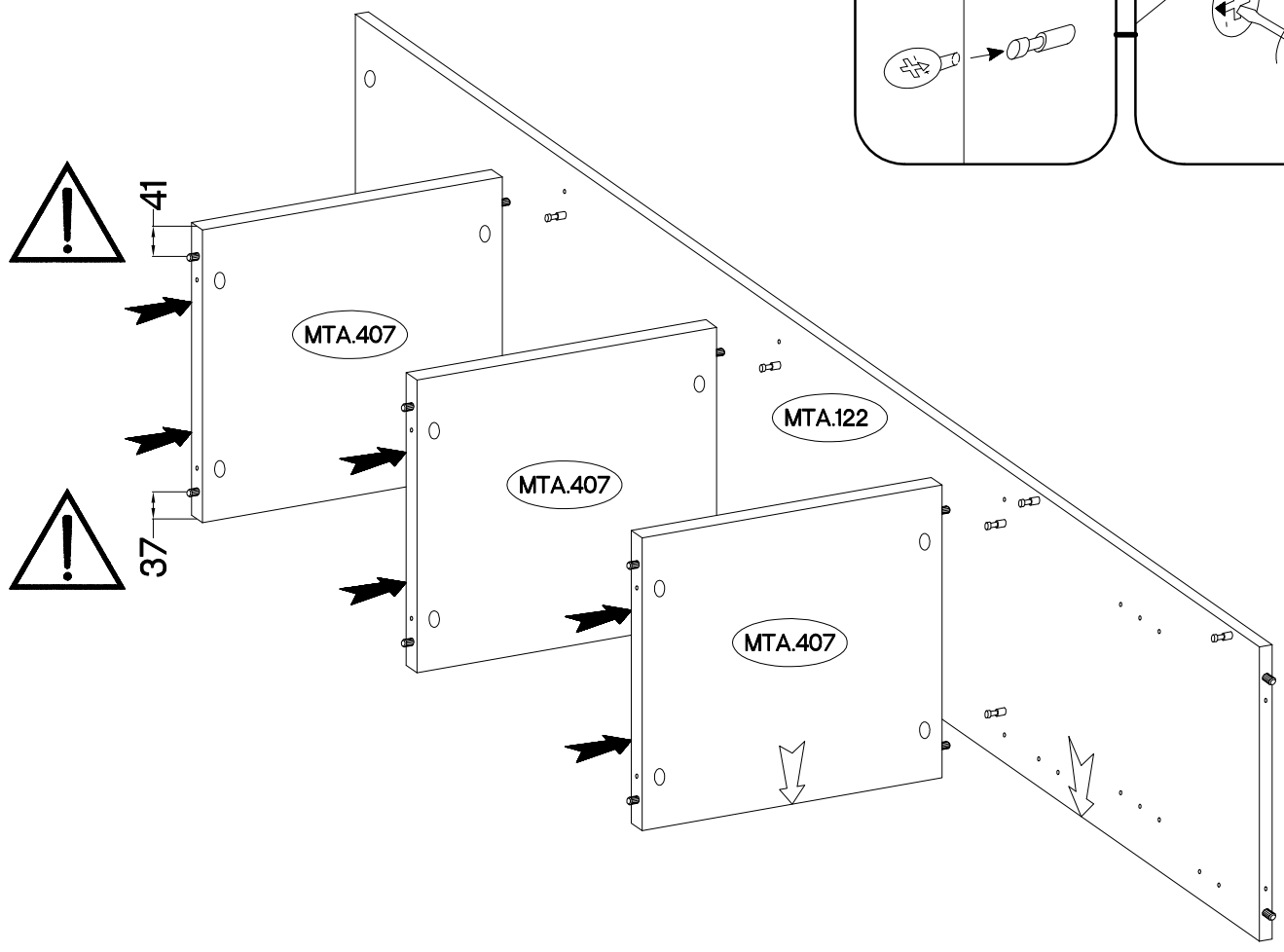
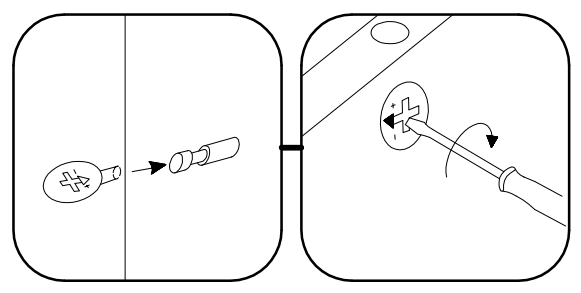

4

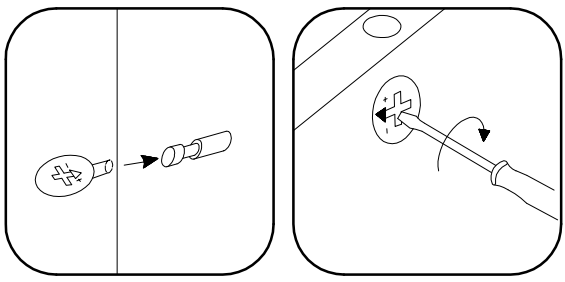
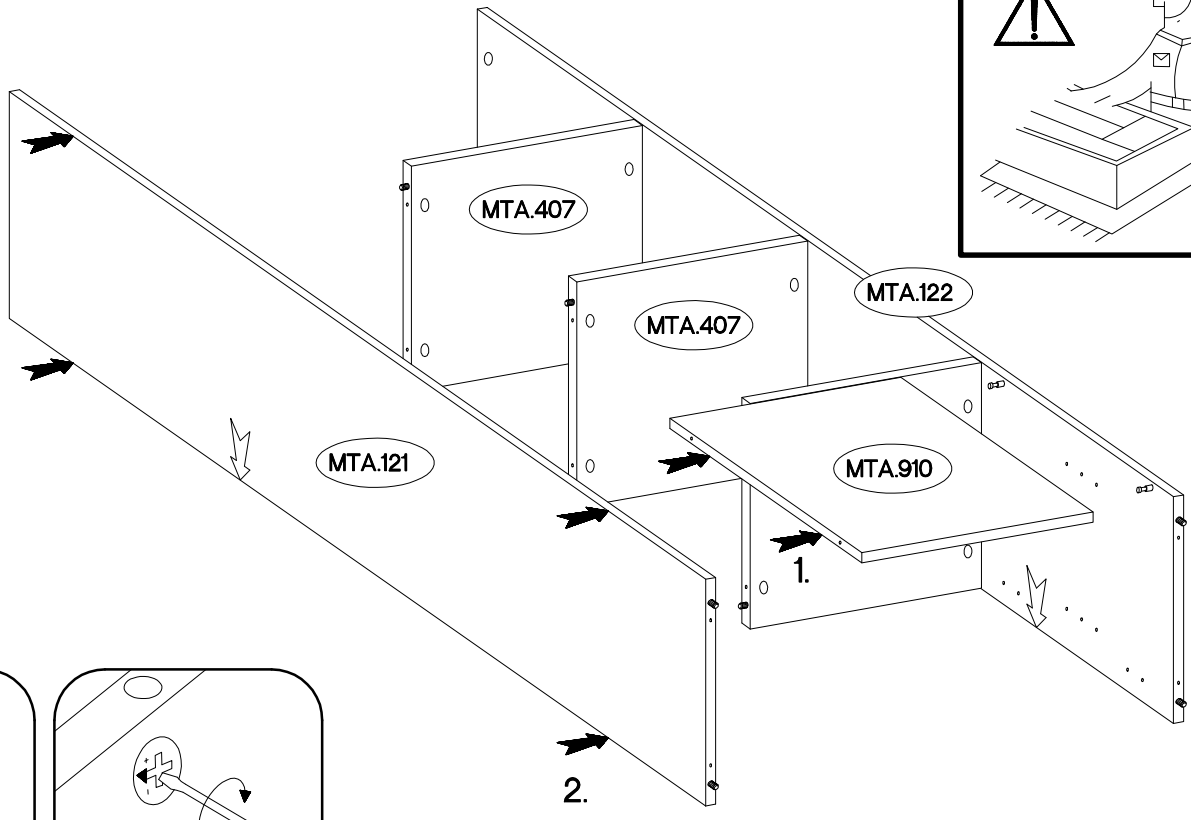
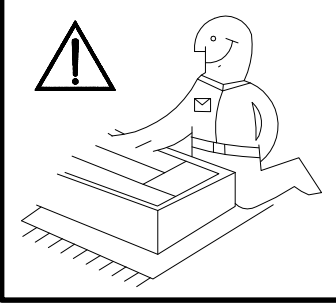

5

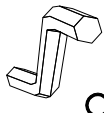
6,4 x 50mm	
	
B	O
4	1

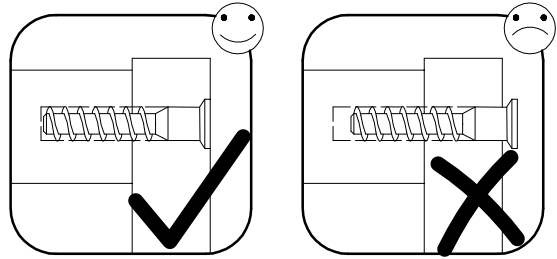
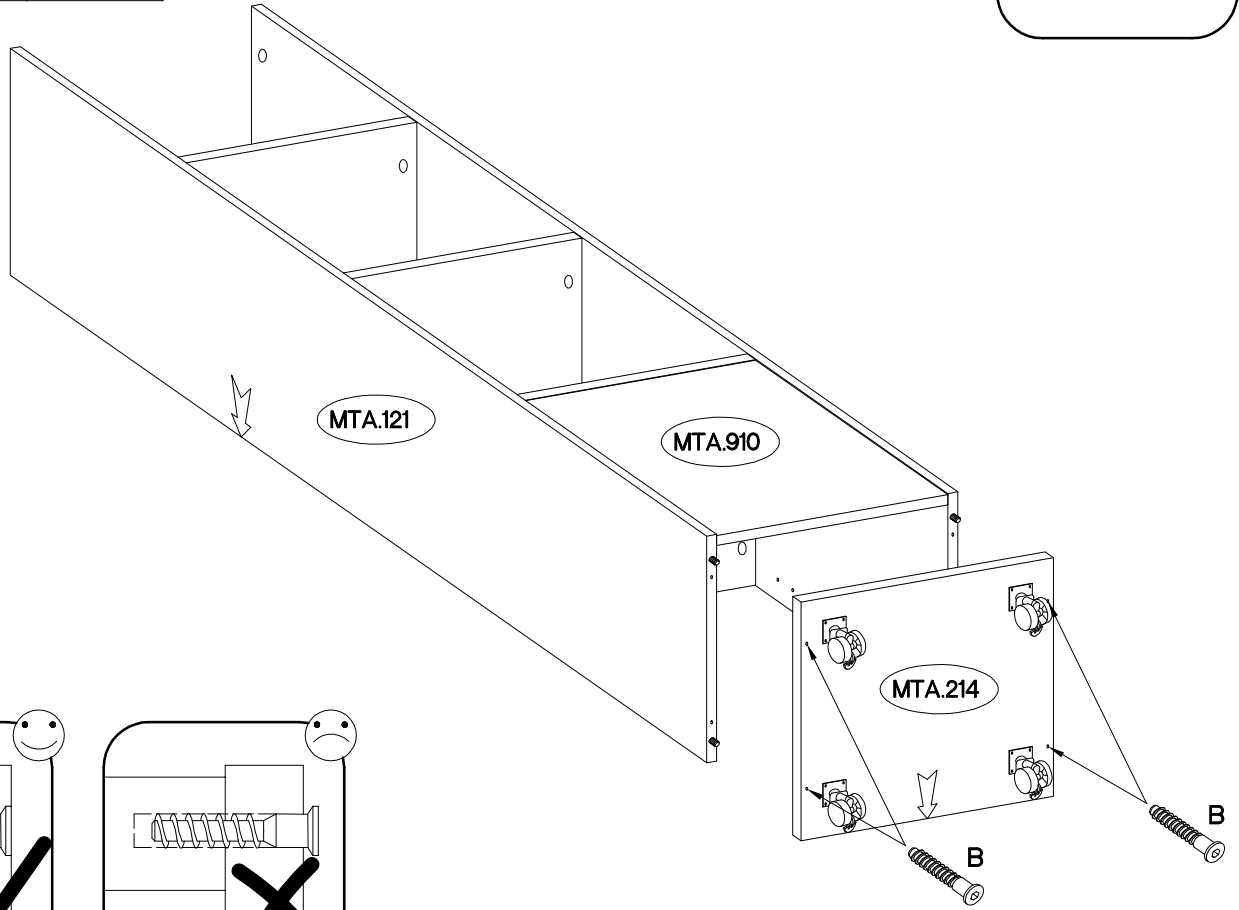
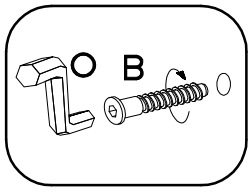

6

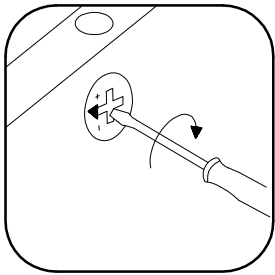
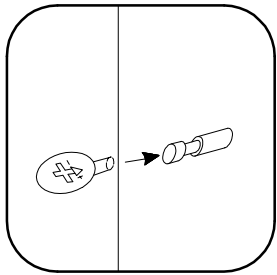
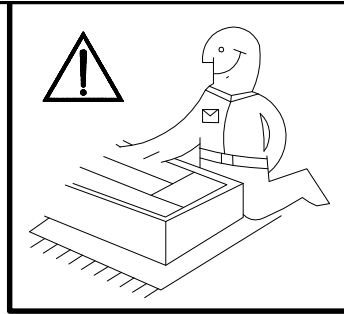
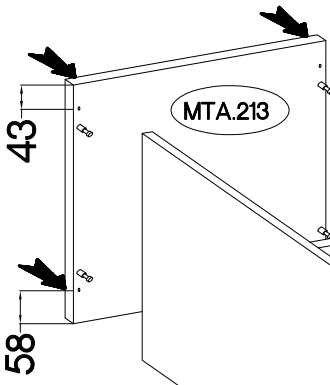



MTA.121

MTA.910

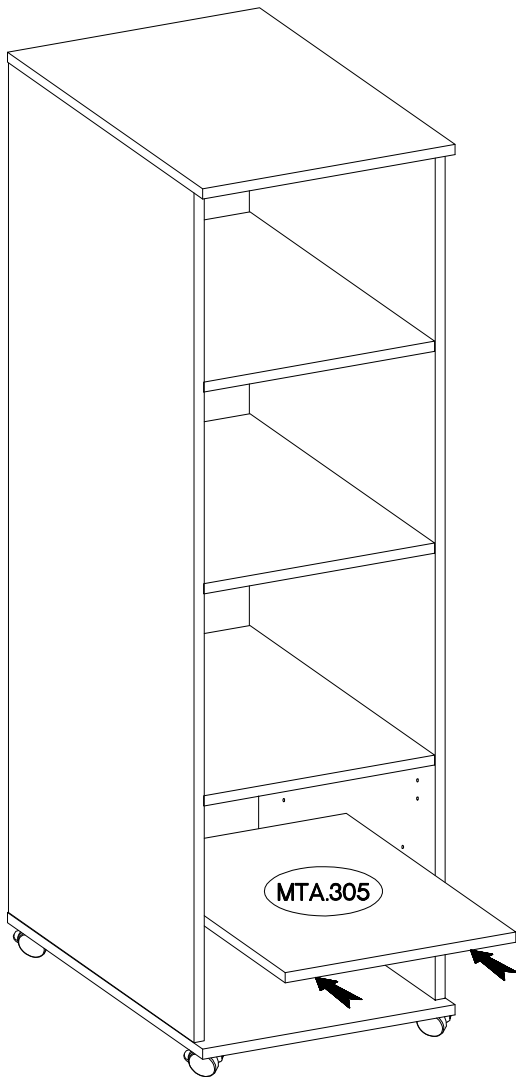

MTA.214

7

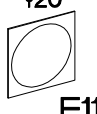

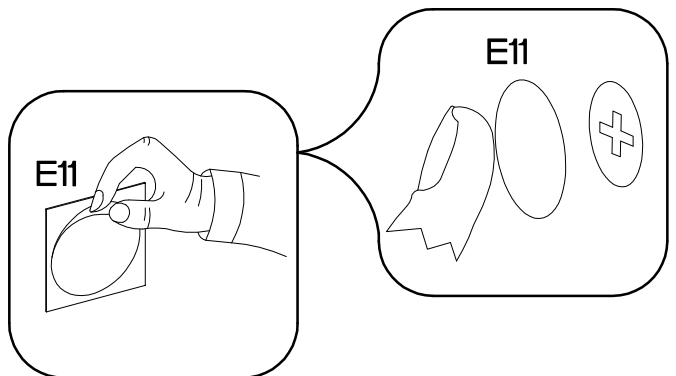
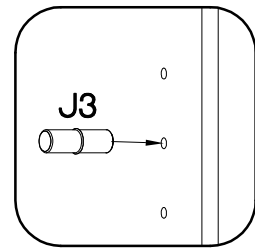

±5/16mm  J3 4	±20  E11 20
---	---

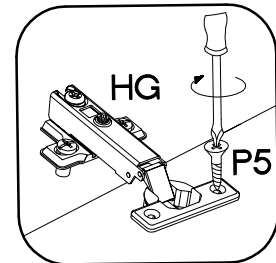
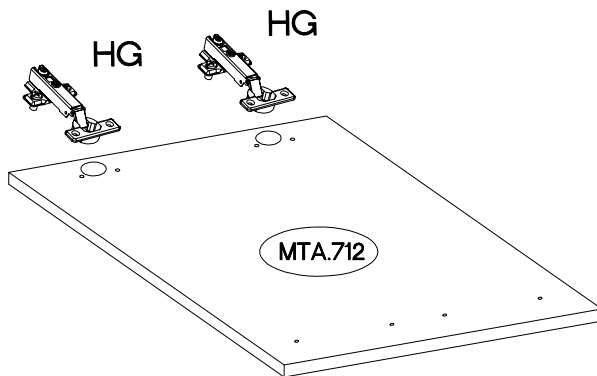
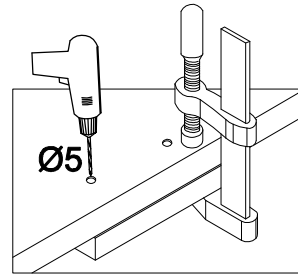
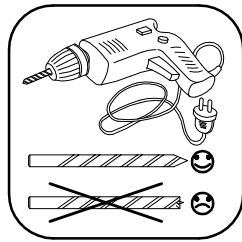
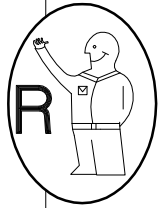
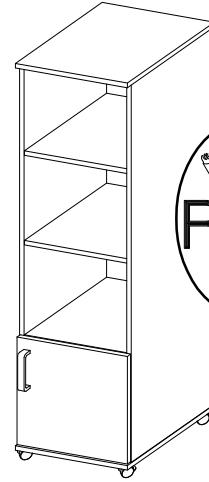
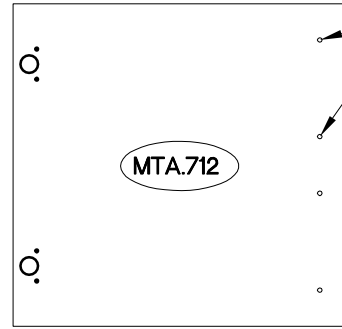
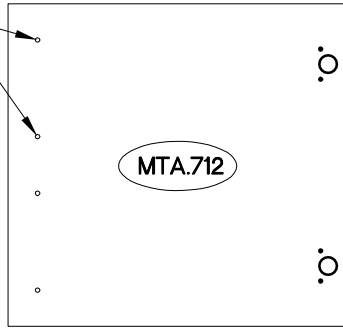
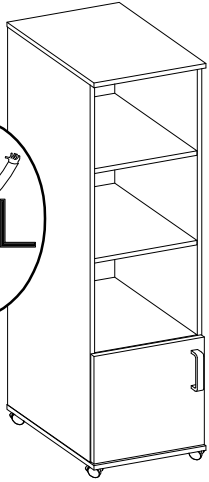
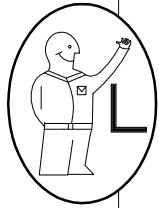

 †35/0mm [CD] HG	 †3.5x13mm P5
2	4



L=128mm	M4x22mm
	
S	U
1	2

