

<b>+8x30mm</b>
<b>A</b>
<b>16</b>

<b>+15/12mm</b>	<b>L=20mm</b>
<b>C</b>	<b>D2</b>
<b>12</b>	<b>12</b>

<b>+20</b>
<b>E11</b>
<b>8</b>

<b>6.5x48x16</b>
<b>F2</b>
<b>4</b>

<b>+5/16mm</b>
<b>J3</b>
<b>12</b>

<b>L</b>
<b>16</b>

<b>L9</b>
<b>1</b>

<b>+5</b>
<b>M10</b>
<b>2</b>



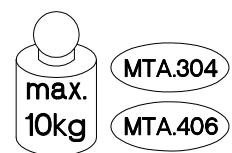
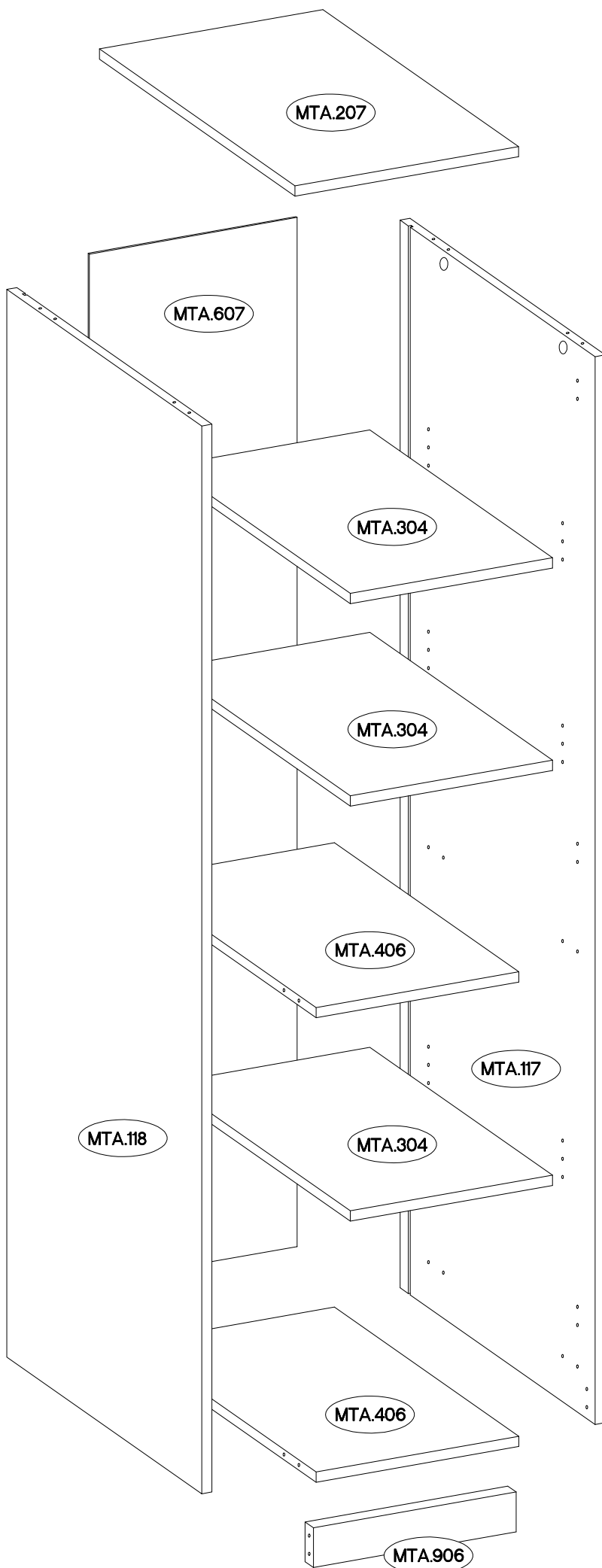

<b>+10x50mm</b>
<b>O7</b>
<b>1</b>

<b>+3.5x13mm</b>
<b>P5</b>
<b>1</b>

<b>+3.0x20mm</b>
<b>P7</b>
<b>6</b>



MTA.117	1878x419x18
MTA.118	1878x419x18
MTA.207	399x420x18
MTA.304 x3	361x392x18
MTA.406 x2	362x396x18
MTA.607	1810x371x2,5
MTA.906	362x70x18

$\varnothing 8 \times 30 \text{mm}$  A 16	$6.5 \times 48 \times 16$  F2 4	$L=20 \text{mm}$  D2 12	$\varnothing 15 / 12 \text{mm}$  C 12
--	--	--	--

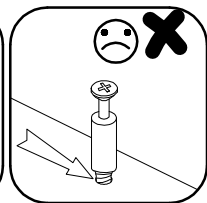
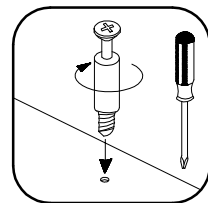
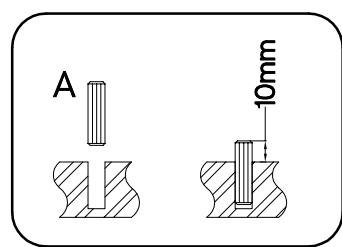
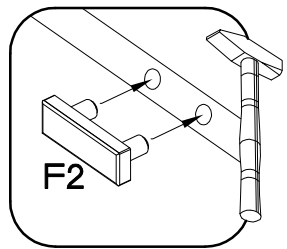
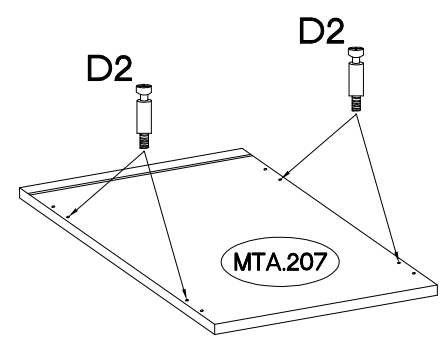
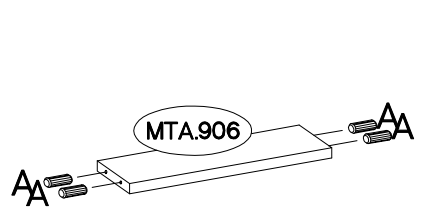
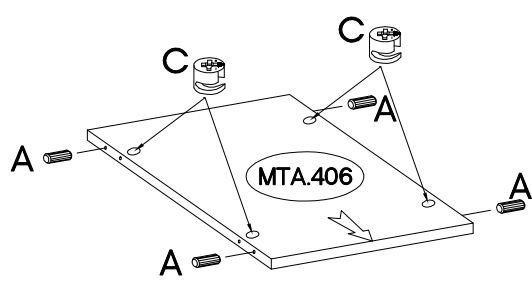
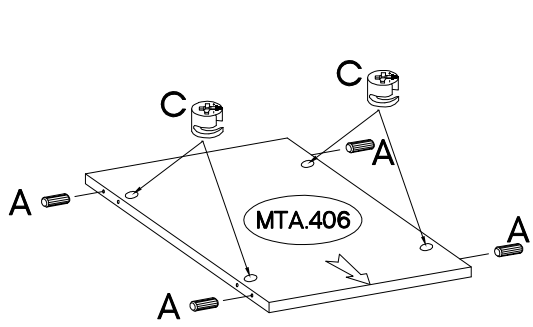
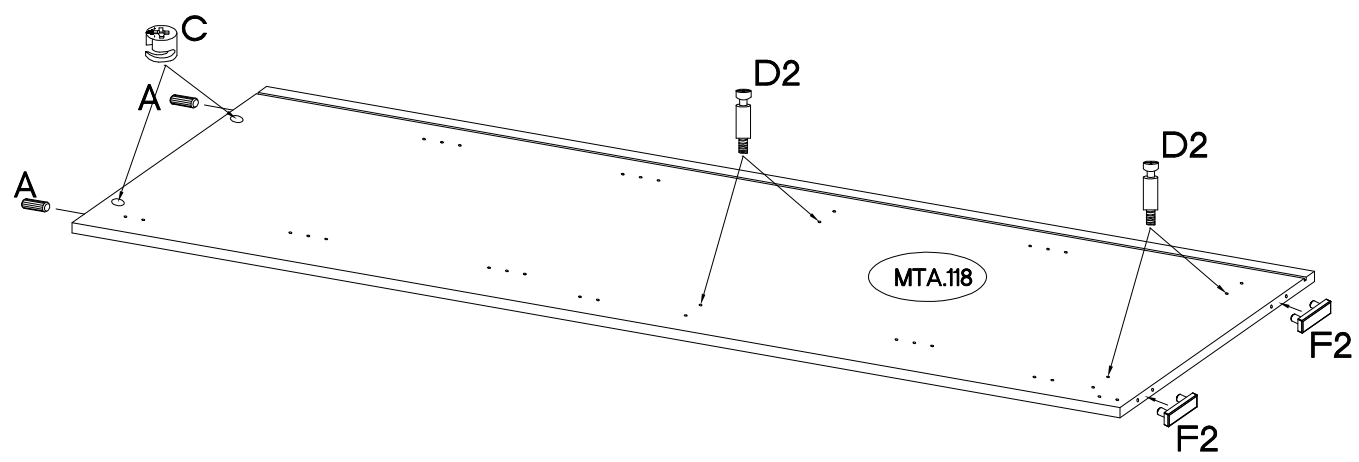
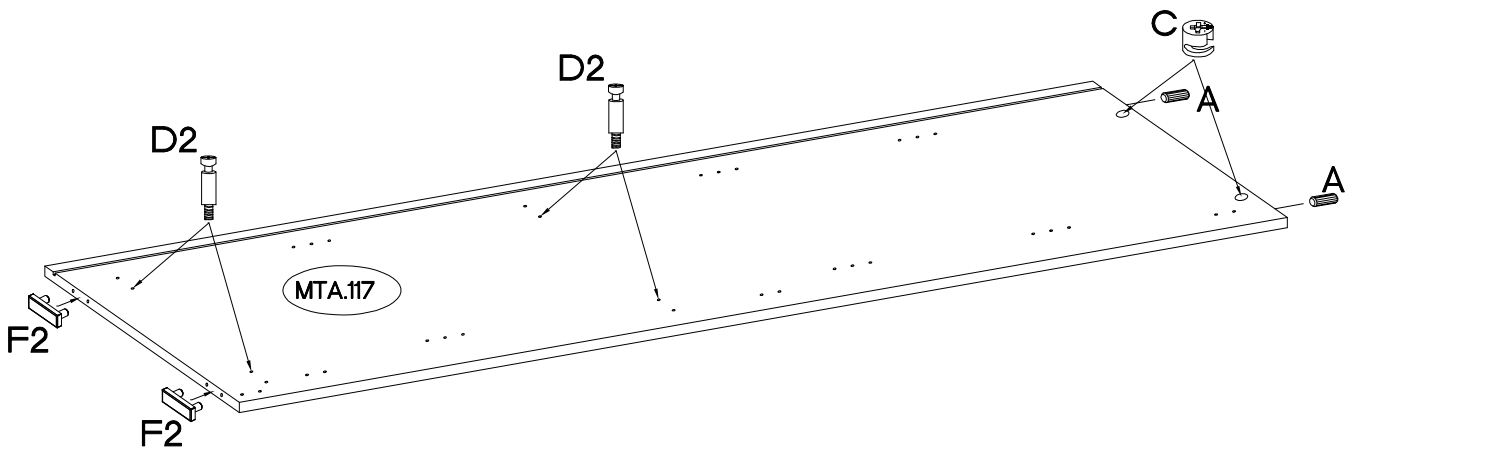
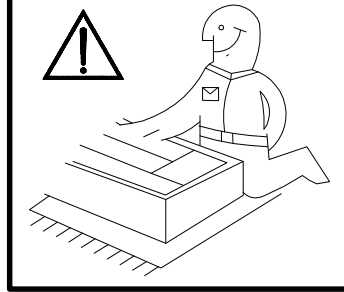
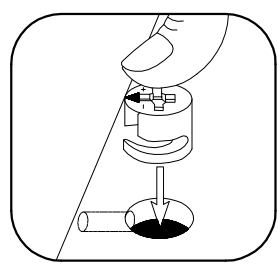

2

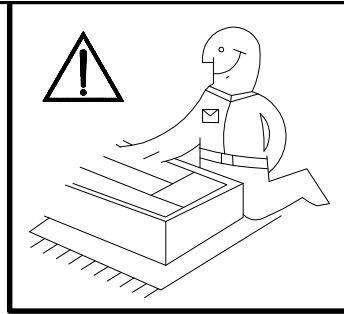
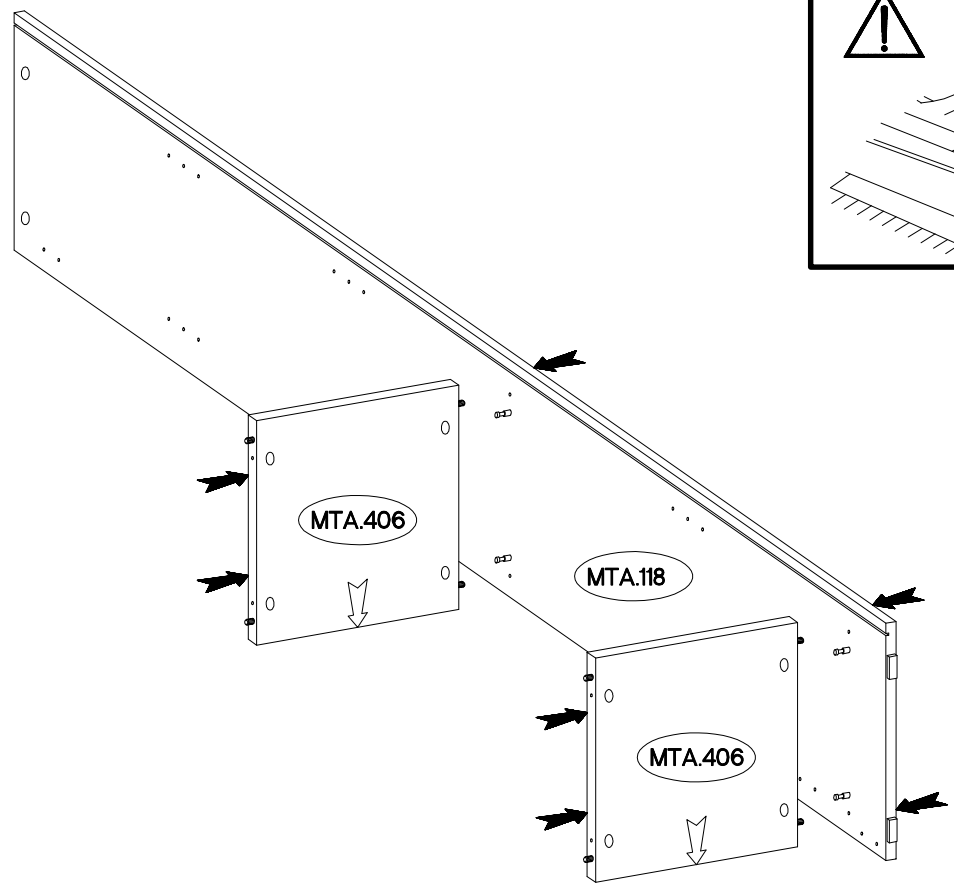

3

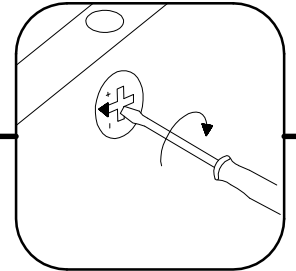
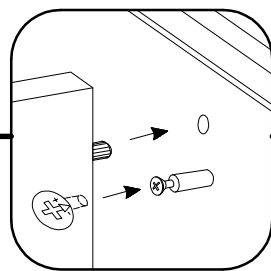
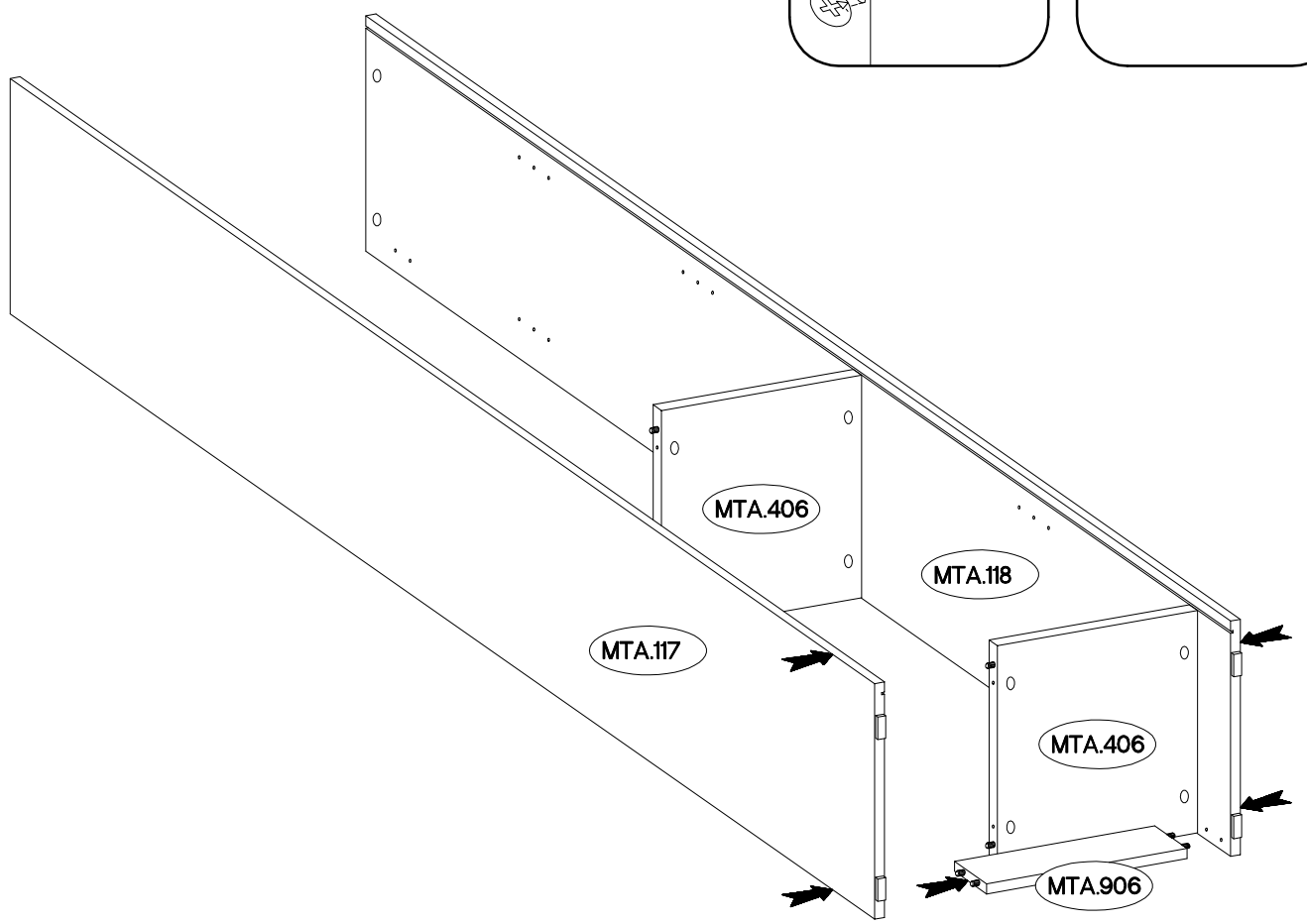

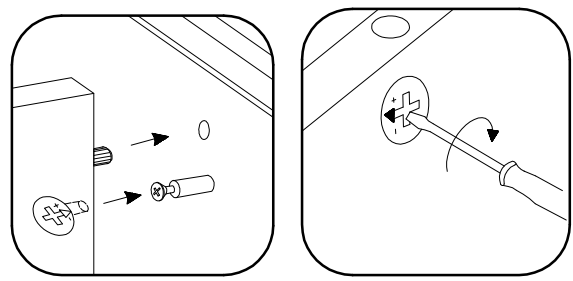
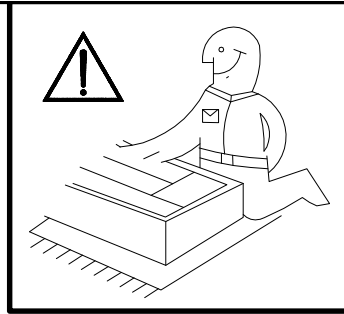
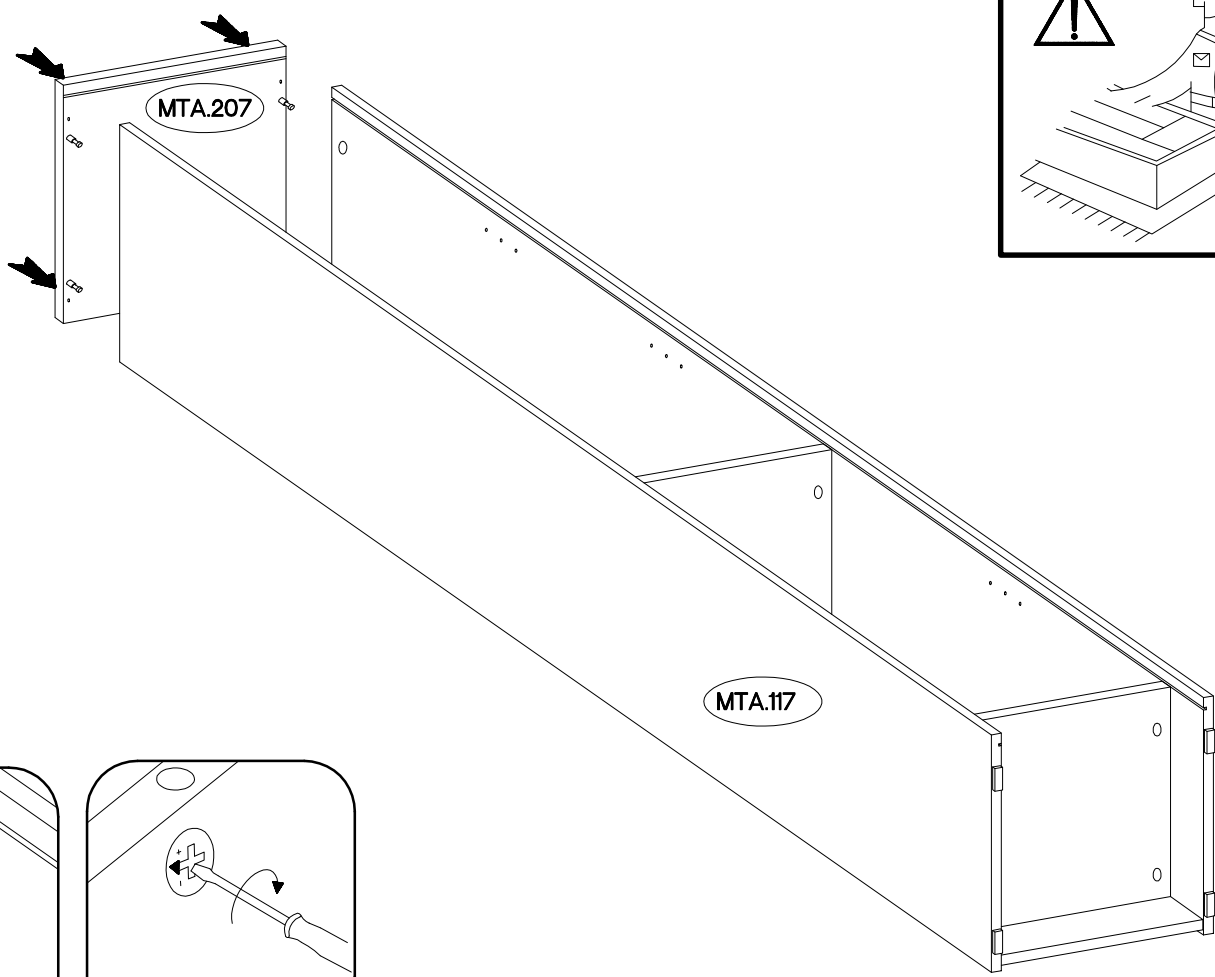

4



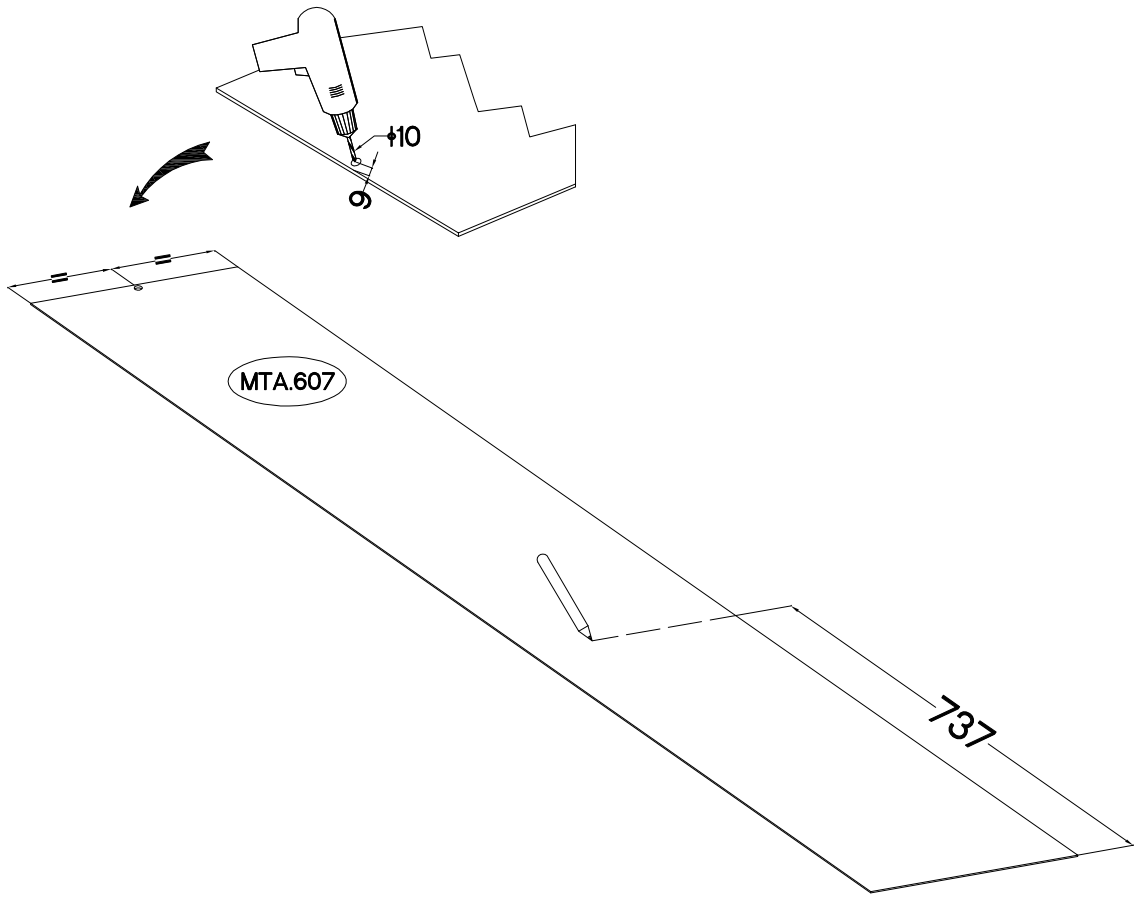

5



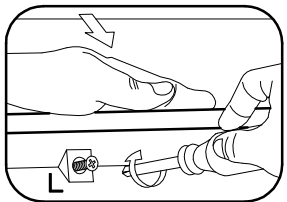
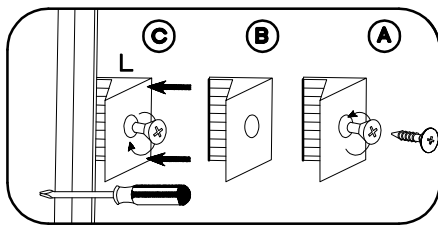
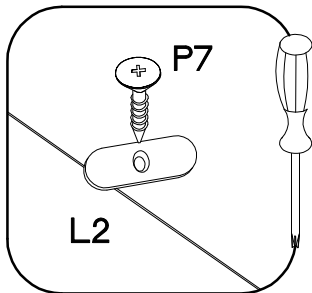
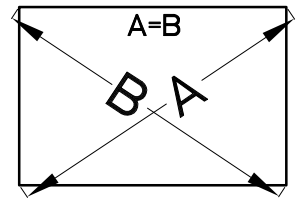
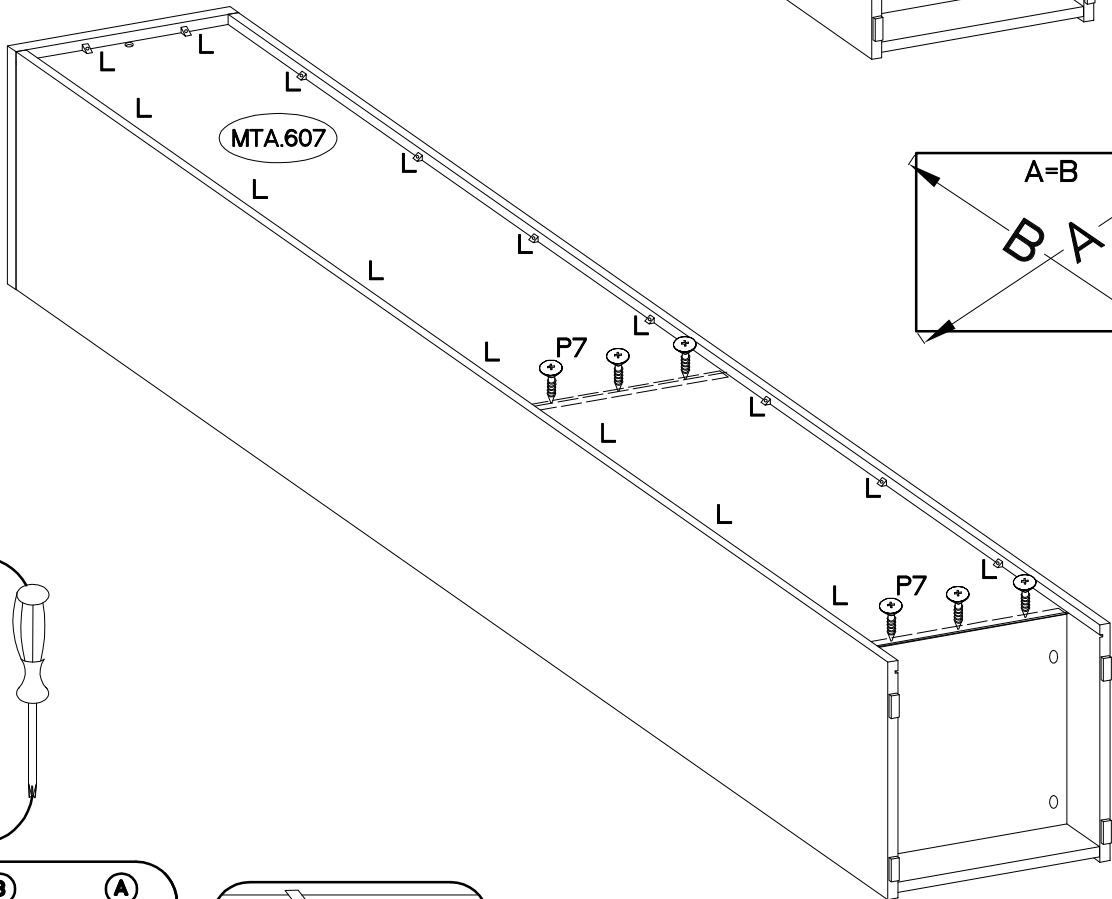
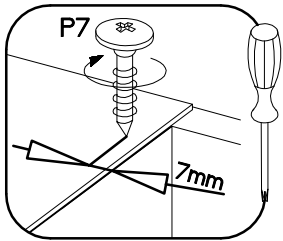
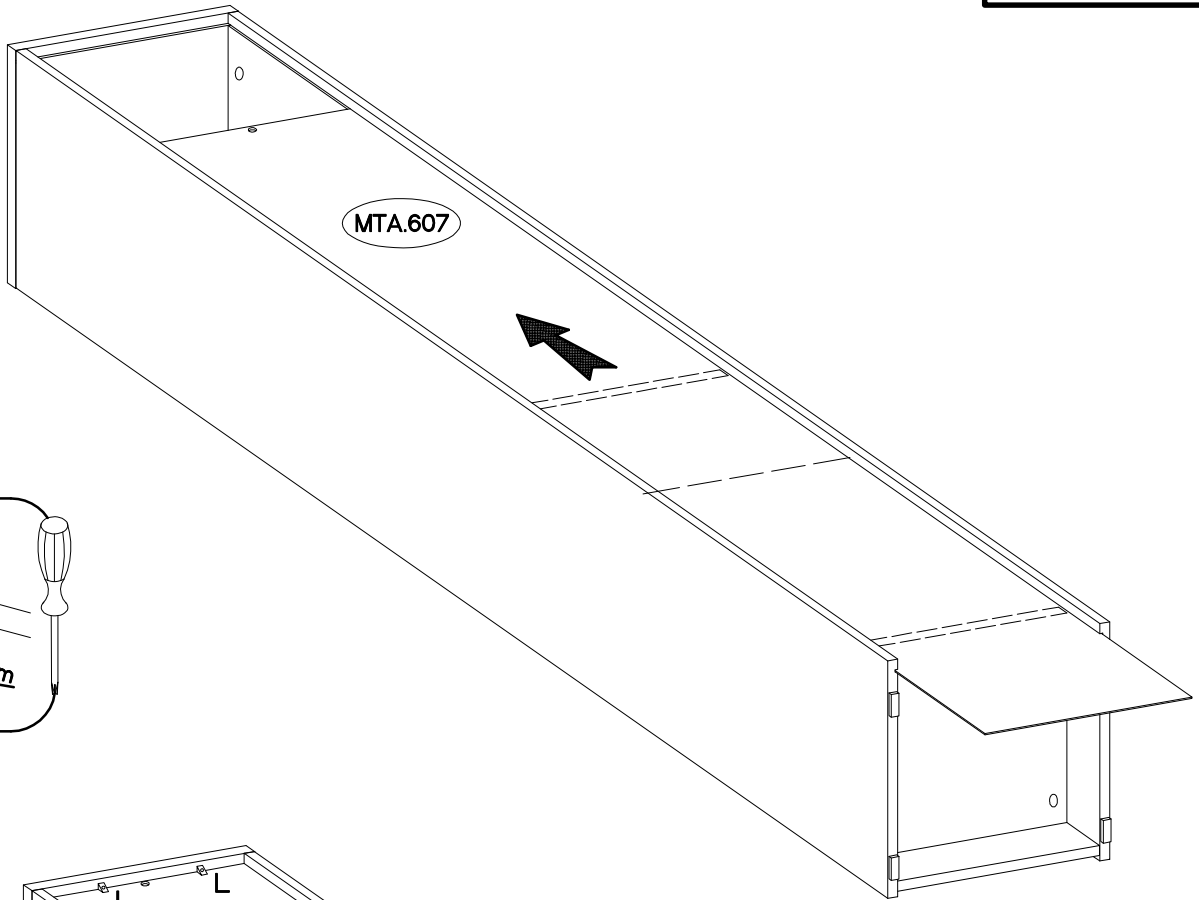
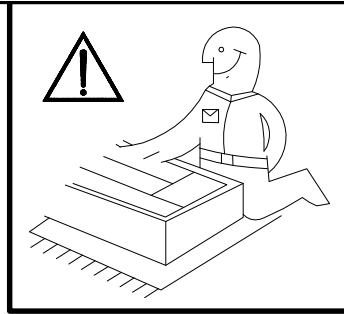

<p>±3.0x20mm</p>  <p>P7</p> <p>6</p>	 <p>L</p> <p>16</p>
---	---

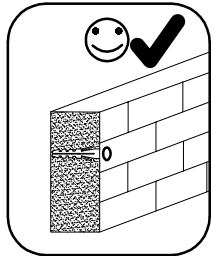
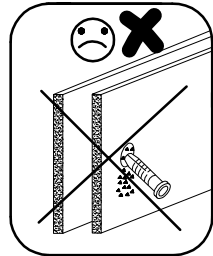
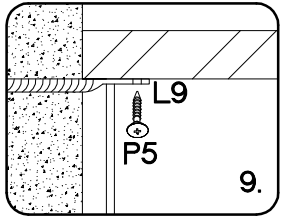
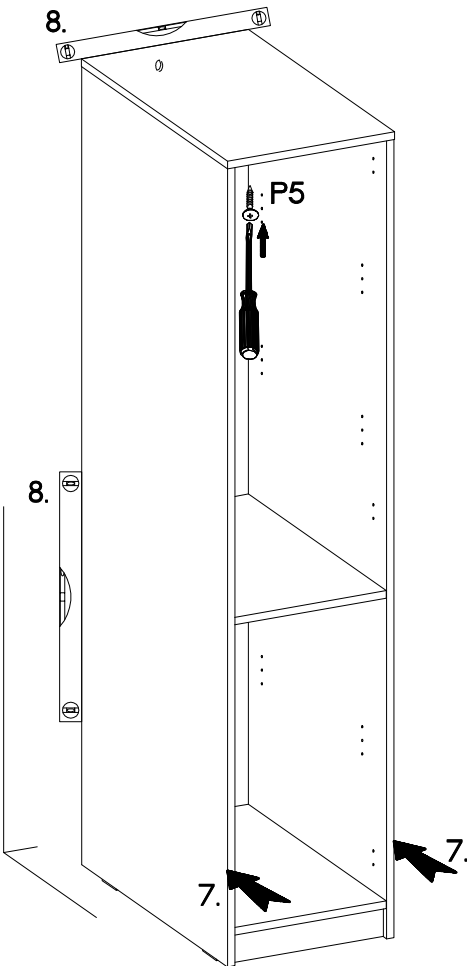
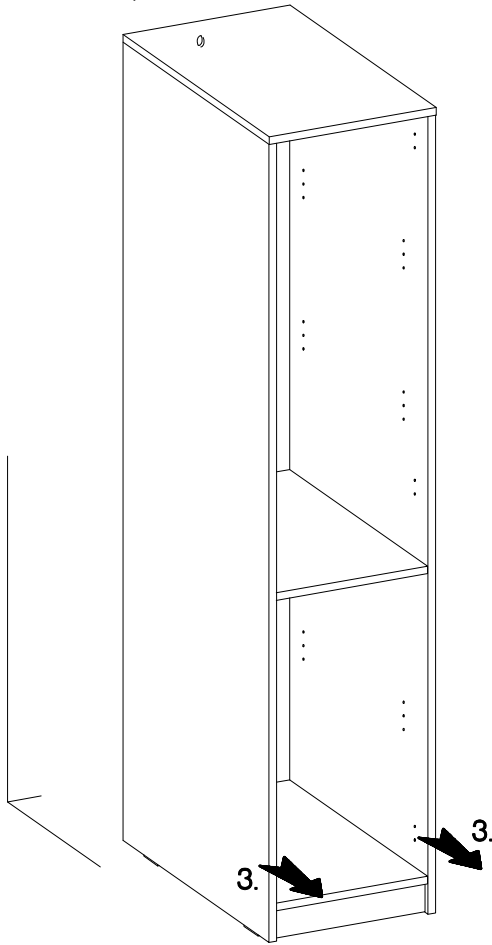
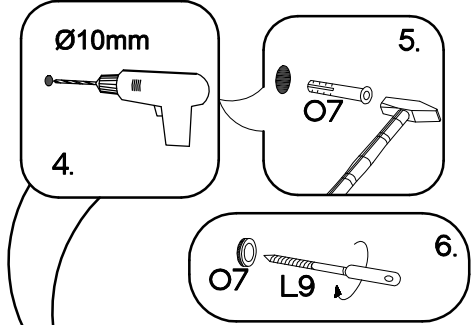
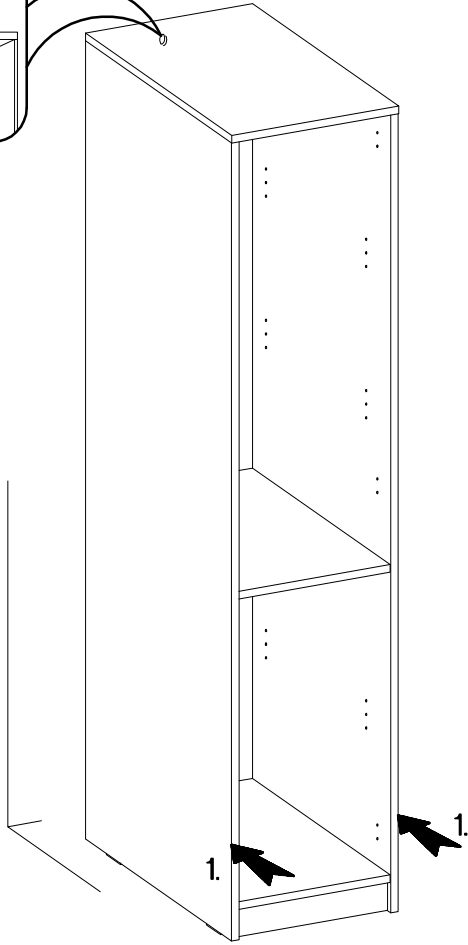
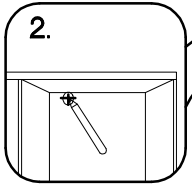

# 7

$\pm 10 \times 50 \text{mm}$ 	$\pm 3.5 \times 13 \text{mm}$ 	$\pm 3.5 \times 13 \text{mm}$ 
O7	L9	P5
1	1	1



$\pm 5/16\text{mm}$  J3 12	$\pm 20$  E11 8
---	--

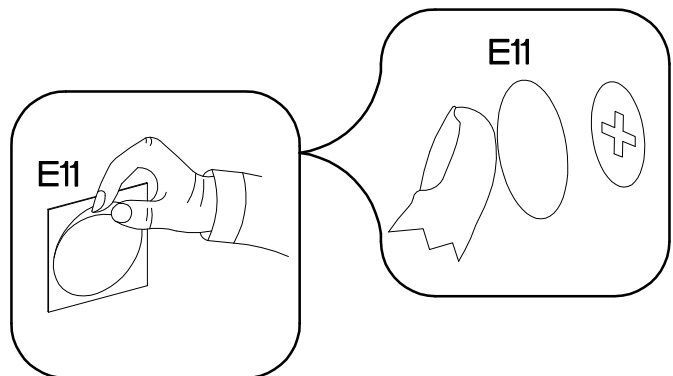
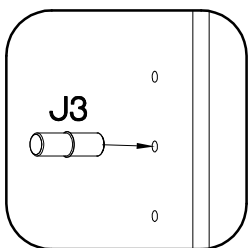
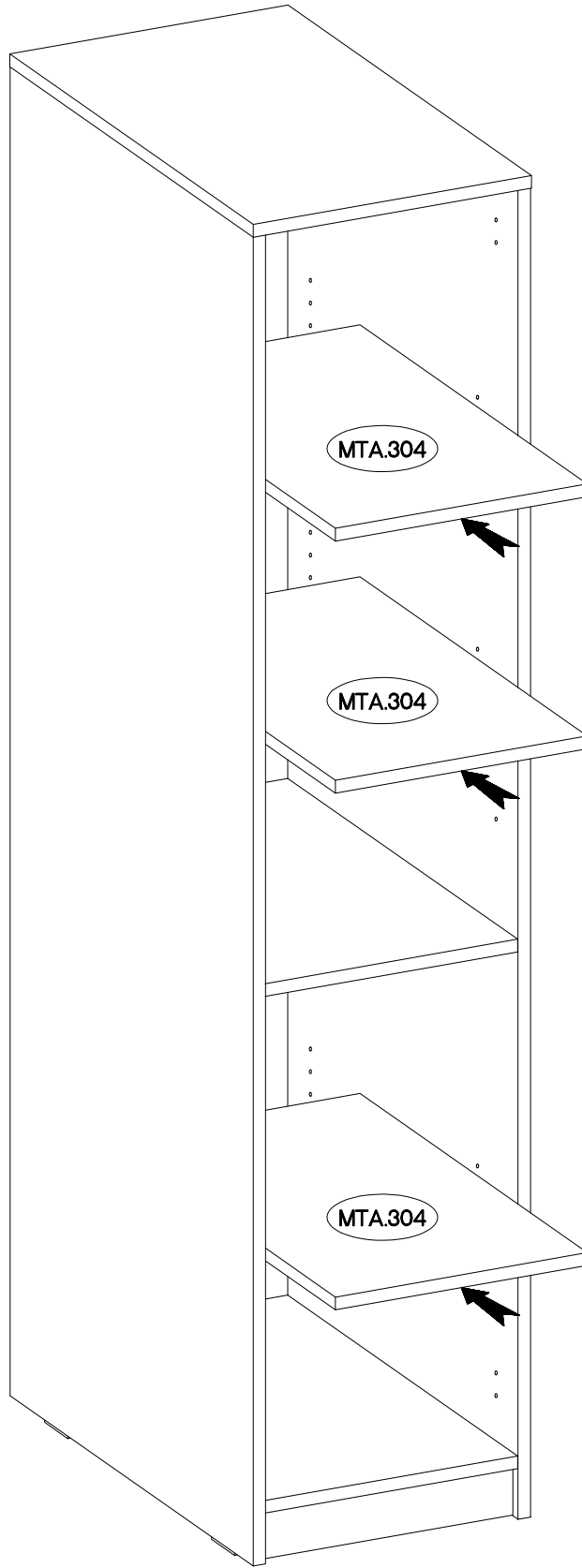



9

