

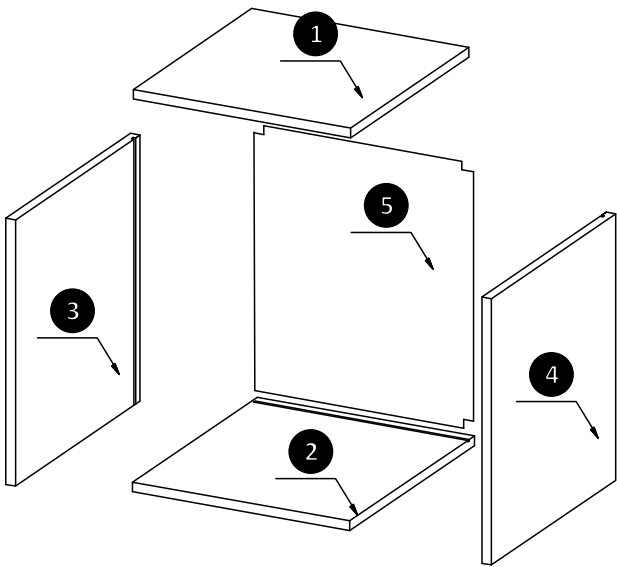

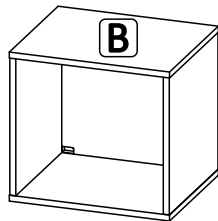

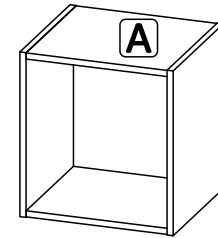



# E10



1	1	368	359	16
2	1	368	359	16
3	1	430	360	16
4	1	430	360	16
5	1	406	378	3



<b>A0</b>  8x30 8	<b>C0</b>  8	<b>C2</b>  8	<b>C7</b>  8	<b>D0</b>  3x15 4	<b>D13</b>  4x30 4	<b>M1</b>  4	<b>P4</b>  2
--	---	---	---	---	--	---	---

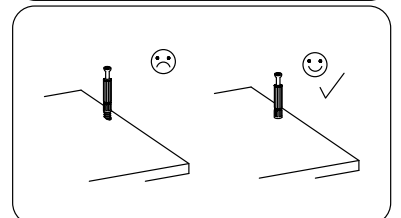
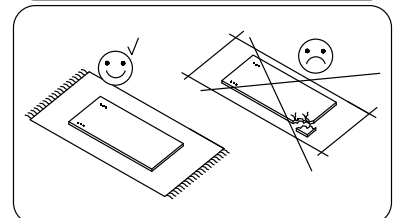
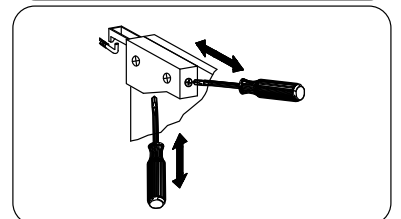
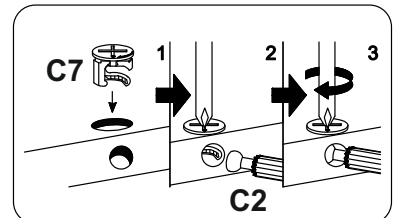
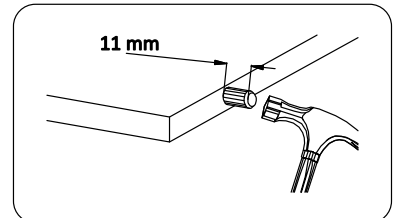
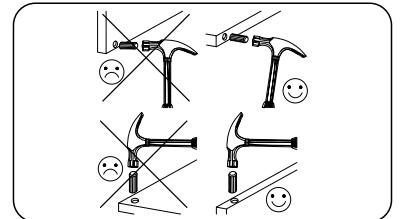
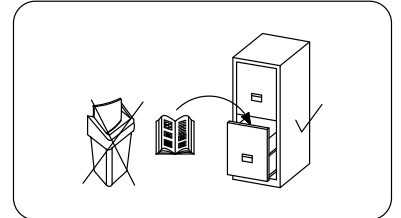
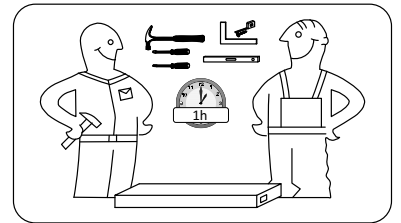

**A**

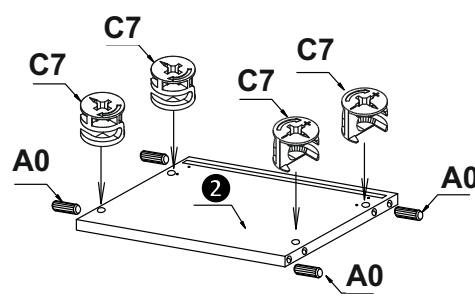
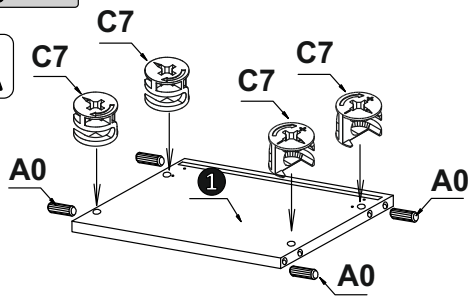

**A**

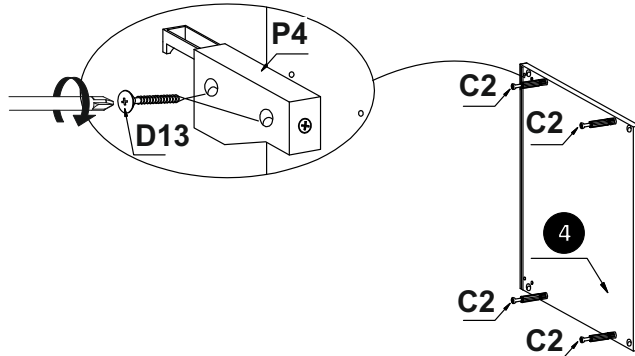
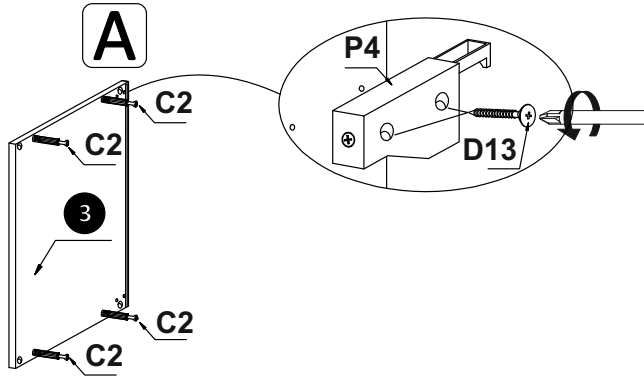

**A**

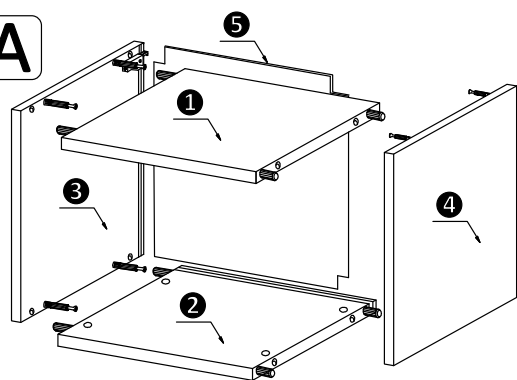

**B**

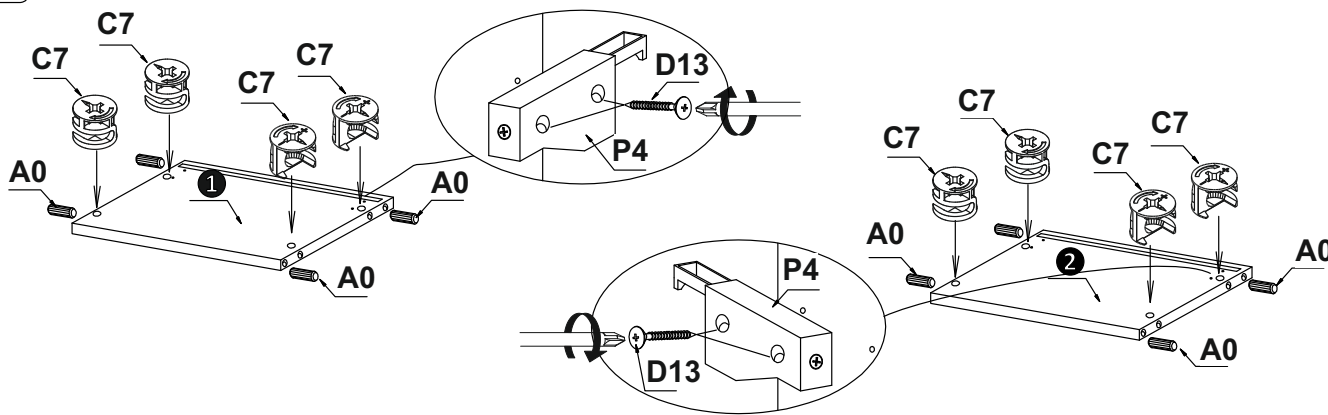

**B**

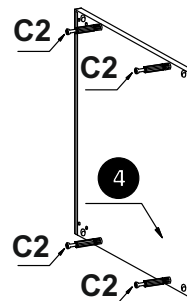
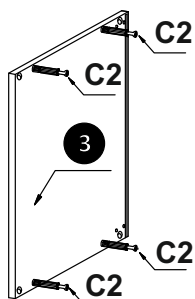

B

