

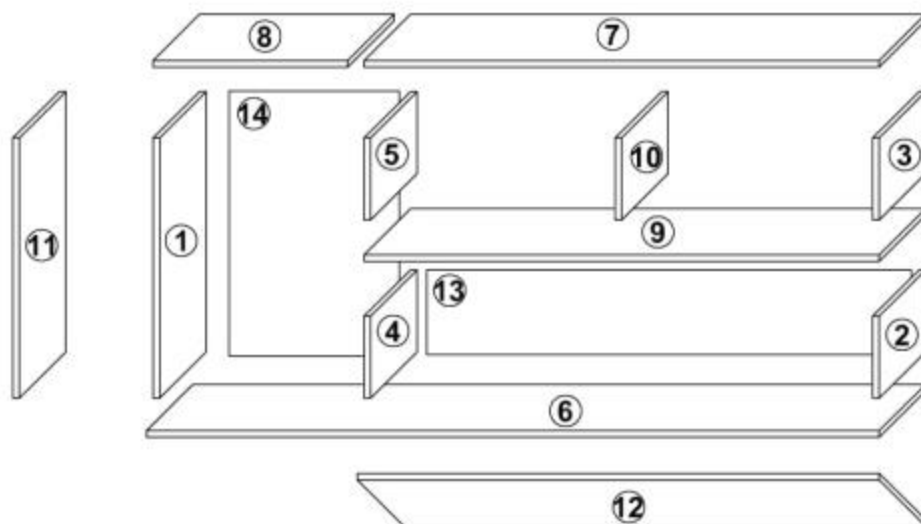

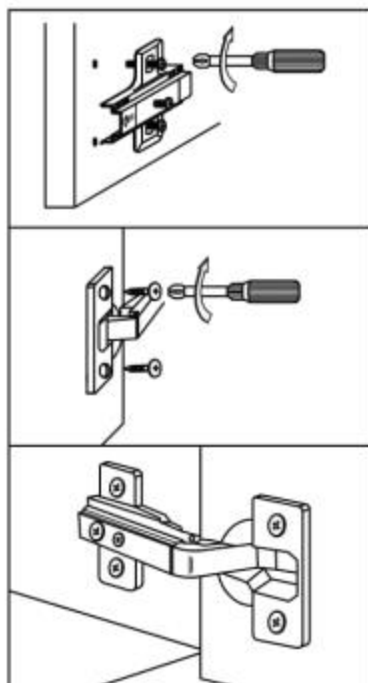

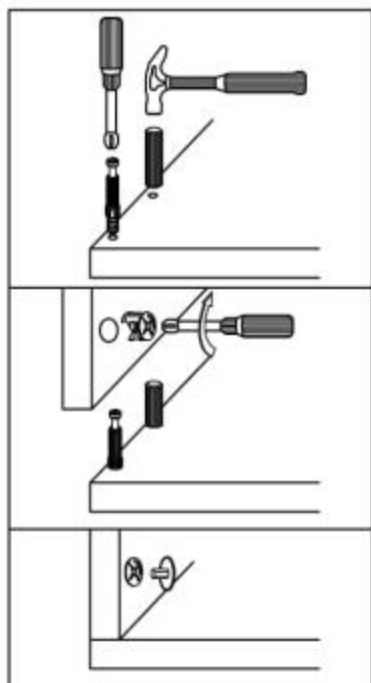

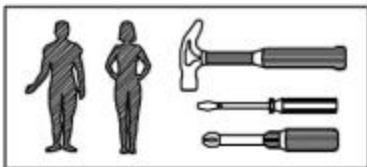









KF50	KZ	8x45	ZMS	W5x10	K8x40
4	1	4	2	4	2



								
TM	MM	ZMB	ZMC	L-68	L-76	8x45	8x30	ZR
16	28	14	14	2	4	6	16	4
								
PZ	W4x16	SW	W4x20	G2	U1	W4x16		
4	8	6	6	25	2	4		

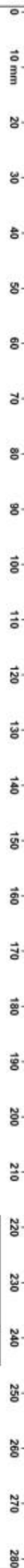
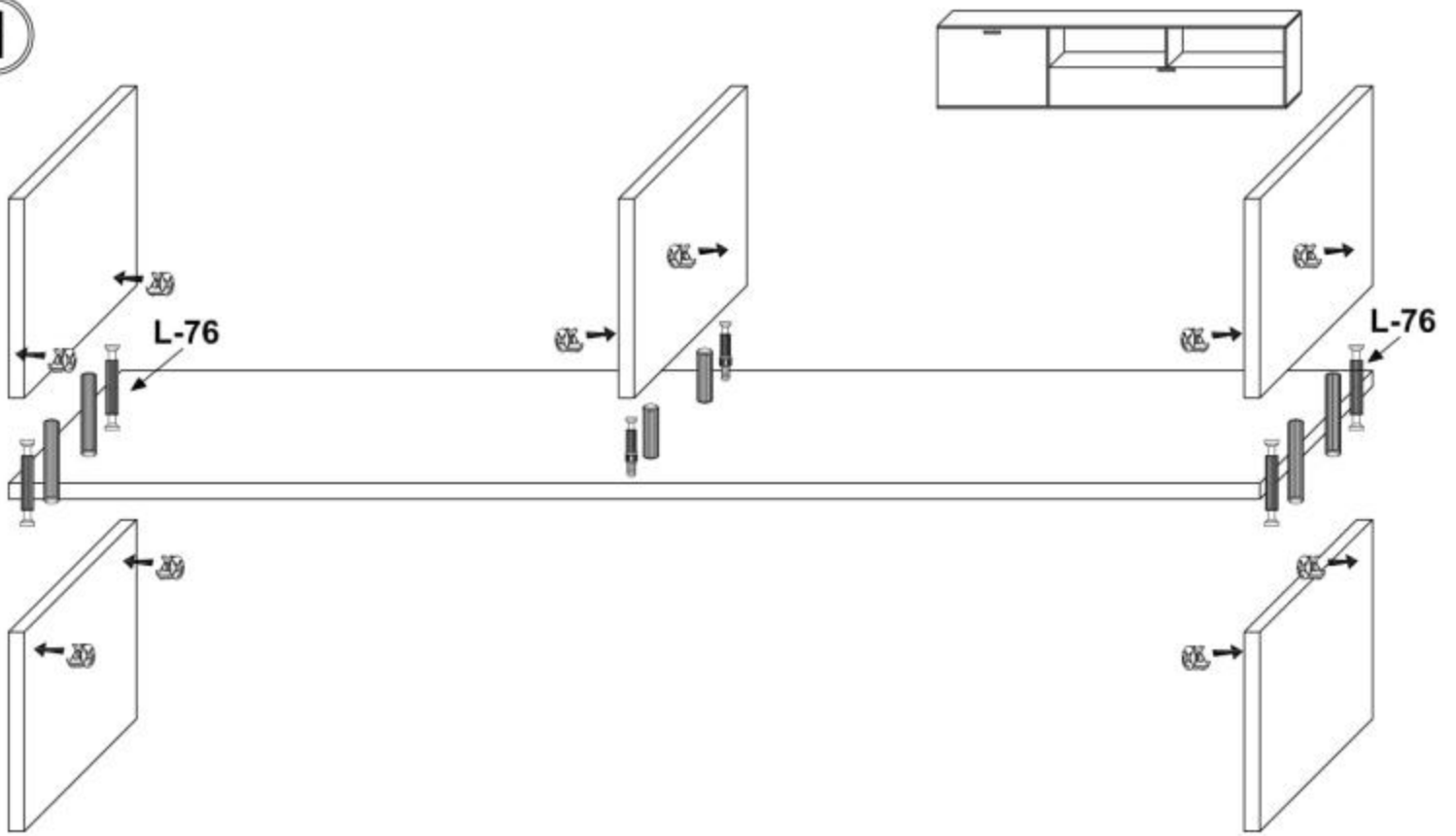

1



2

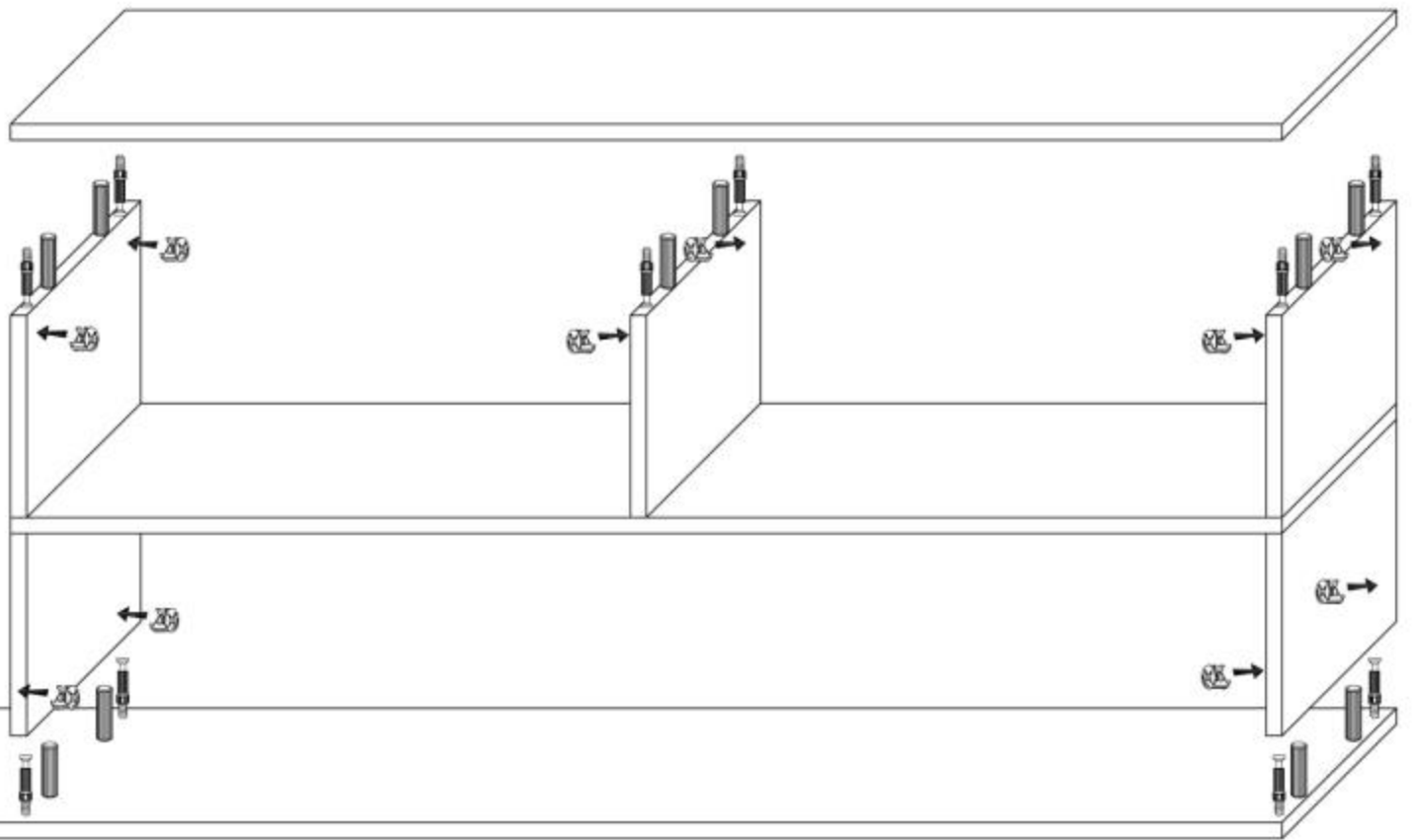

3

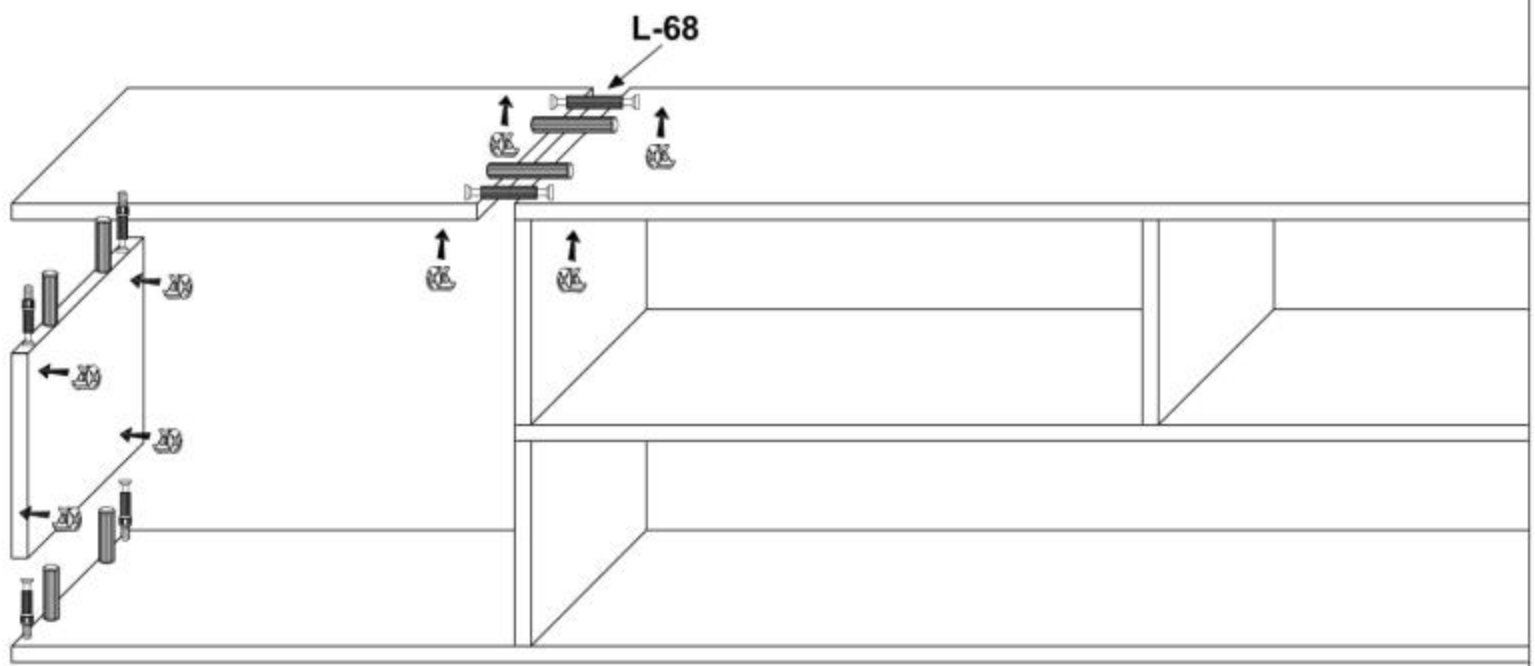



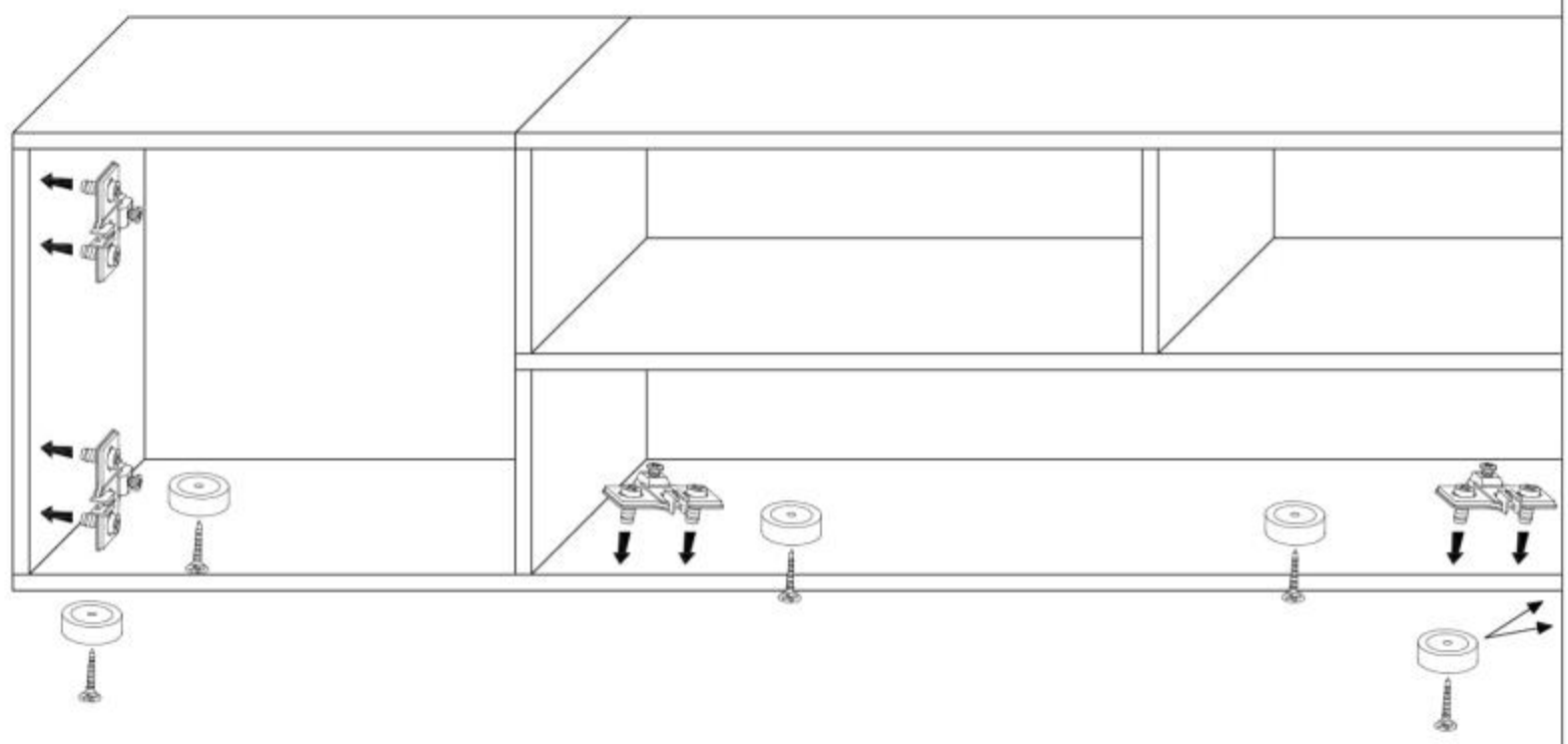

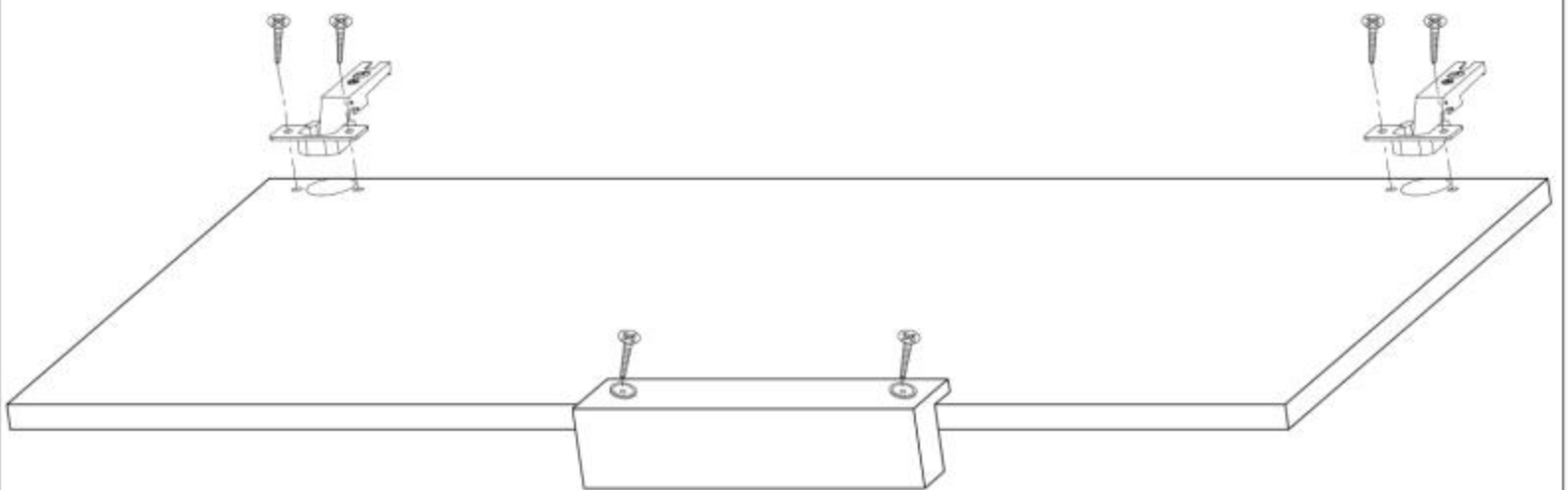
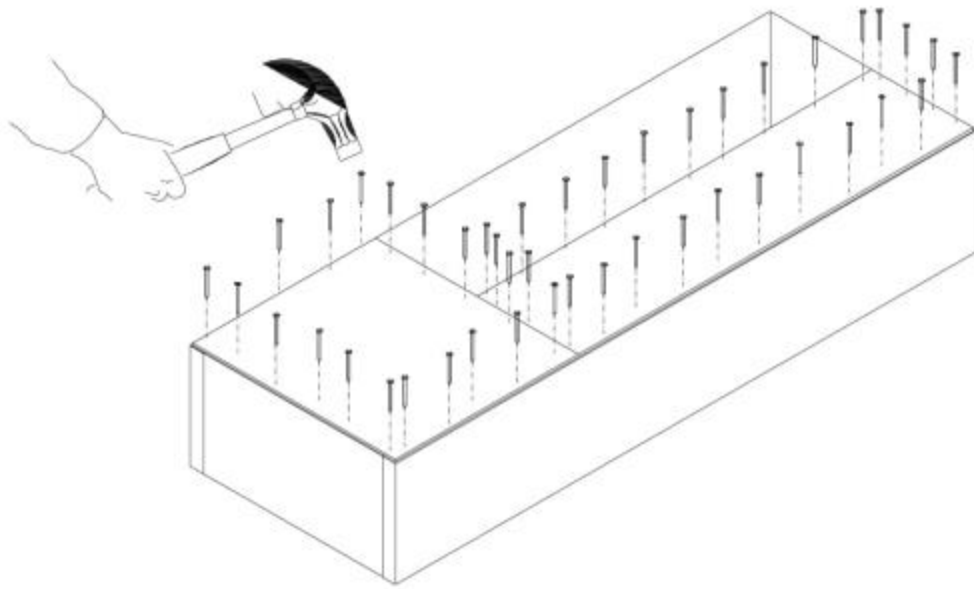

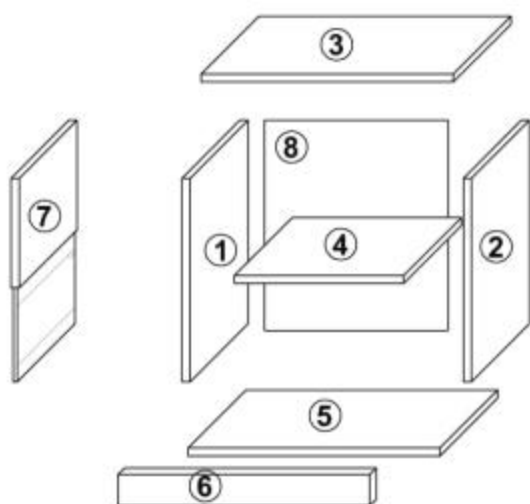
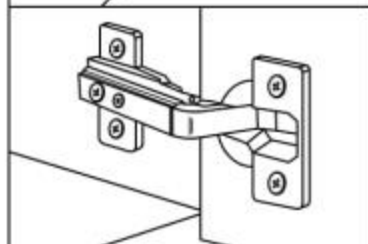
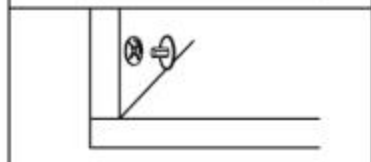
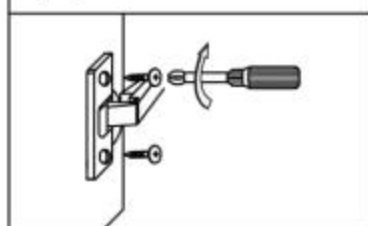
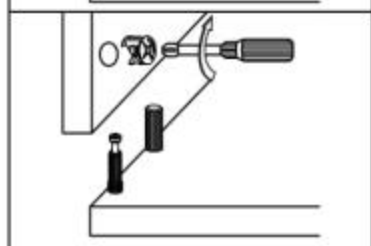
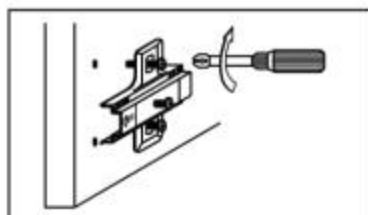
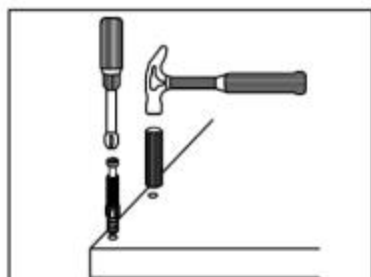
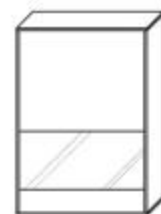
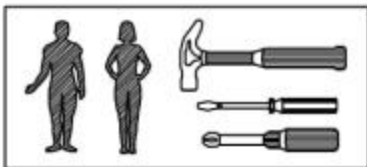







3







								
TM	MM	ZM	8x30	ZR	PZ	W4x16	ODB	W3x16
14	14	14	10	2	2	4	1	2
								
ZA	W4x30	K10x50	STB	KLEJ				
2	4	4	6	1				

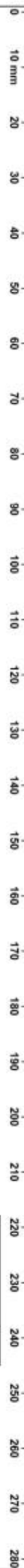

1

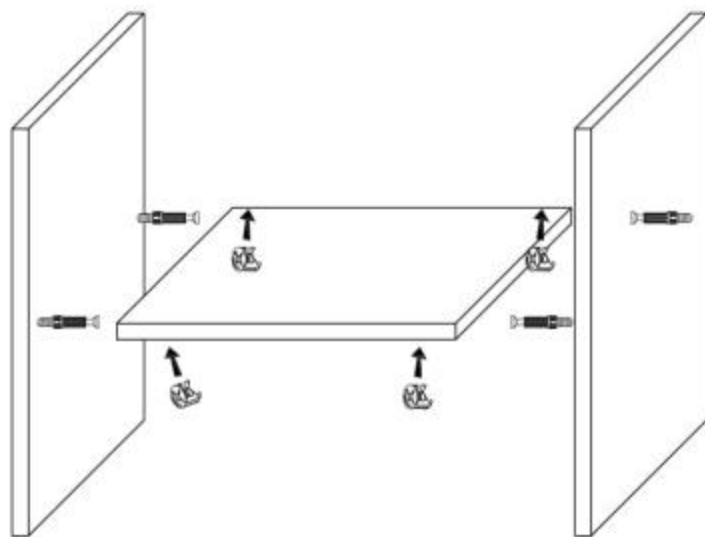

2

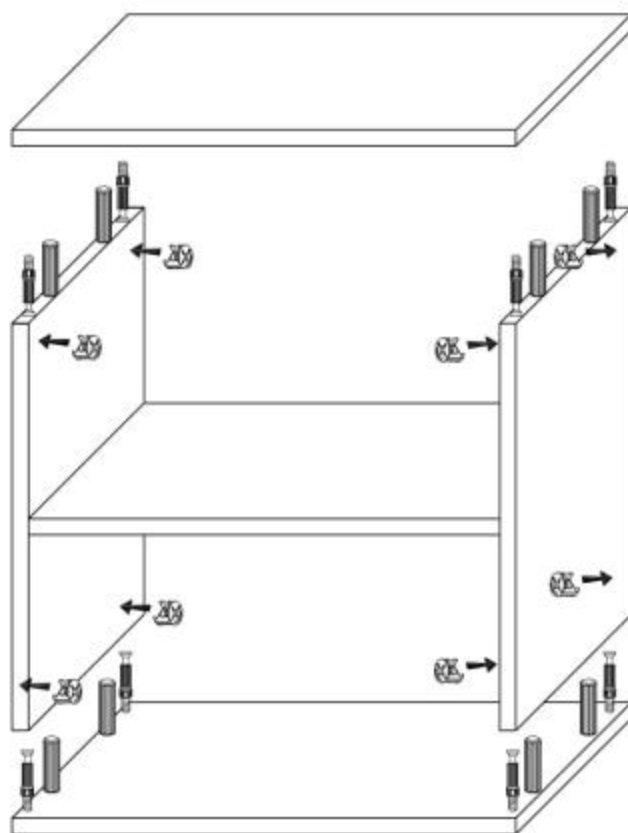

3

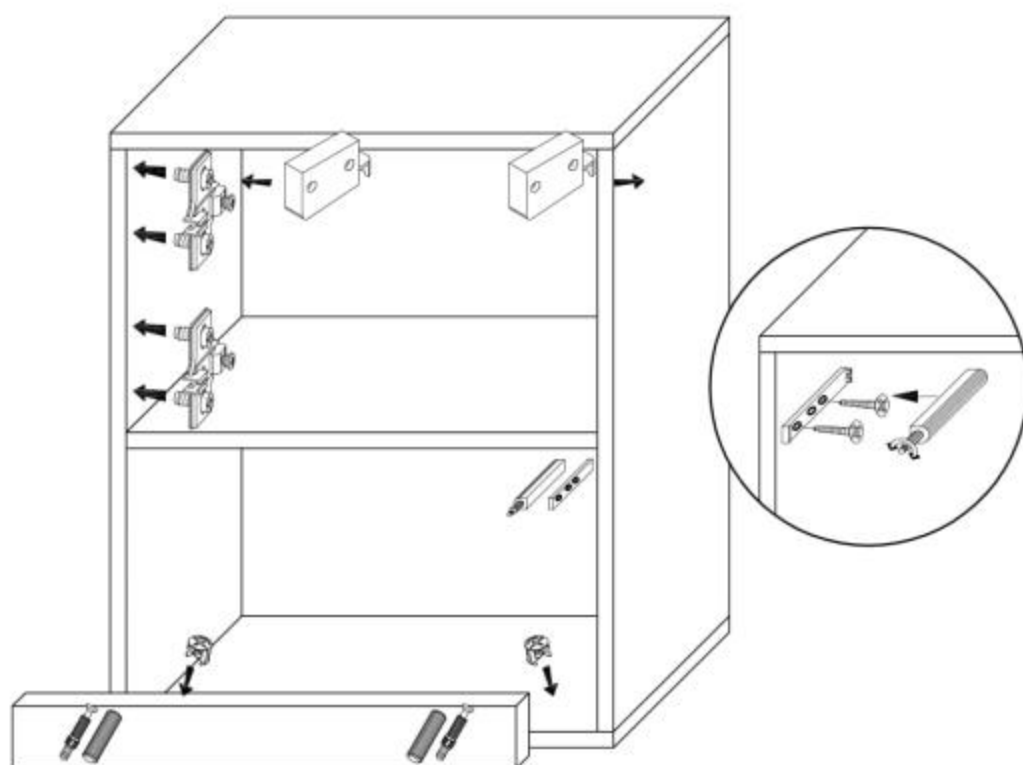

4

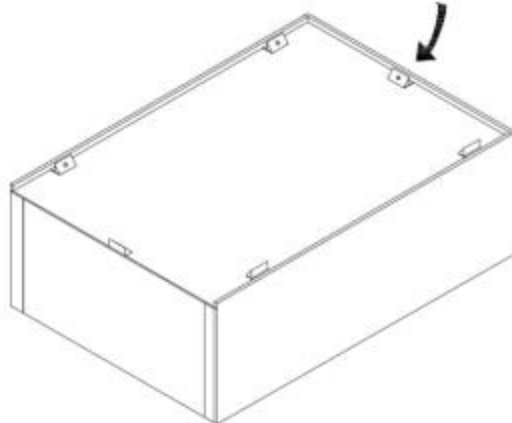
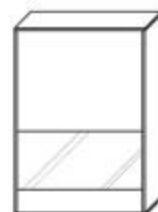
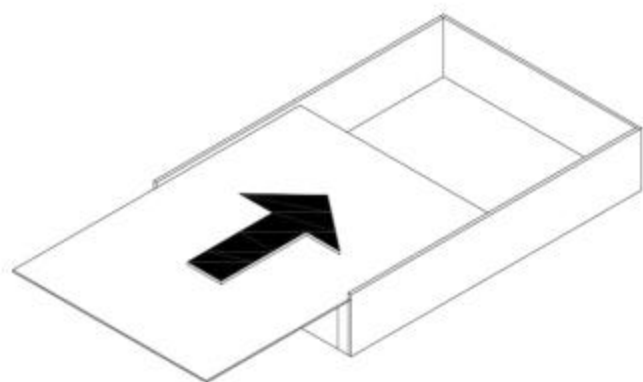

5

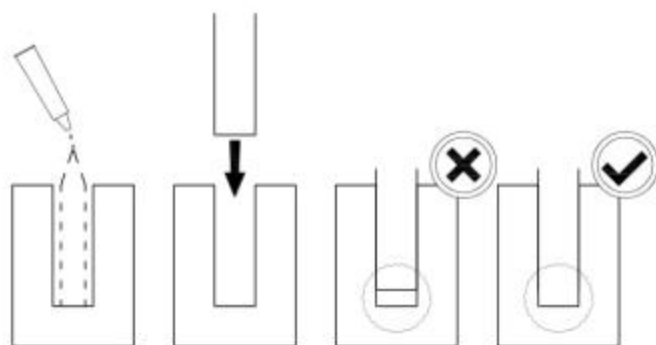
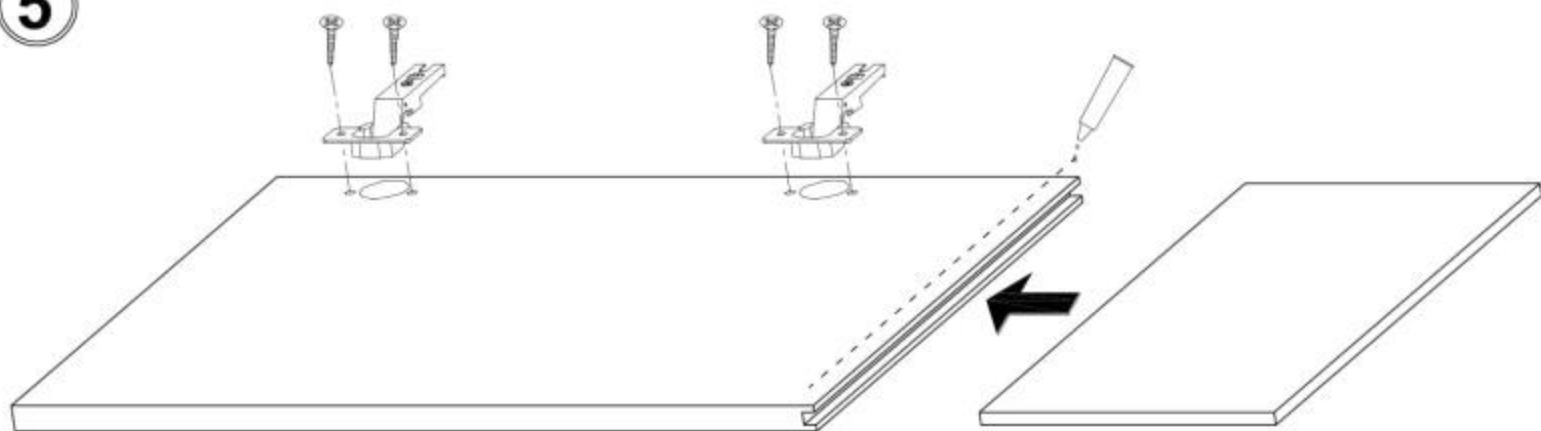

240 min