

**K-80D2SZ1**

**800 X 990 X 400 MM**

**05 - 2016**

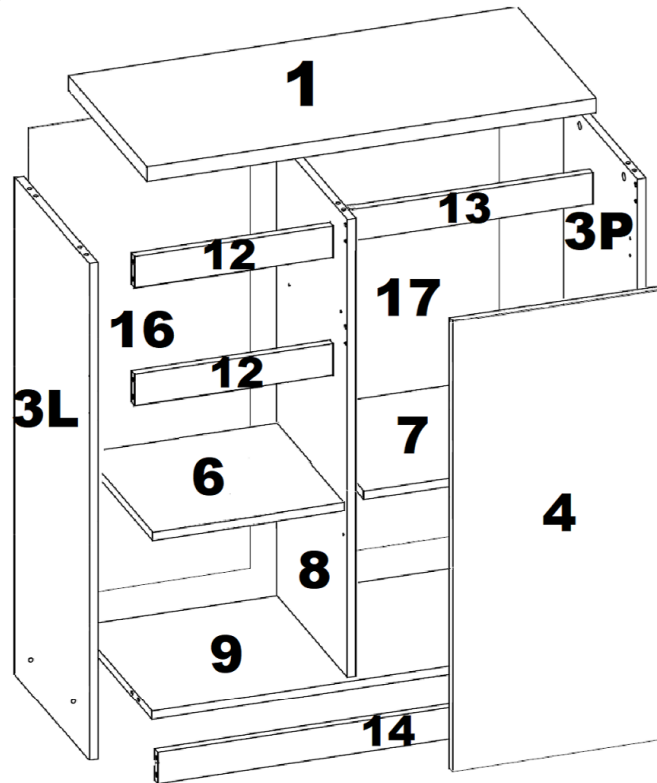
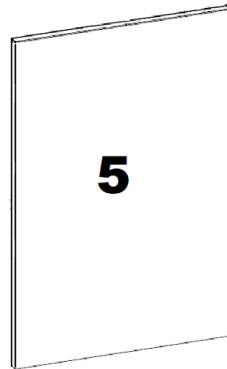
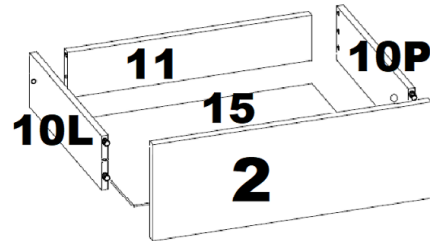
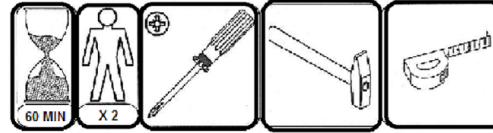

	x1
<b>T3</b>	
	x8
<b>KF</b>	
	x36
<b>A1</b>	
	x4
<b>C2</b>	
	x14
<b>N1</b>	
	x60
<b>G</b>	
	x1
	x4
<b>O2</b>	
	x8
<b>F1</b>	
	x8
<b>E1</b>	
	x8
<b>E0</b>	
	x4
<b>SP</b>	
	x8
<b>D2</b>	
	x4
<b>ZN</b>	
	x8
<b>Euro 6,5x13</b>	

# K-80D2SZ1

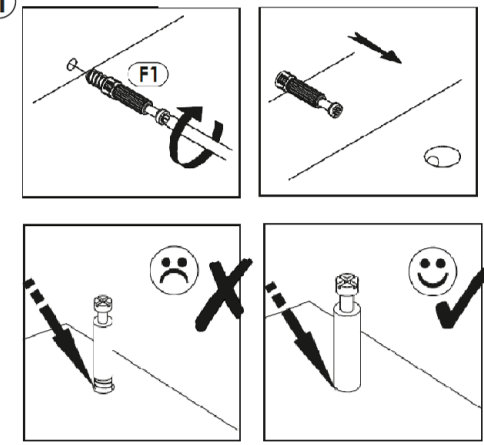
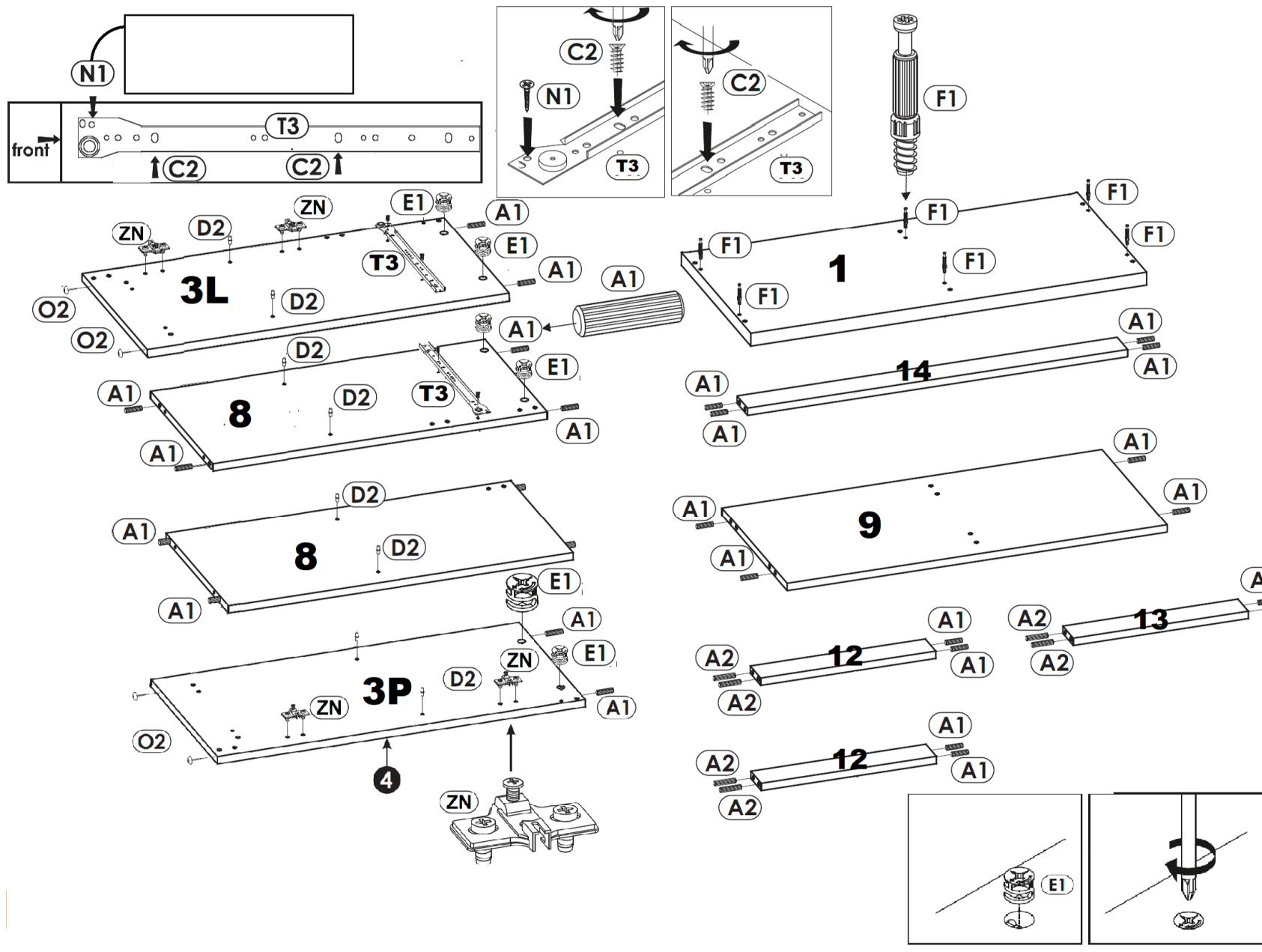

# K-80D2SZ1 800 X 990 X 400 MM

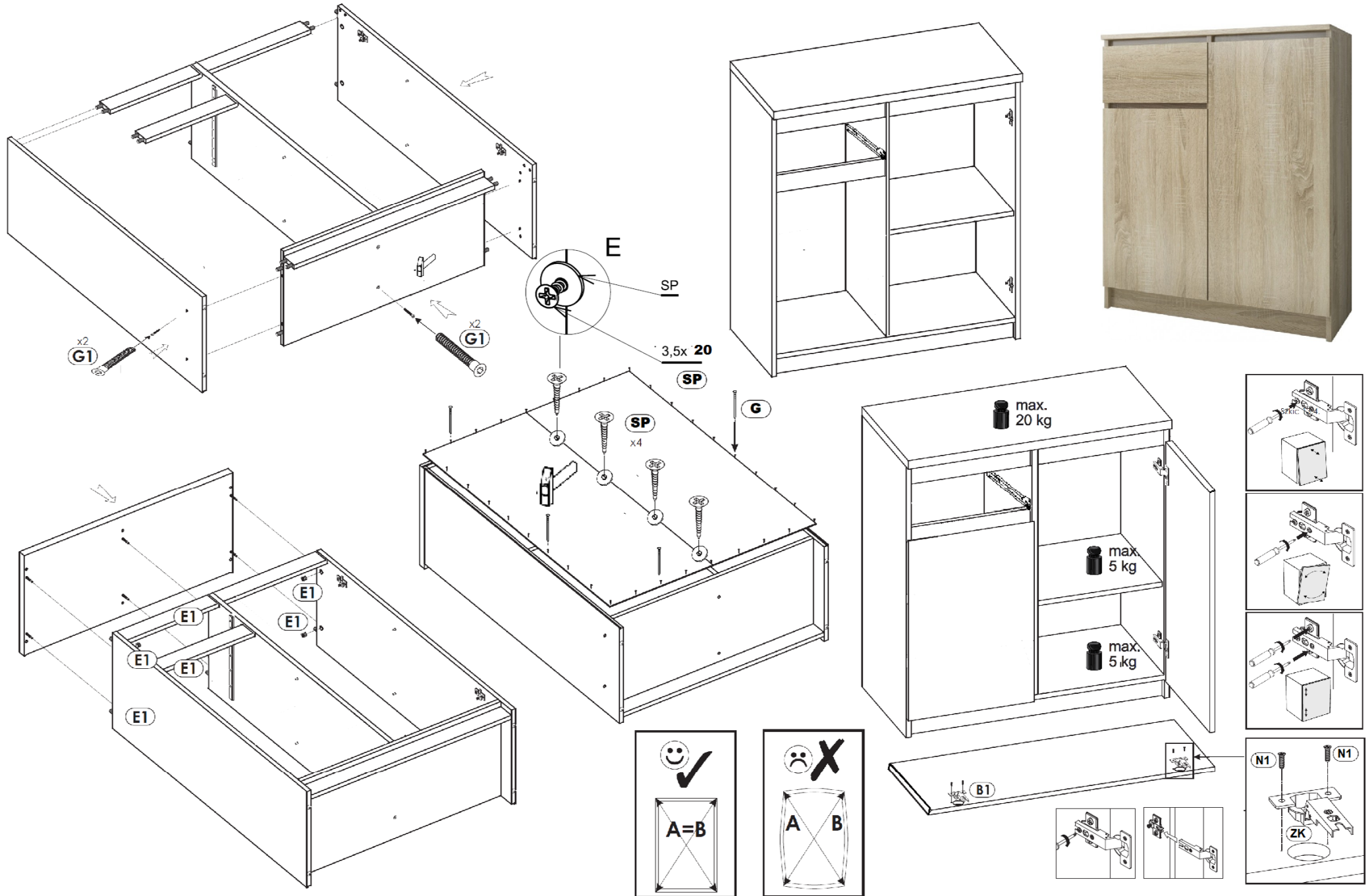

# K-80D2SZ1 800 X 990 X 400 MM

