

- BJ22-3F
- WH22-3F
- DL22-3F
- SO22-3F
- GRDL22-3F

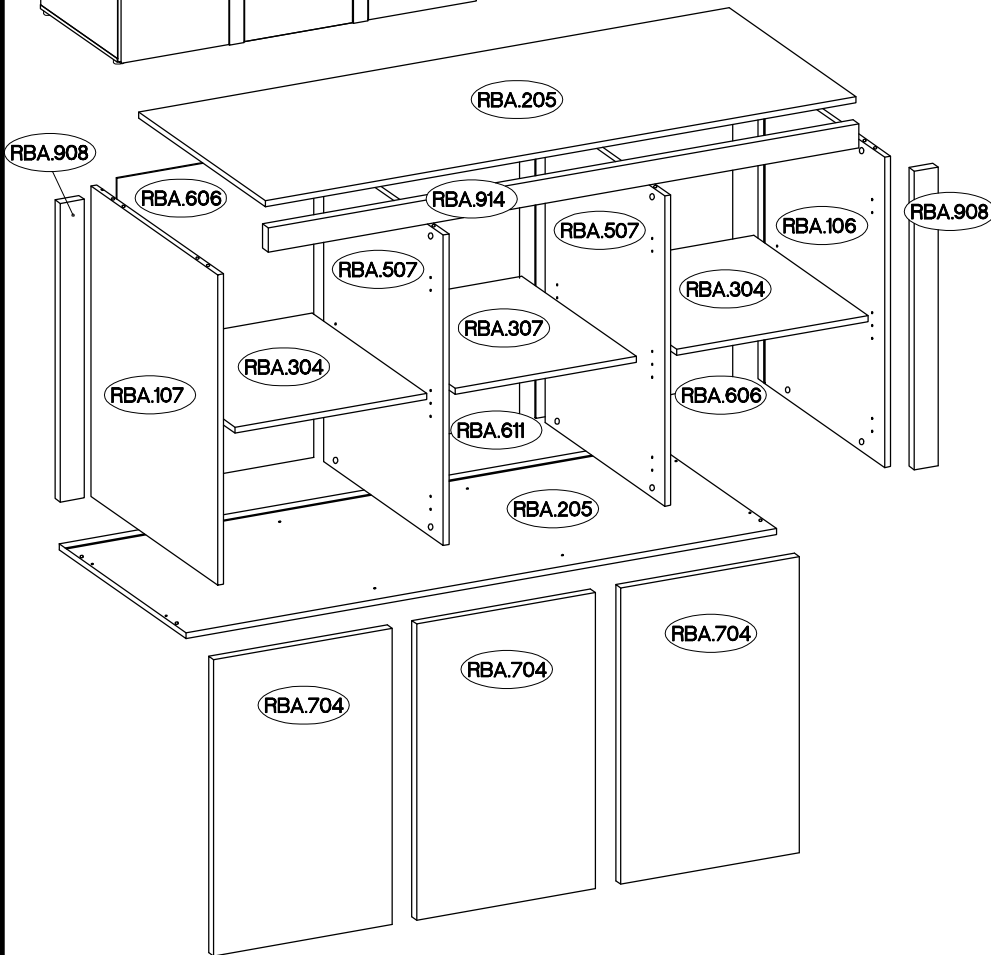

	RBA.106	770x384x15
	RBA.107	770x384x15
	RBA.307	457x347x15
1/2	RBA.606 x2	779x496x2,5
	RBA.611	779x472x2,5
	RBA.704 x3	450x735x15
	RBA.908 x2	741x60x16
2/2	RBA.205 x2	1488x384,5x15
	RBA.304 x2	483x347x15
	RBA.507 x2	770x362x15
	RBA.914	1488x60x18

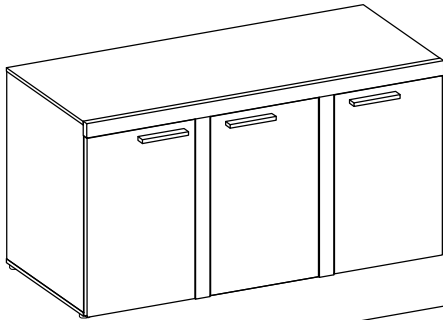
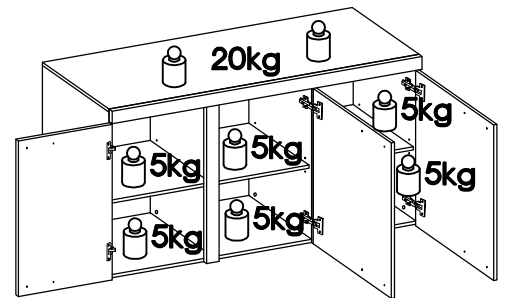

†10x50mm 		†4.0x16mm
O7	L9	P1
2	2	26
†10x50mm 		
P14	T9	T4
6	9	2

L=128mm 	†4.0x30mm 	†5/16mm 	†3.0x20mm 			†60/20mm 	†4.0x25mm
S1	R2	J3	P7	L2	L	F10	P14
3	6	12	10	10	10	6	6
†8x30mm 	L=20mm 	†15/12mm 			†35/0mm 	†35/16mm 	†3.5x13mm
A	D2	C	E	H	G	G2	P5
8	16	16	16	6	4	2	14

1

±8x30mm A	L=20mm D2	±15/12mm C	T9	T4	F10	±4.0x25mm P14	±4.0x16mm P1
8	16	16	9	2	6	6	13

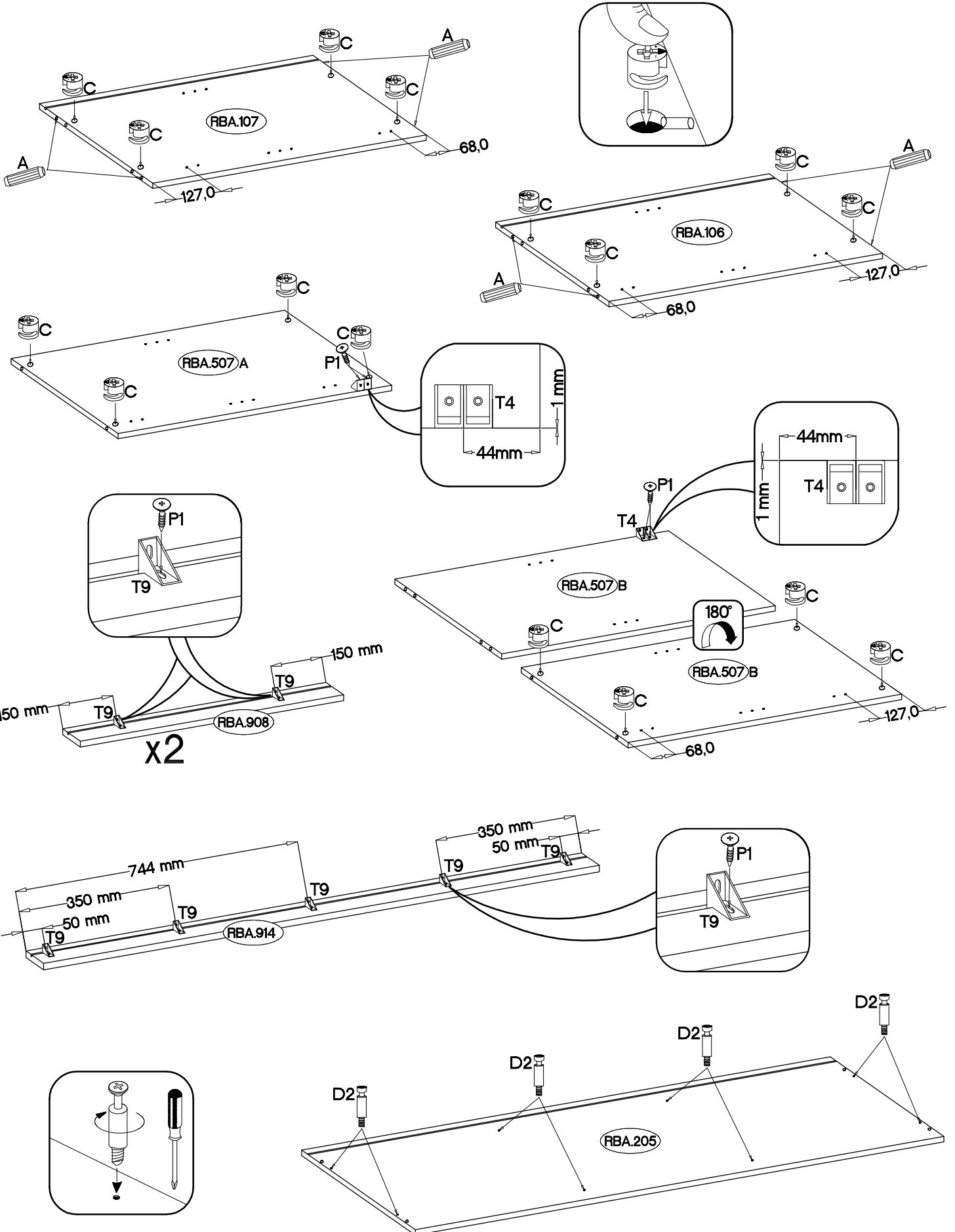

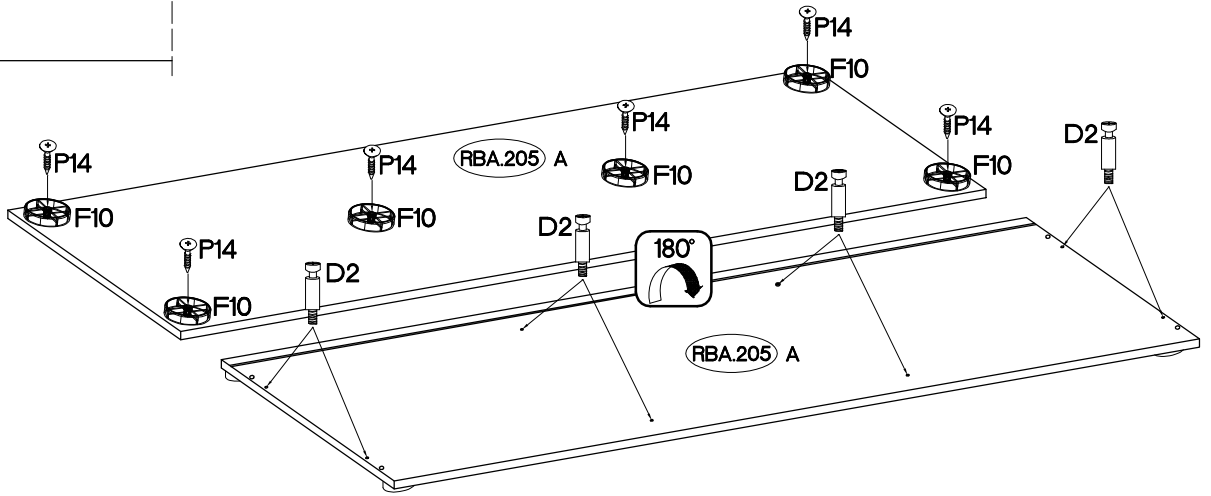
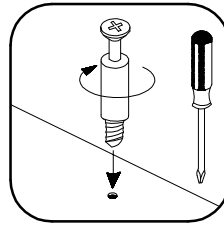
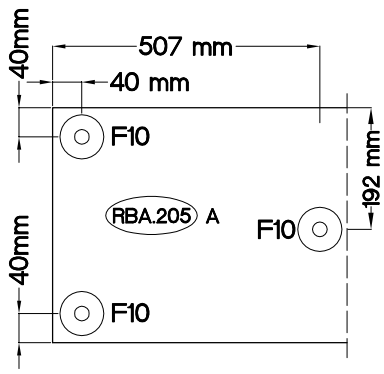

2

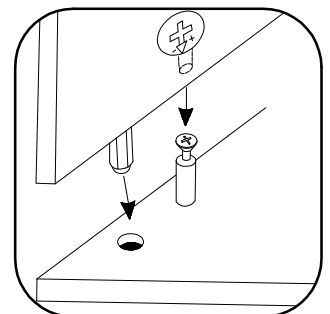
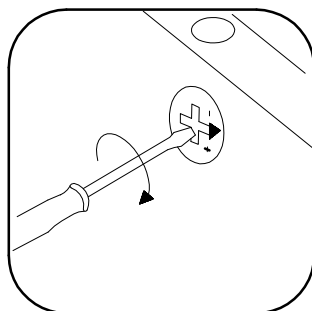
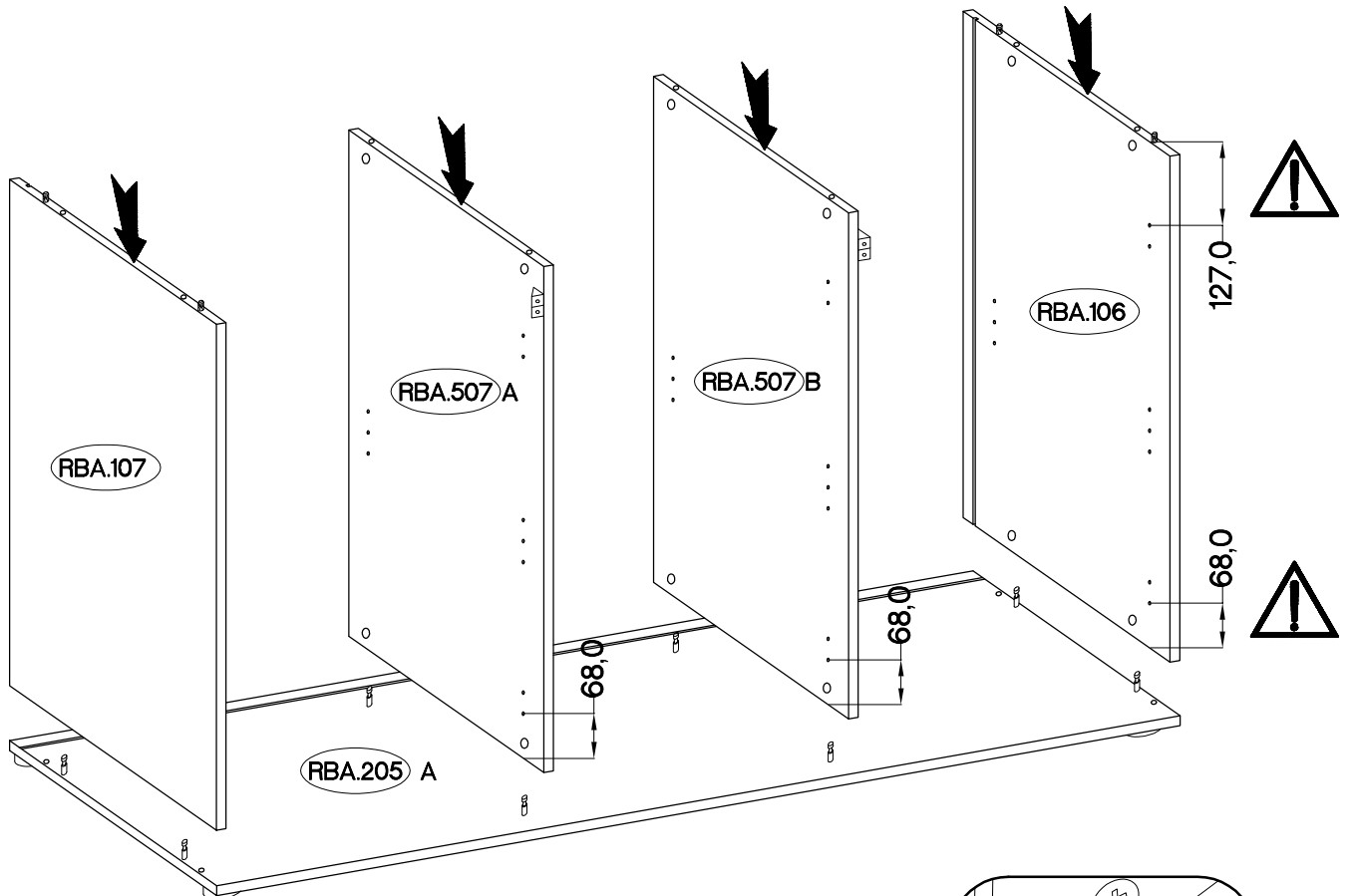

3

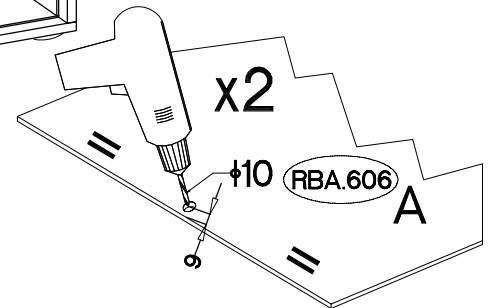
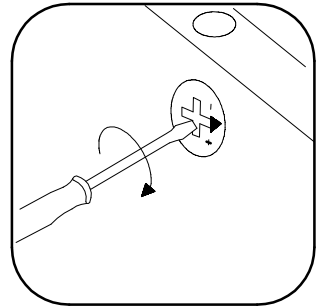
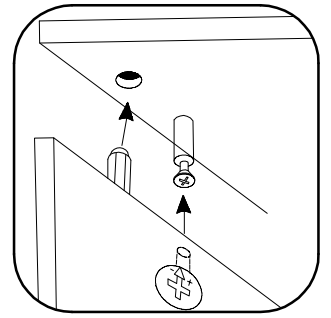
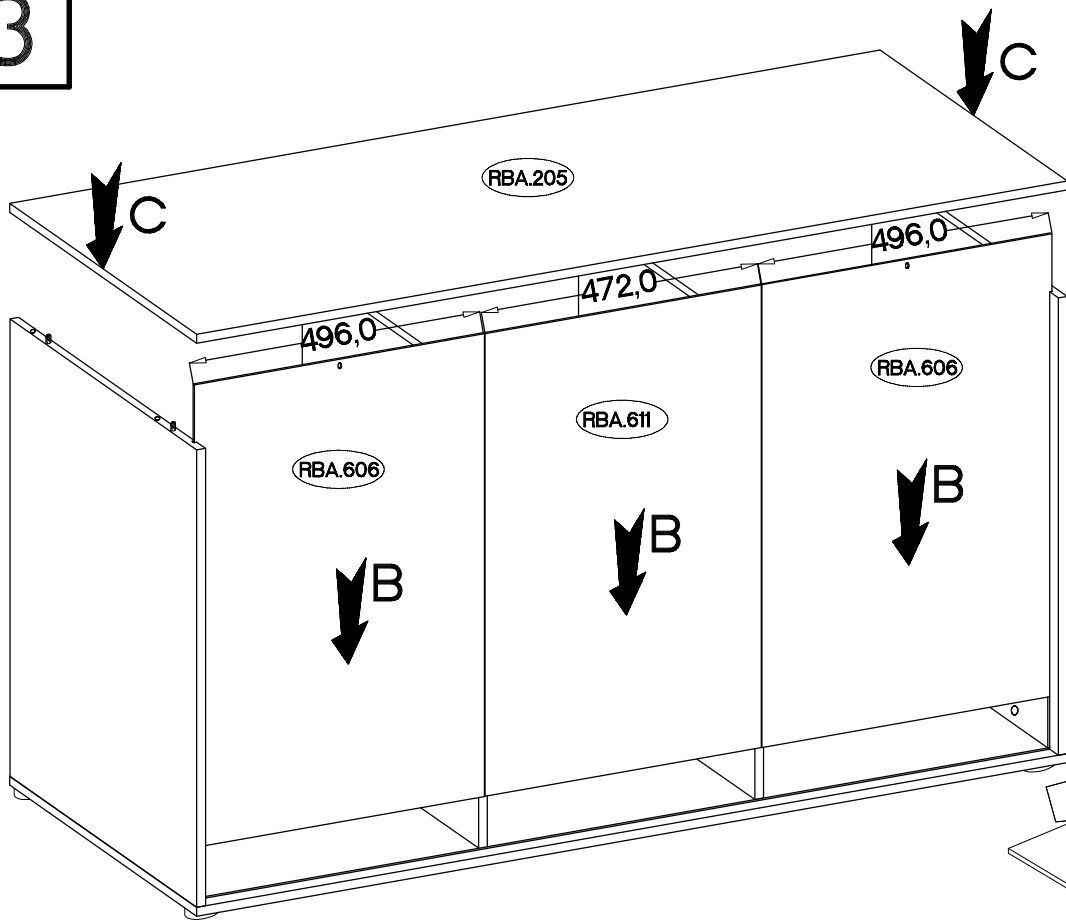

4

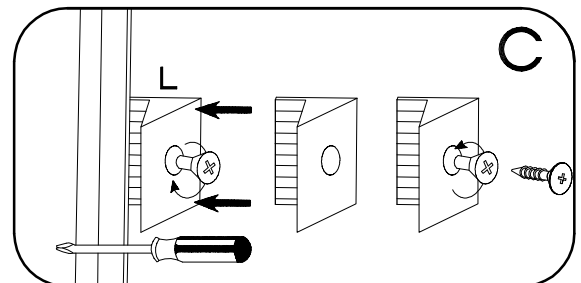
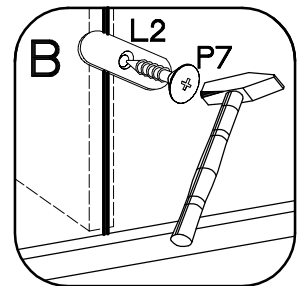
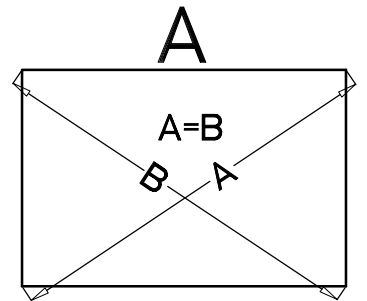
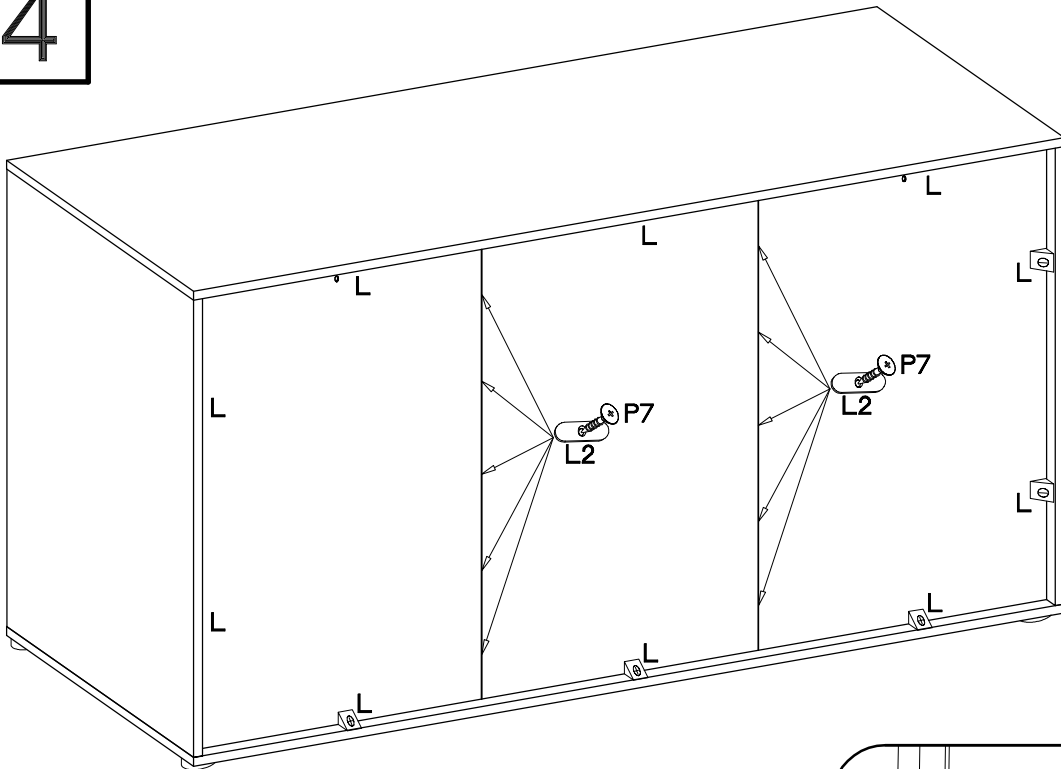

±3.0x20mm

P7	L2	L
10	10	10

5

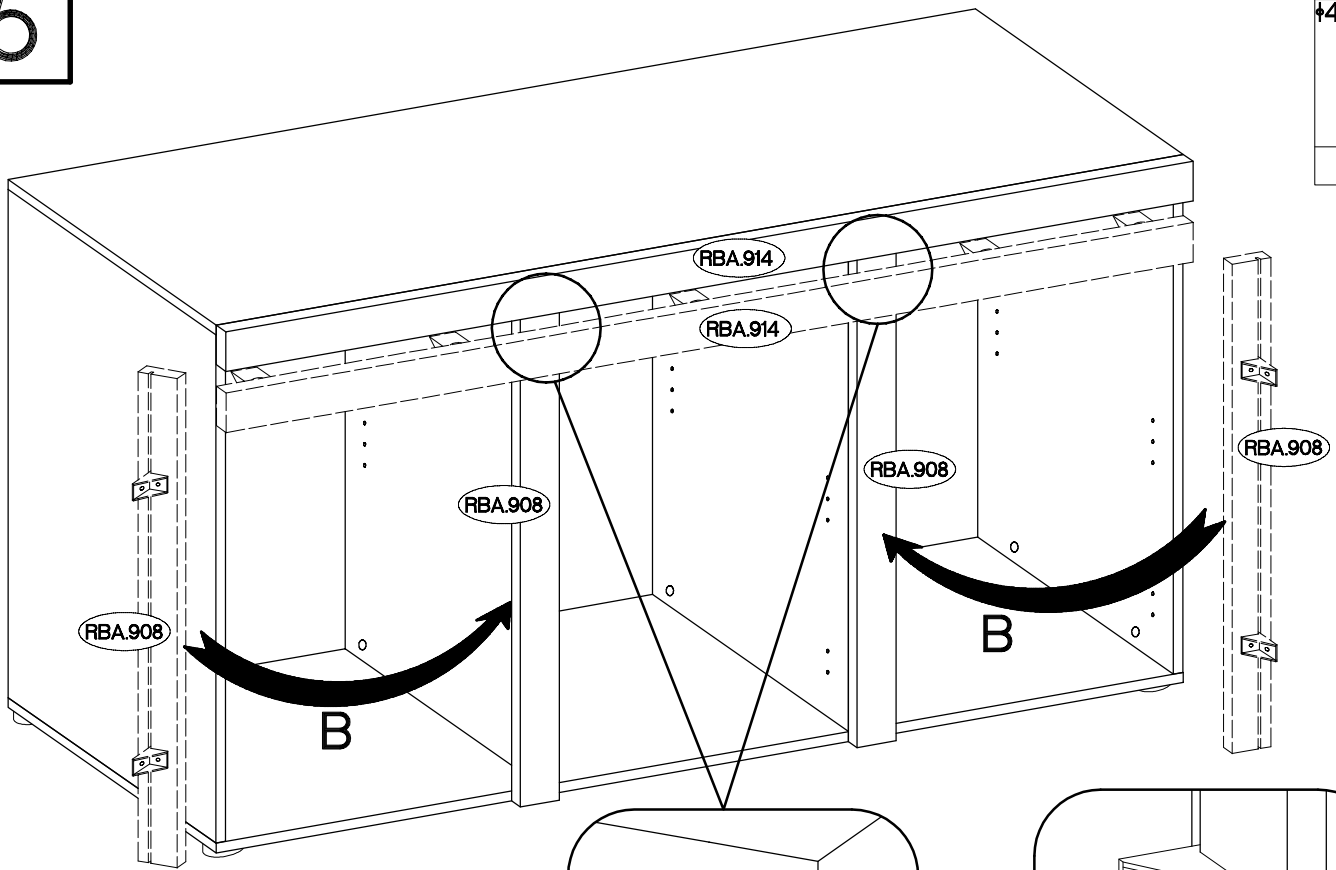

±4.0x16mm



P1

13

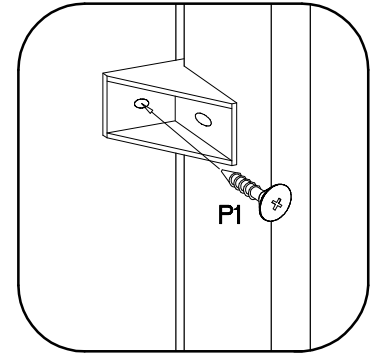
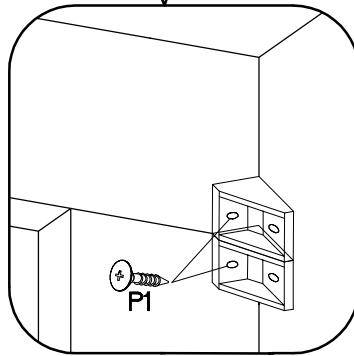

6

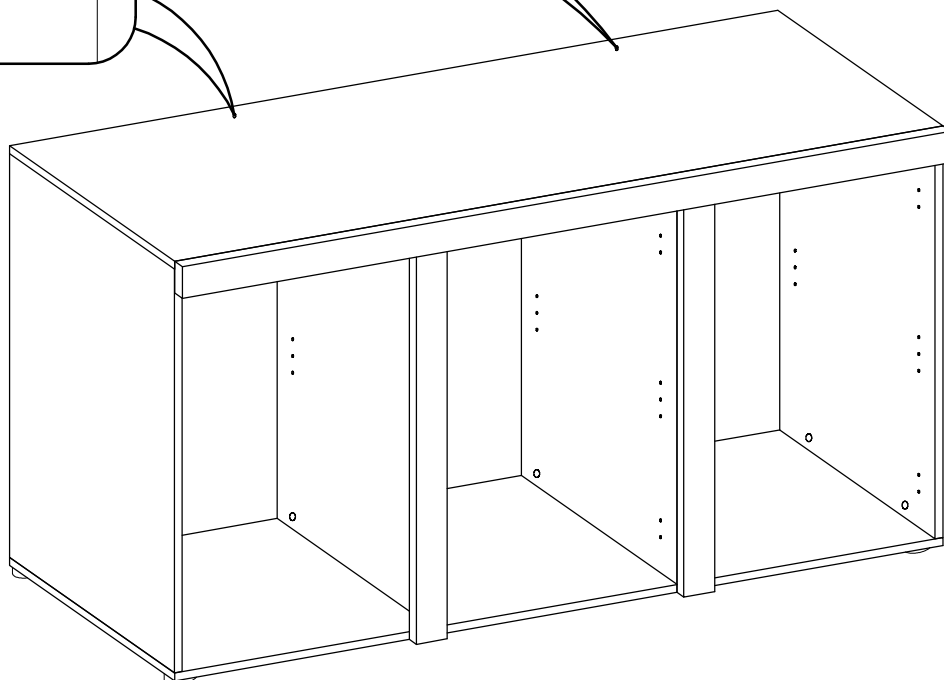
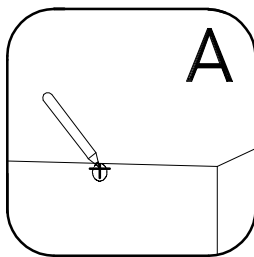

±10x50mm



O7

2

±3.5x13mm



P5

2



L9

2

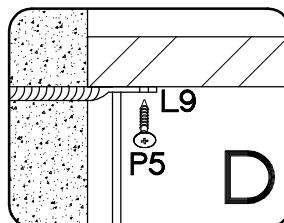
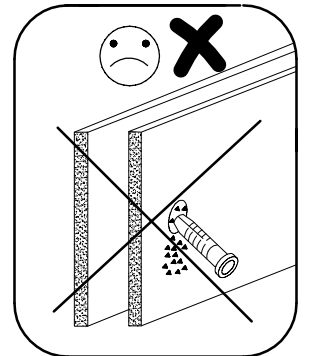
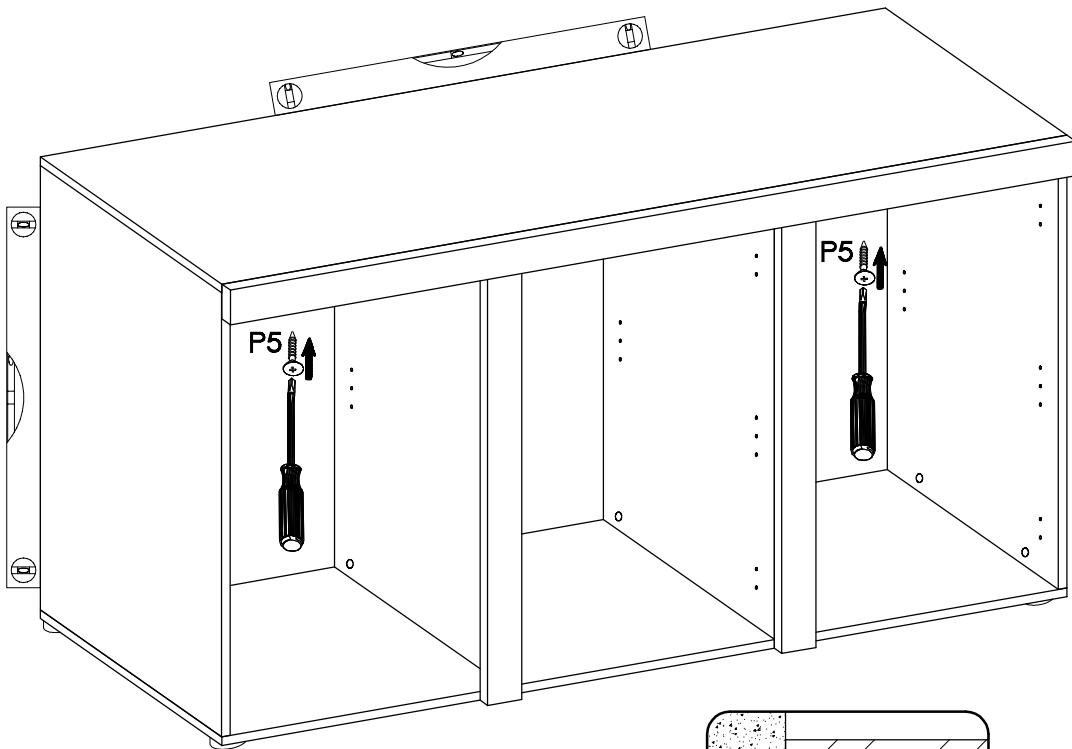
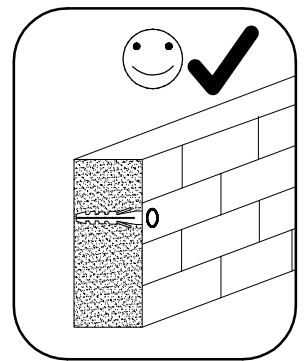
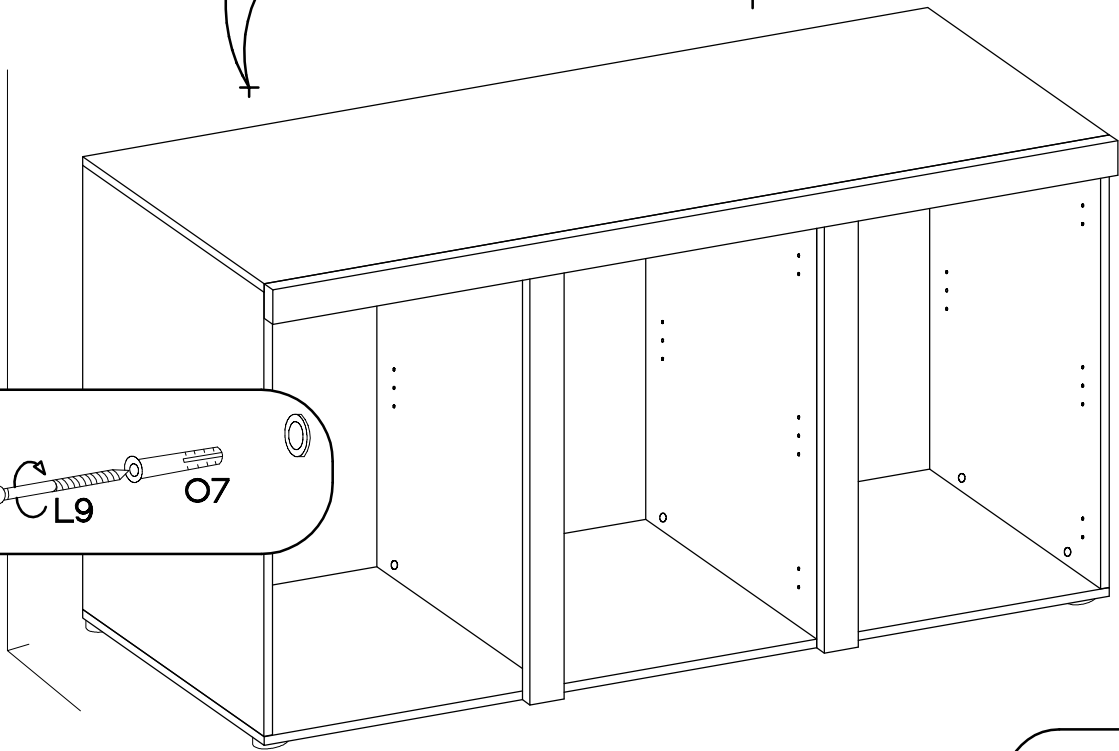
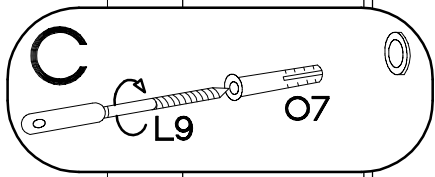
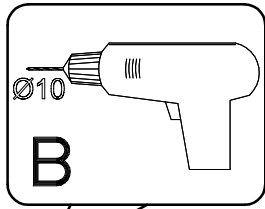

7

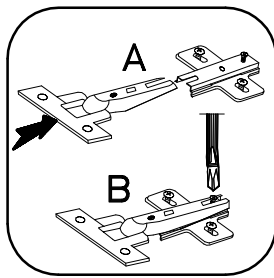

±35/16mm G2	±3.5x13mm P5
2	12
H	±35/0mm G
6	4

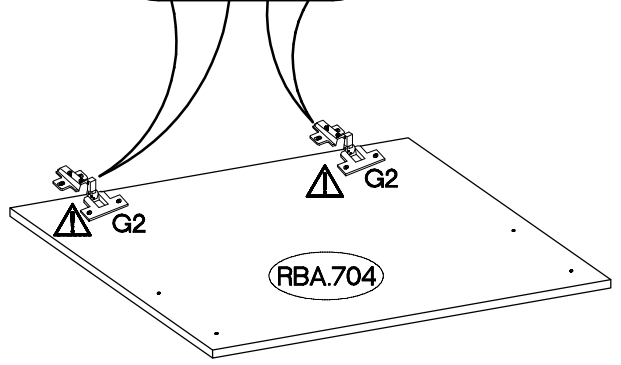
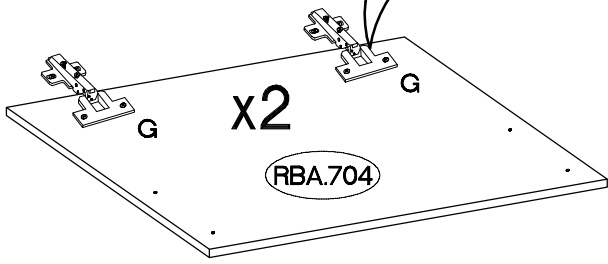
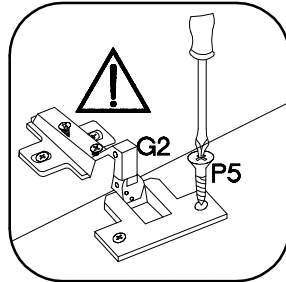
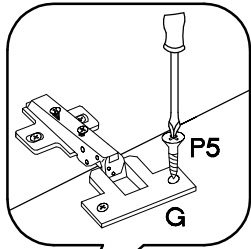

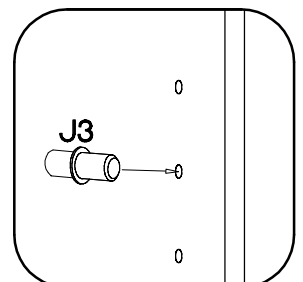
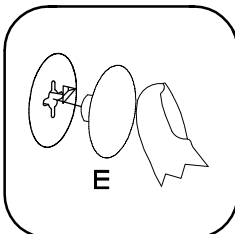
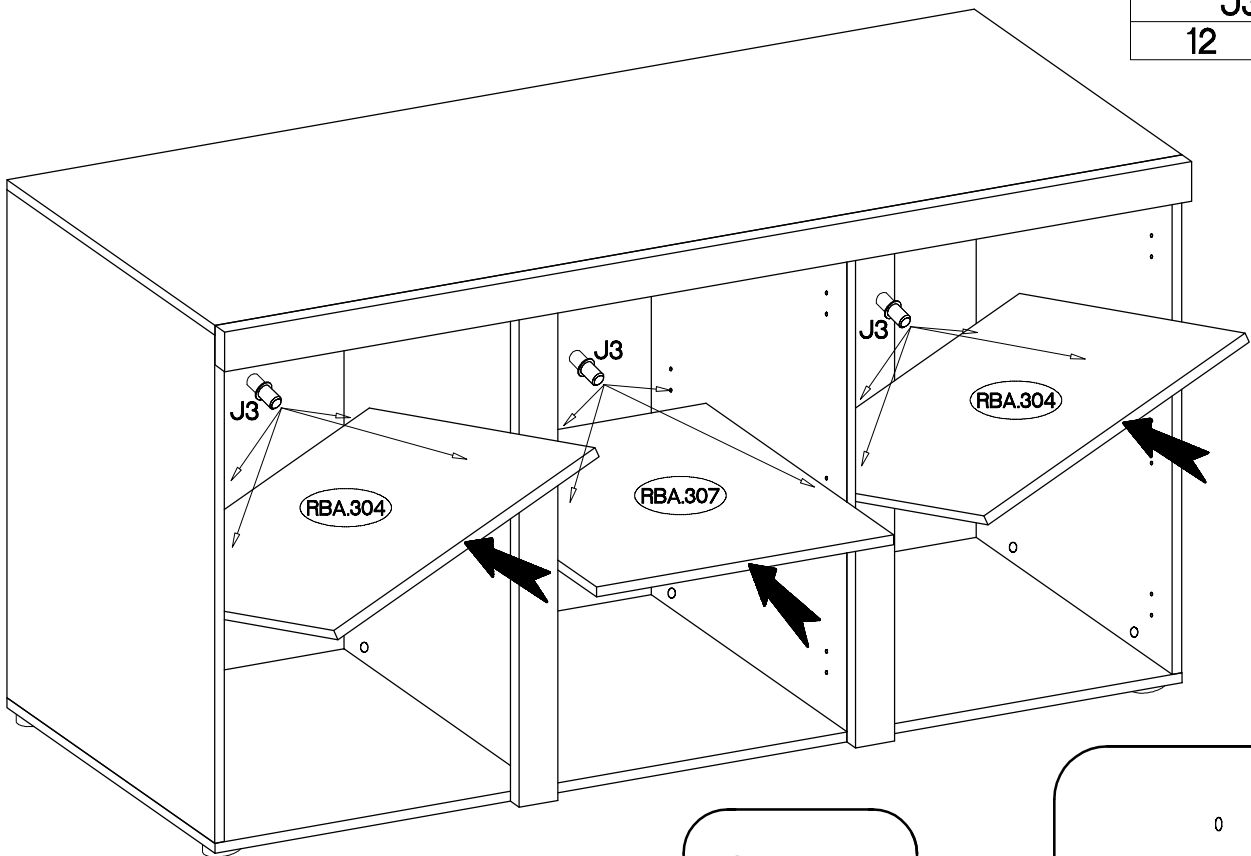

8

±5/16mm J3	E
12	16

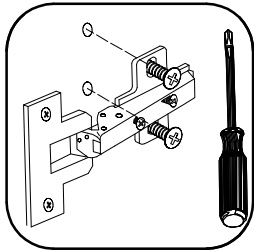

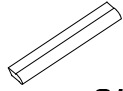

L=128mm	4.0x30mm
	
S1	R2
3	6

