

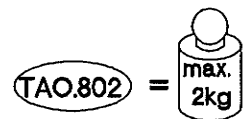

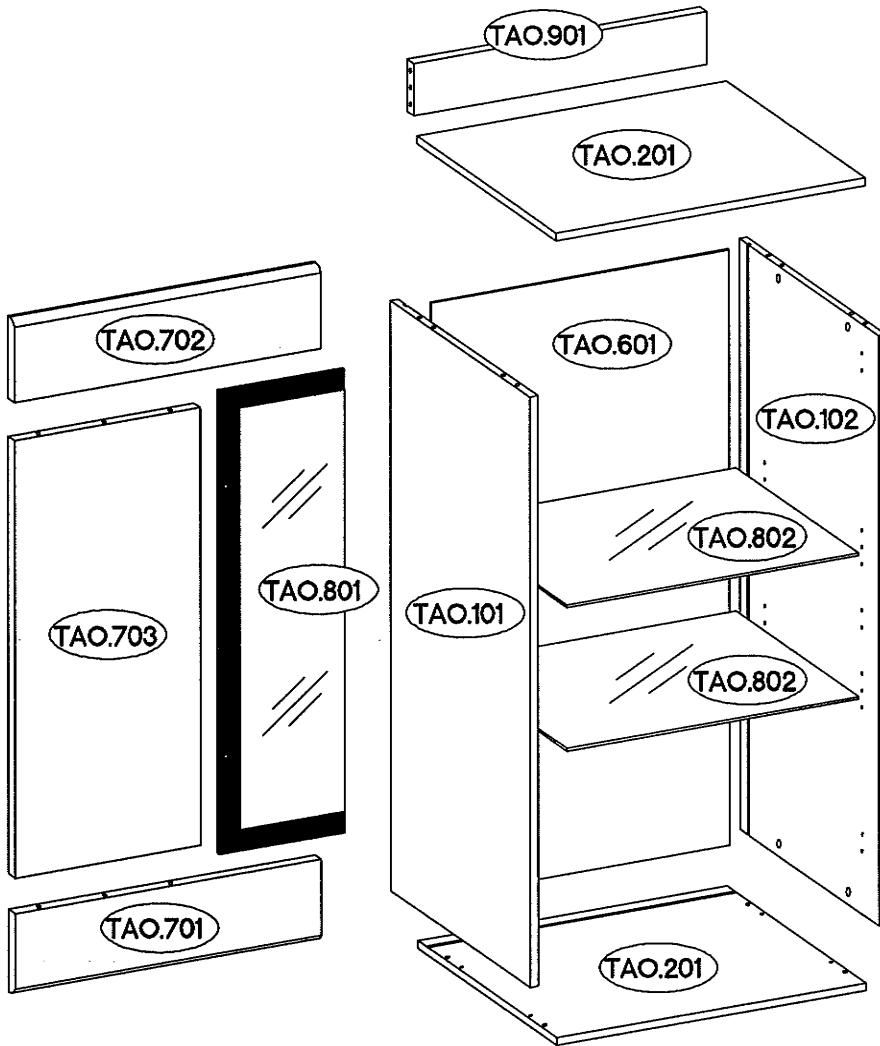

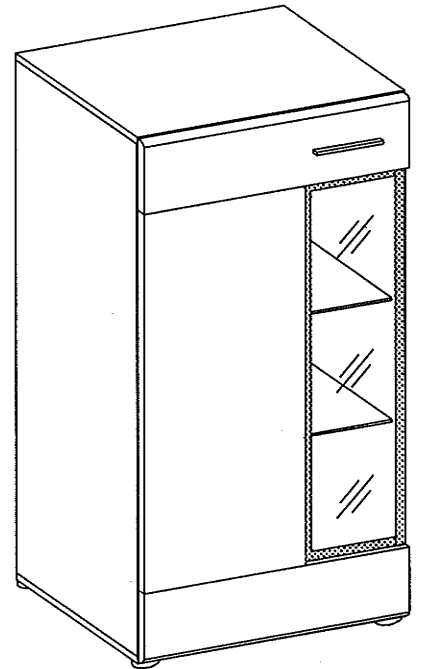























TANGO 031



											
3	3	6	4	1	5	2	2	2	8		
											
10	14	12	6	12	4	4	1	2	1	1	1

1

$\varnothing 5/12\text{mm}$	$\varnothing 8 \times 60\text{mm}$		L-56mm
			
4	4	1	2

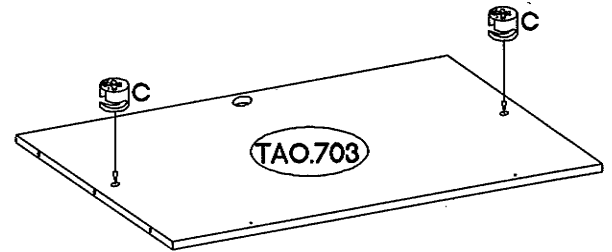
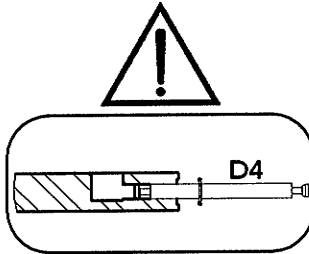
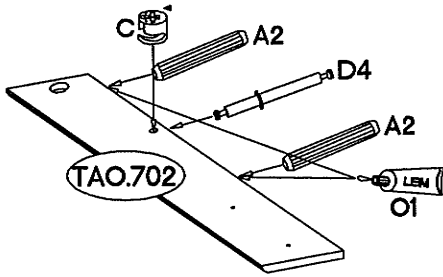
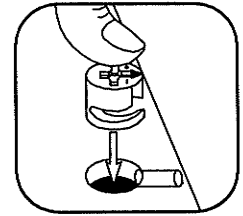
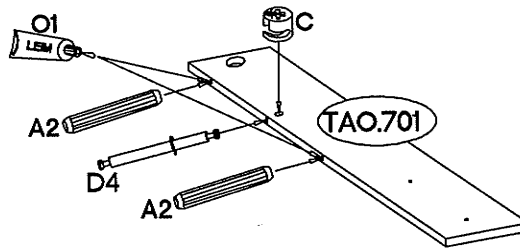

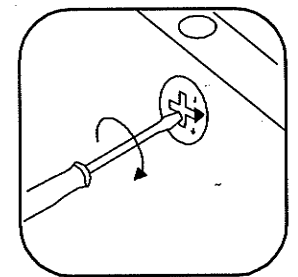
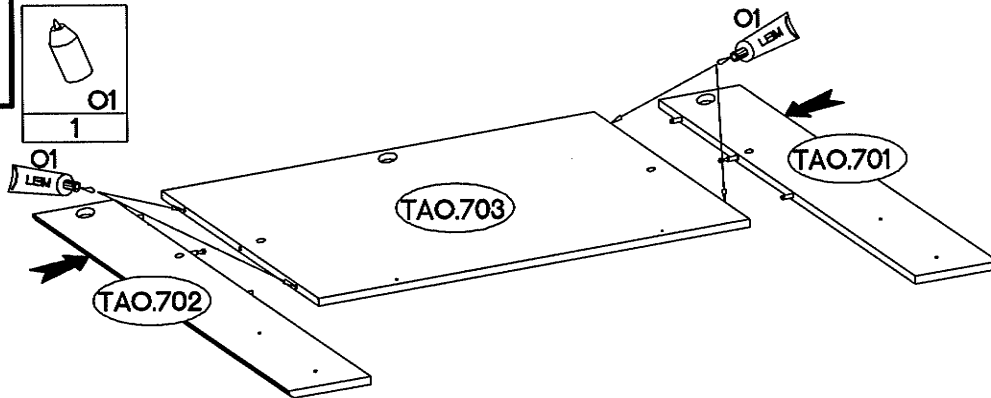

2

1



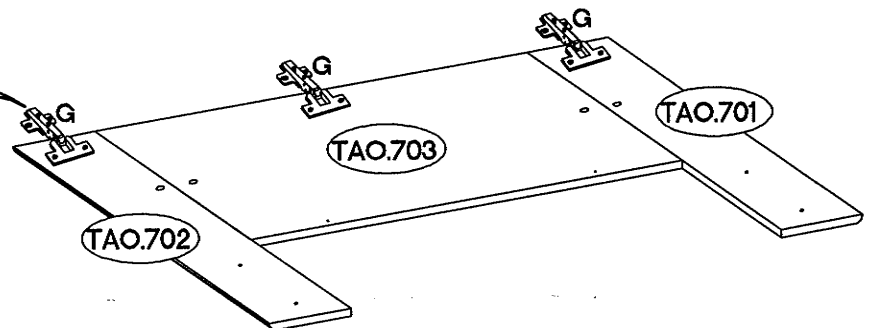
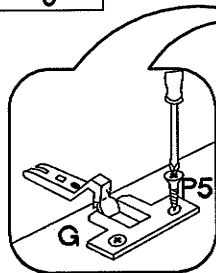
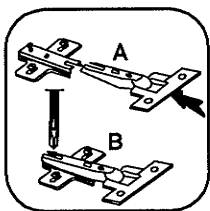

3

H-0	$\varnothing 35/0\text{mm}$	$\varnothing 3.5 \times 13\text{mm}$
		
3	3	6



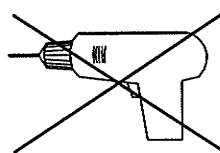
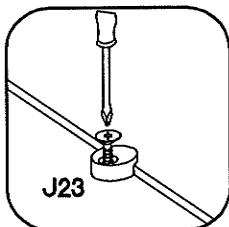



4

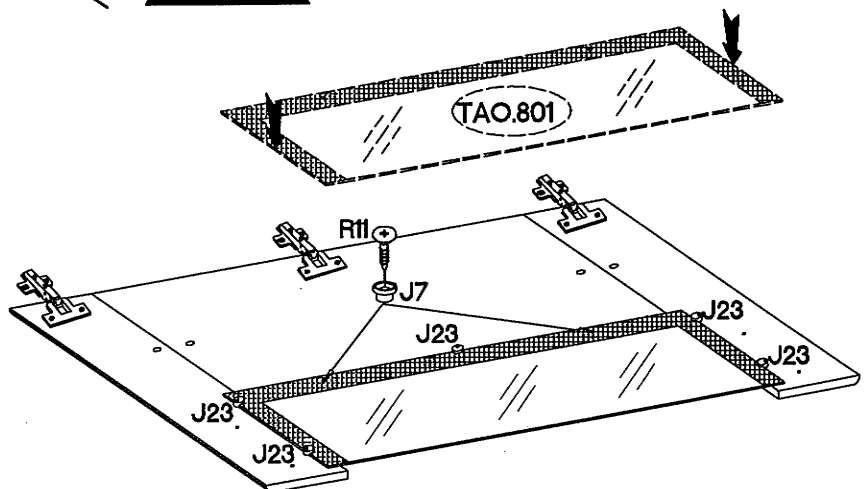
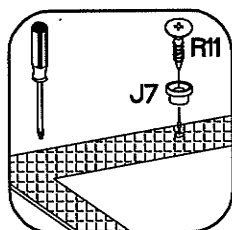

$\varnothing 4.0 \times 16\text{mm}$	$\varnothing 7/4\text{mm}$
	
J23	R11
5	2



5

L=20mm  D2 10	+5/12mm  C 10	+8x30mm  A 12	 F10 4	+4.0x25mm  P14 4
---	---	---	---	--

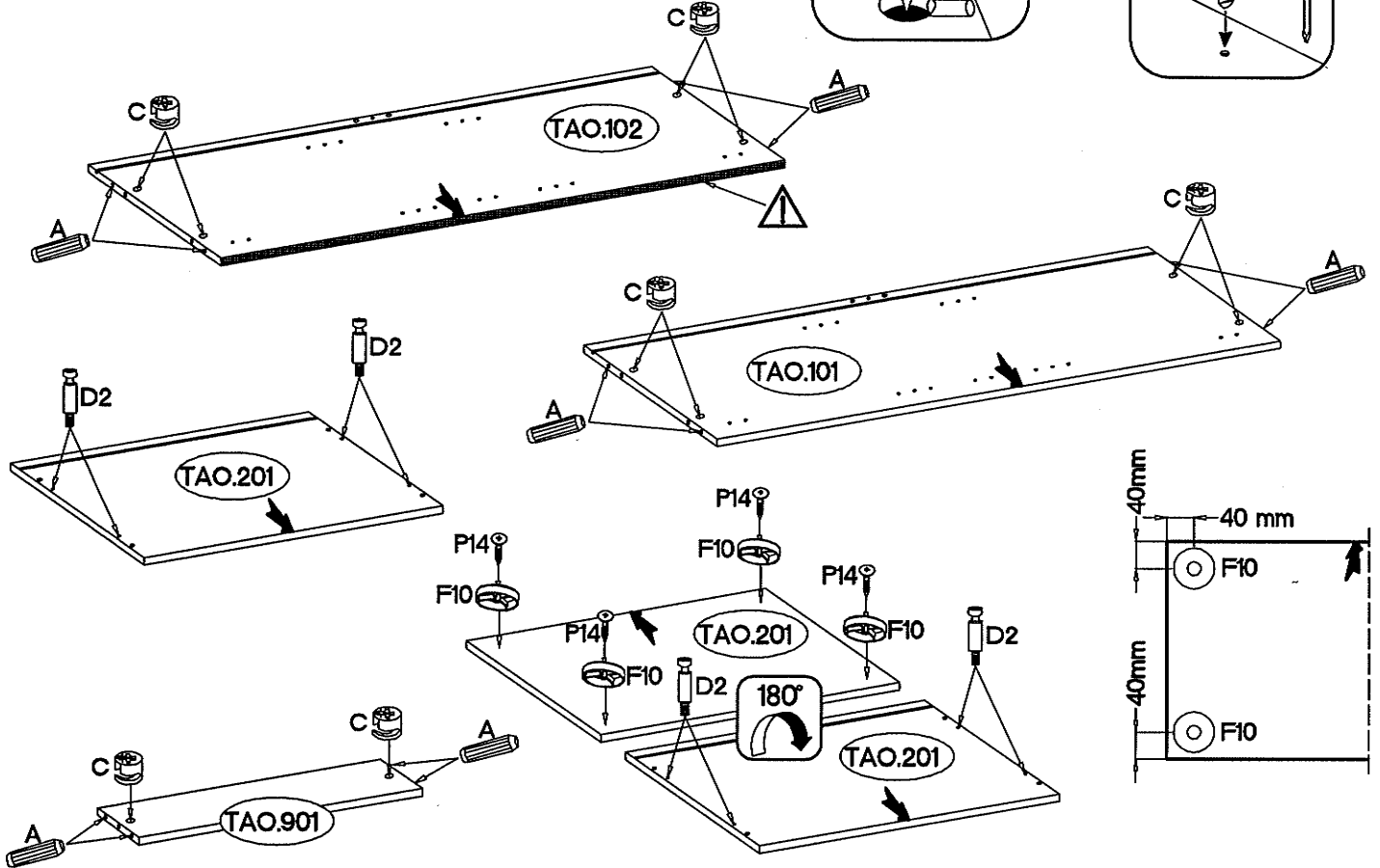
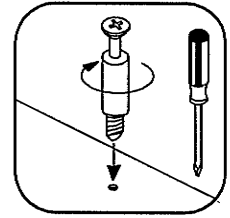
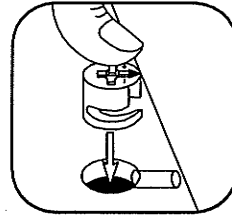

6

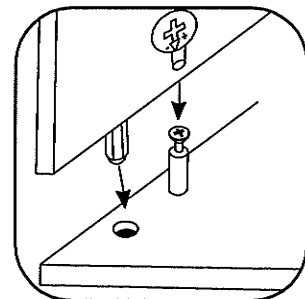
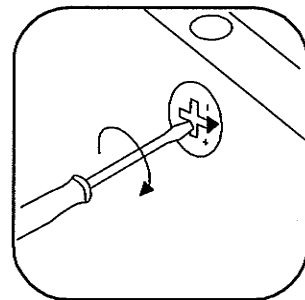
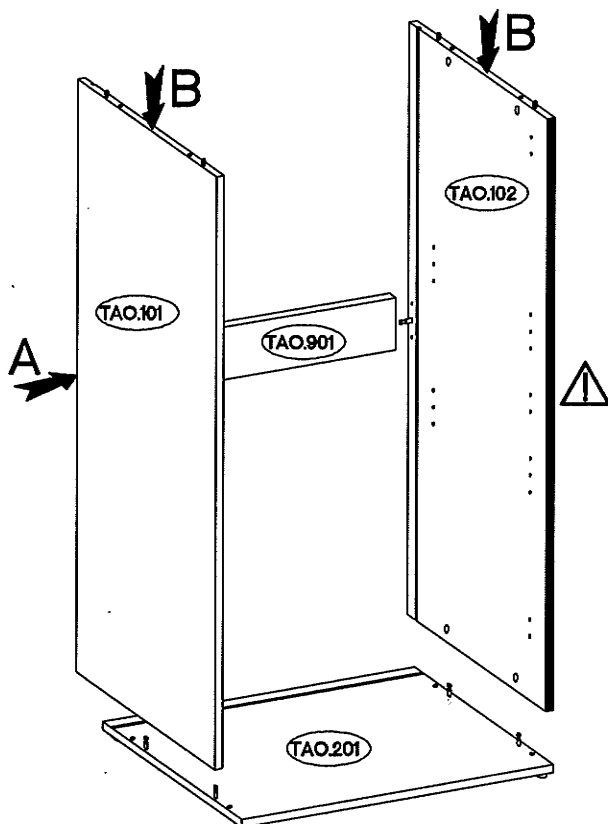

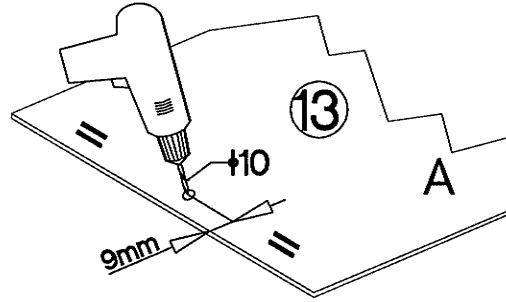
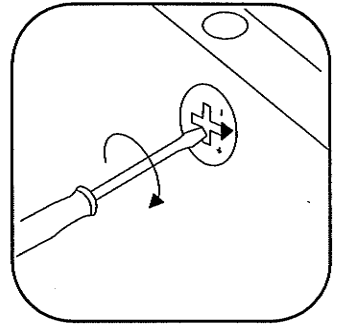
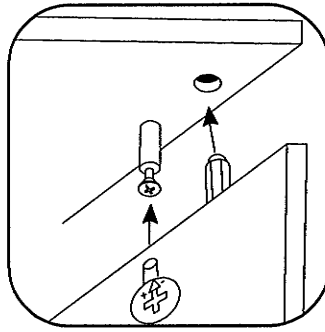
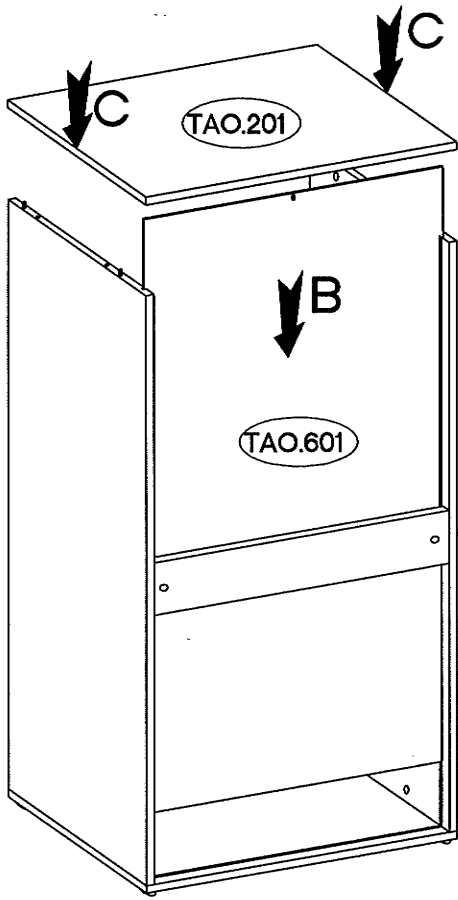

7

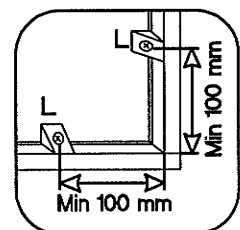
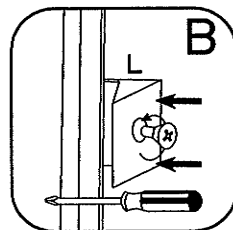
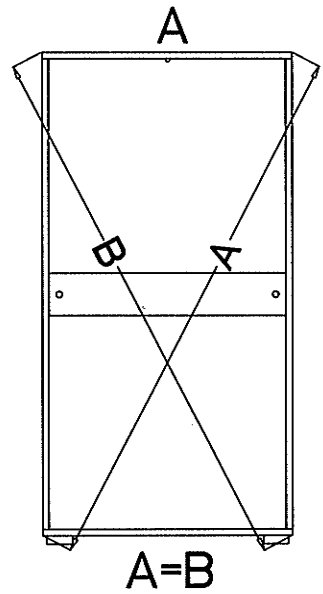
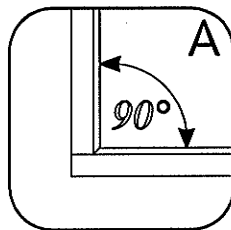
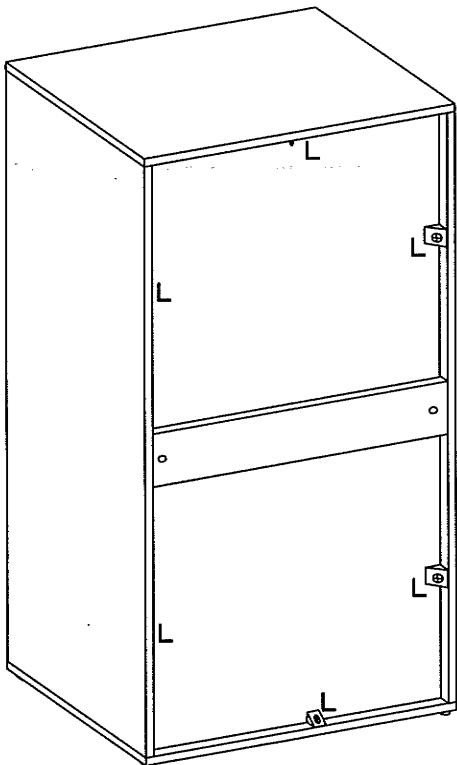
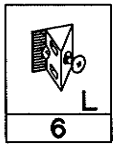

8



9

 P5	 O7	 L9
1	1	1

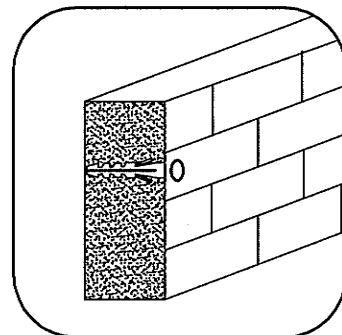
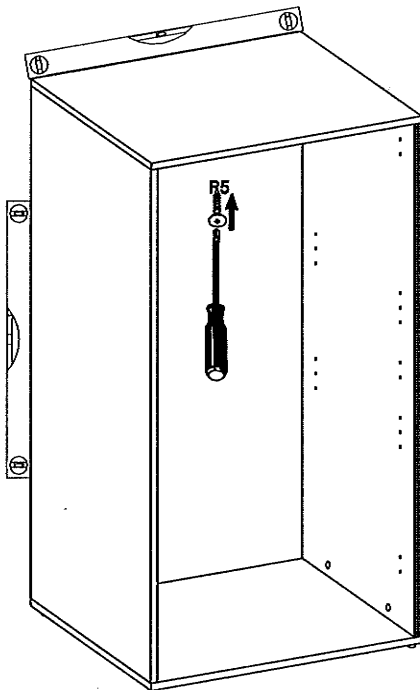
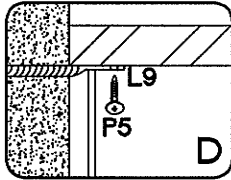
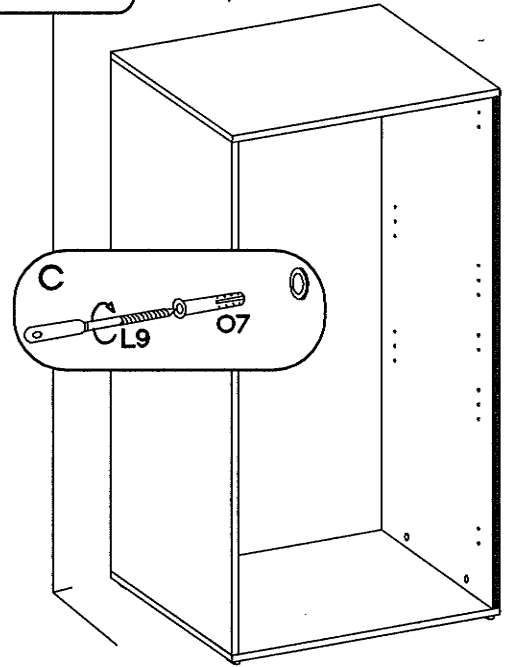
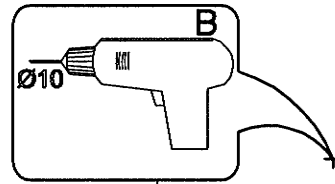
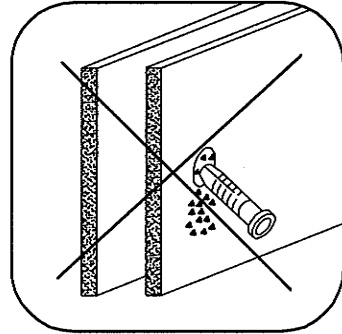
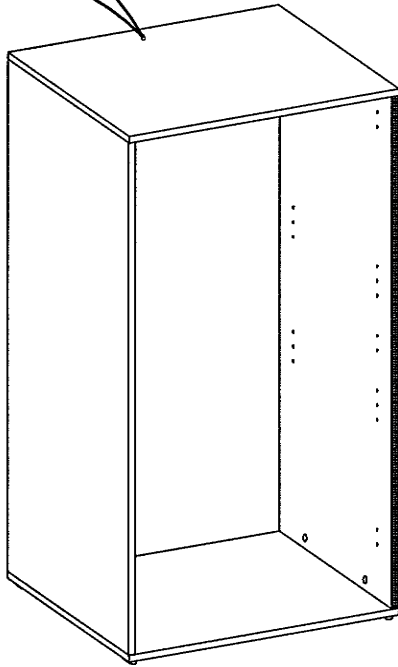
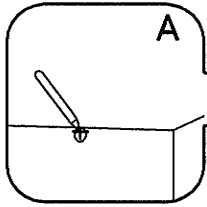

10

L=128mm S1	4.0x30mm R2	E	J12
1	2	14	8

