

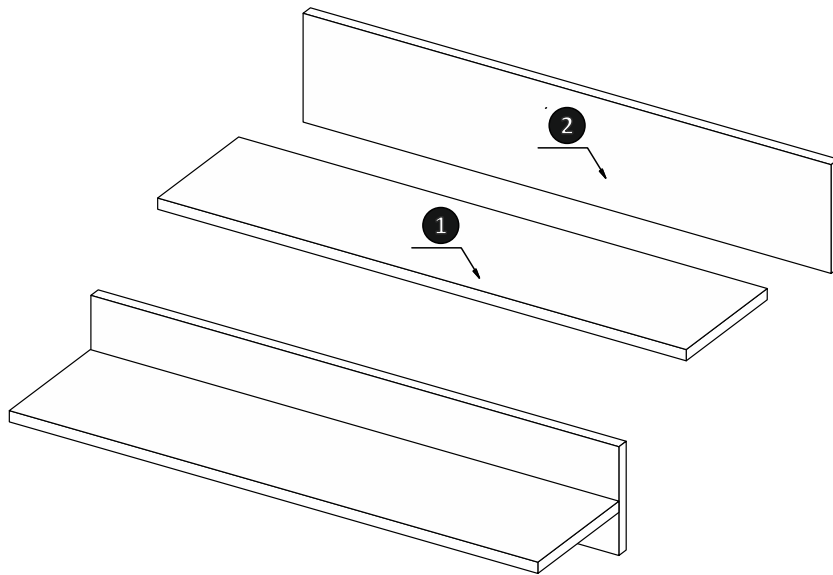

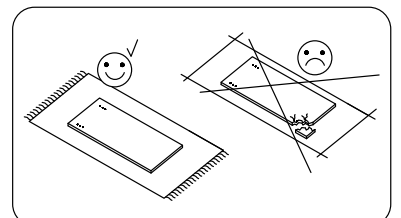

E7

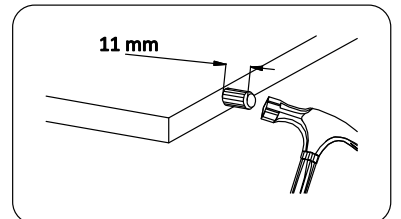
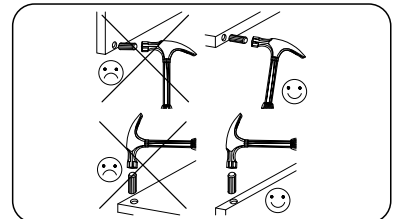
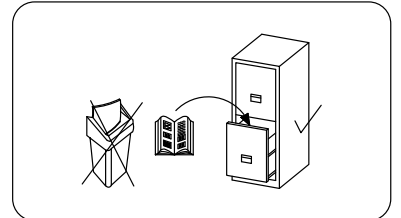
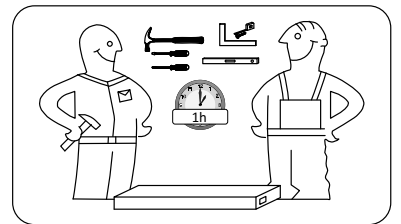
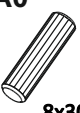
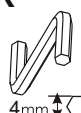

| | | | | |
|---|---|------|-----|----|
| 1 | 1 | 994 | 100 | 16 |
| 2 | 1 | 1000 | 100 | 16 |



| | | | | | |
|--|--|--|---|---|--|
| A0  8x30 | K  4mm | B2  7x70 | E3  10x50 | D22  5x11 | P1  |
| 4 | 1 | 4 | 2 | 4 | 4 |

