

PKSZ107

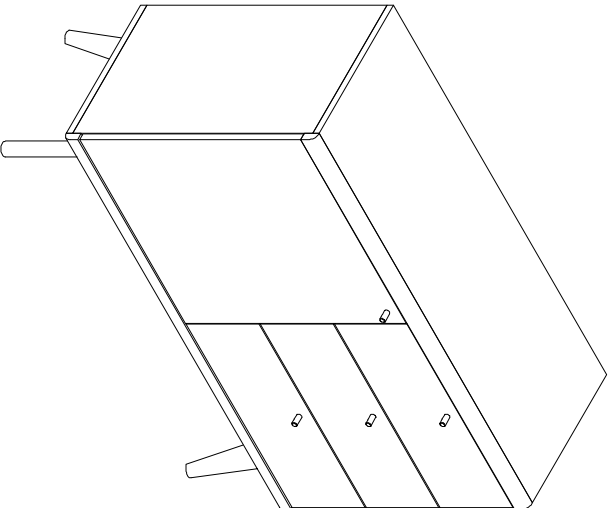

13.4.2017

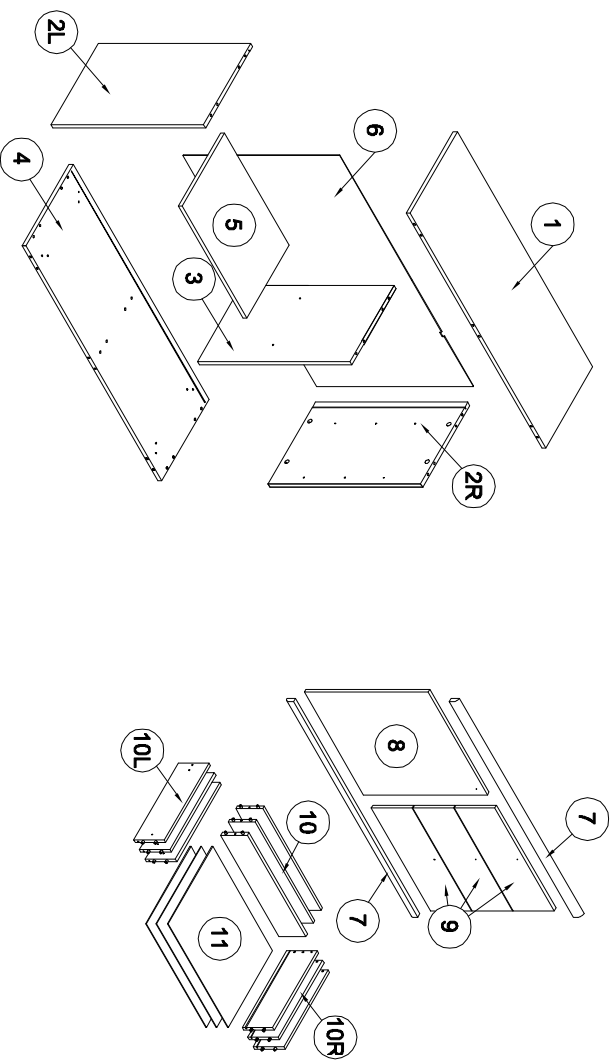

| | | | | | | | |
|---------------------|-----------------------------------|---------------------|--------------------------------|-----------------------------|-----------------------------|--------------------------------|-----------------------------|
| TB x1 | N 3x20 x4 | HD x8 | TA x1 | Z x4 | V 3x13 x18 | GLUE x1 | X x12 |
| B x18 | A 8x32 x4 x18 | R x2 | NGD x4 6.3x13 | C x18 4x13 | Z x18 | ND 3.5x16 x13 | W3 x4 |
| | | | H x4 6.3x13 | NA x4 4x13 | PPW x6 | PC x2 | M x4 M4x22 |

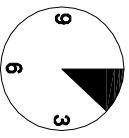
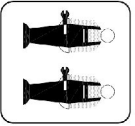
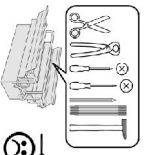

20 min.

1

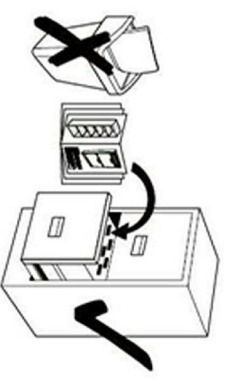
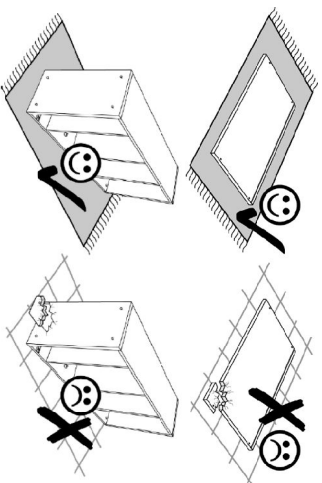

2

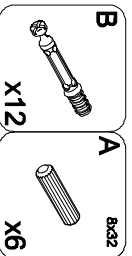
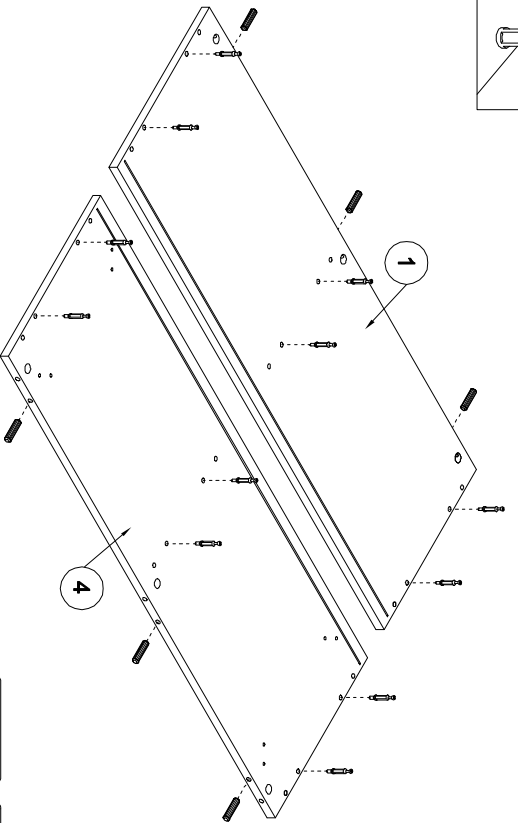
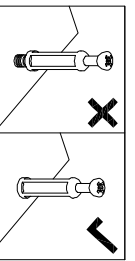

3

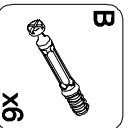
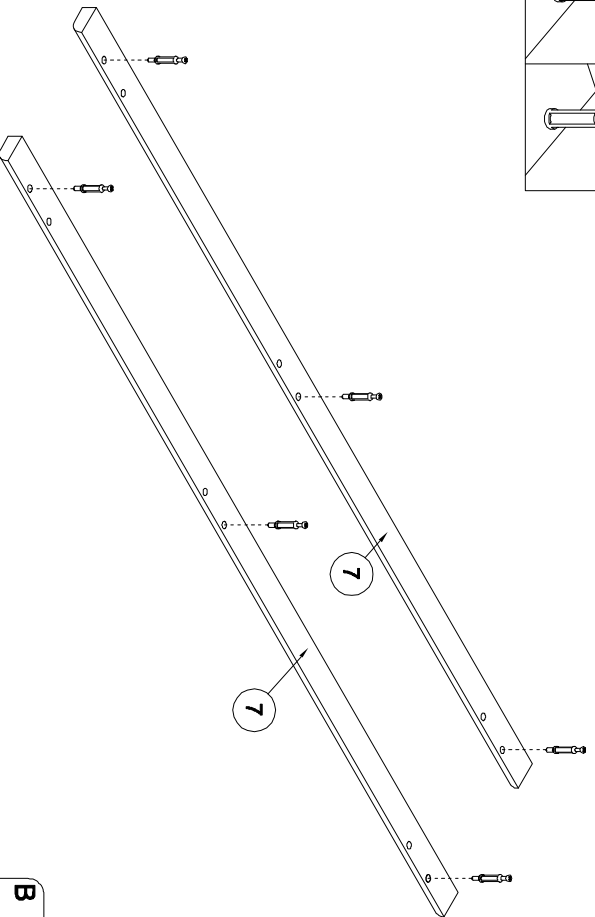
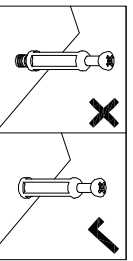

4

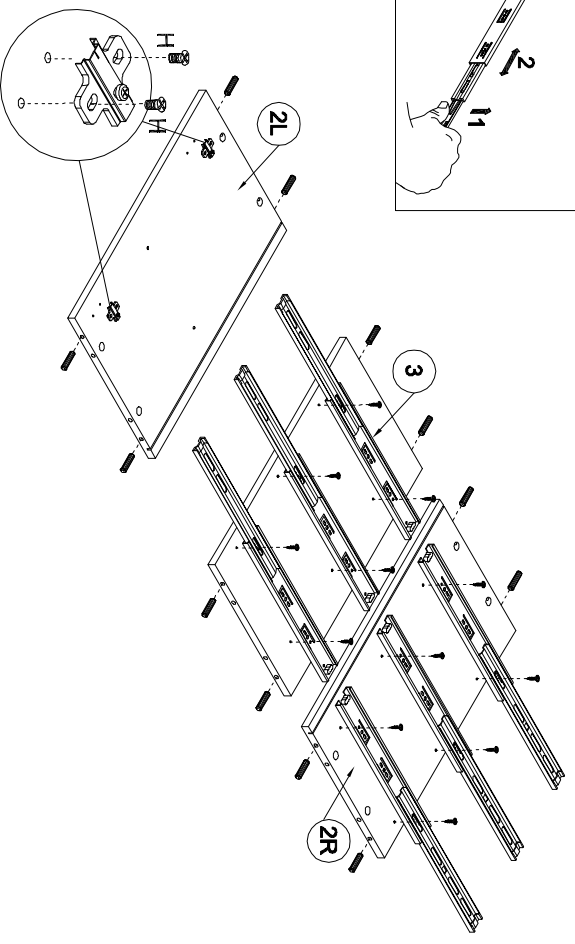
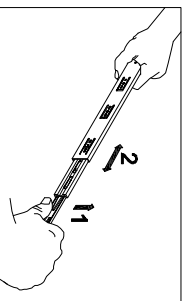
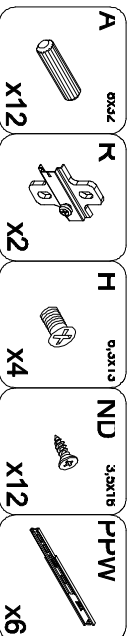

5

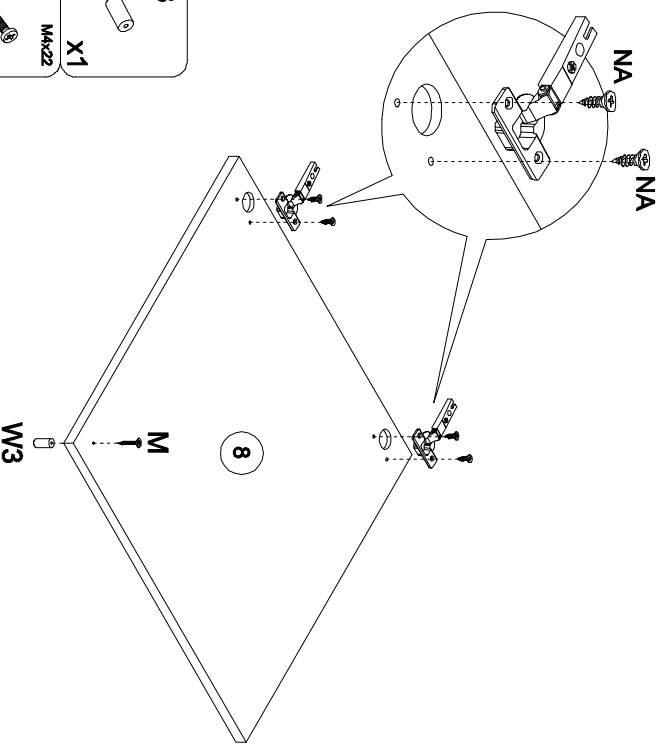
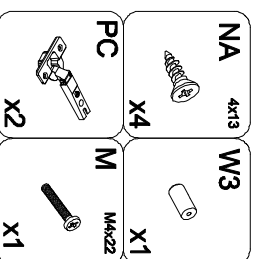

6

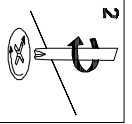
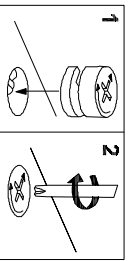

7

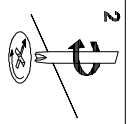
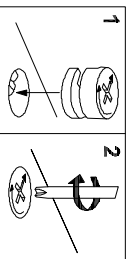
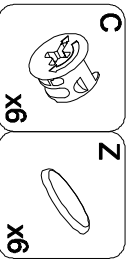
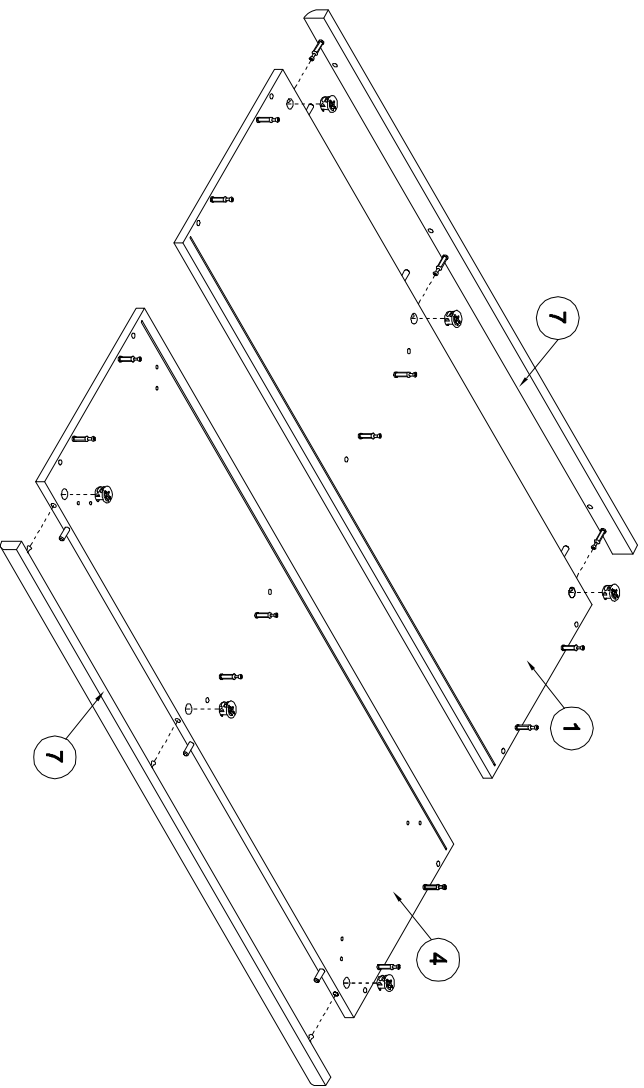

8

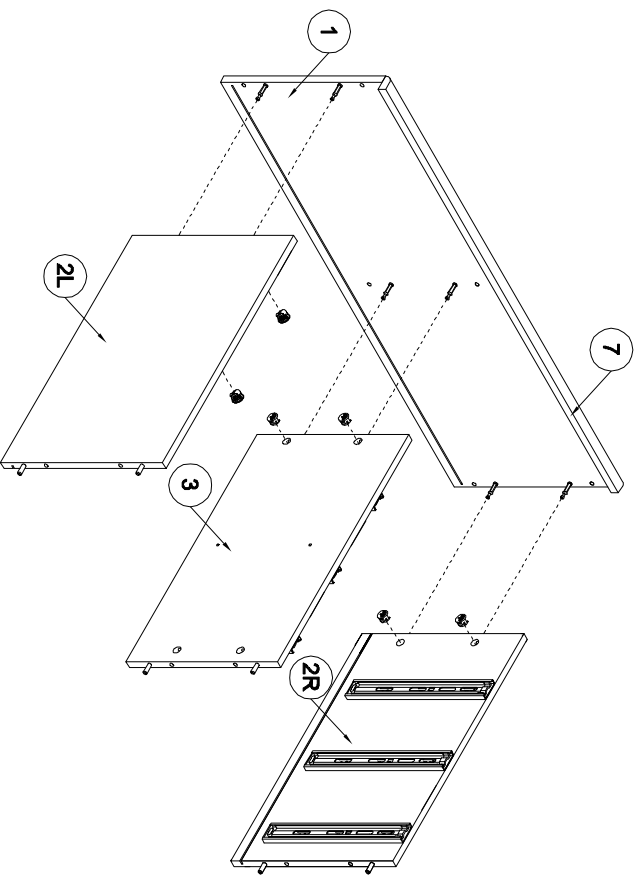

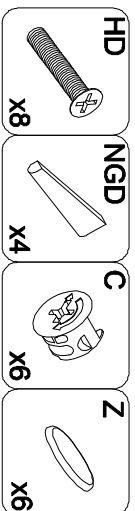
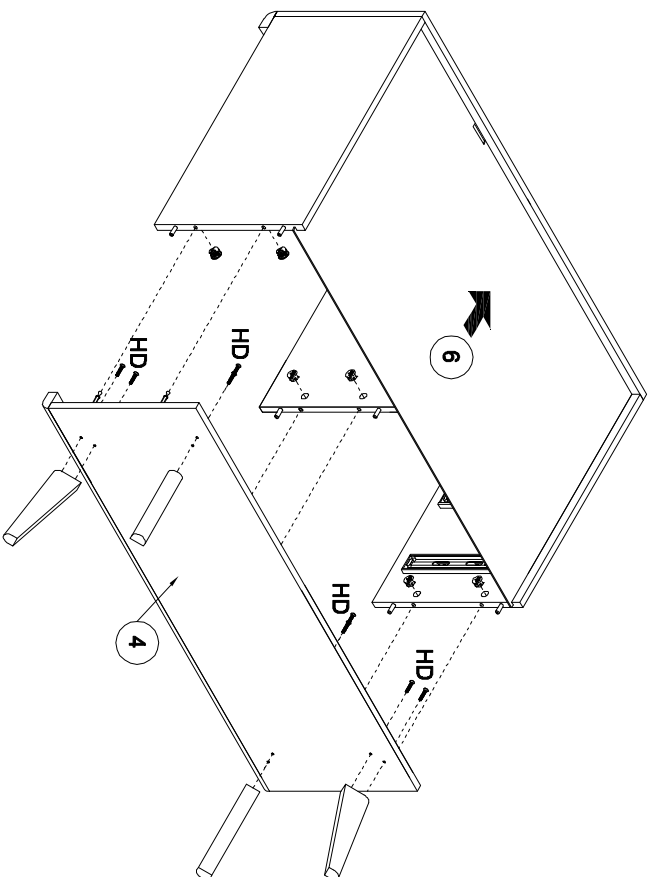
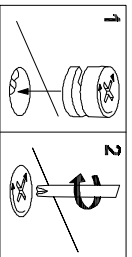

9

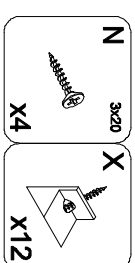
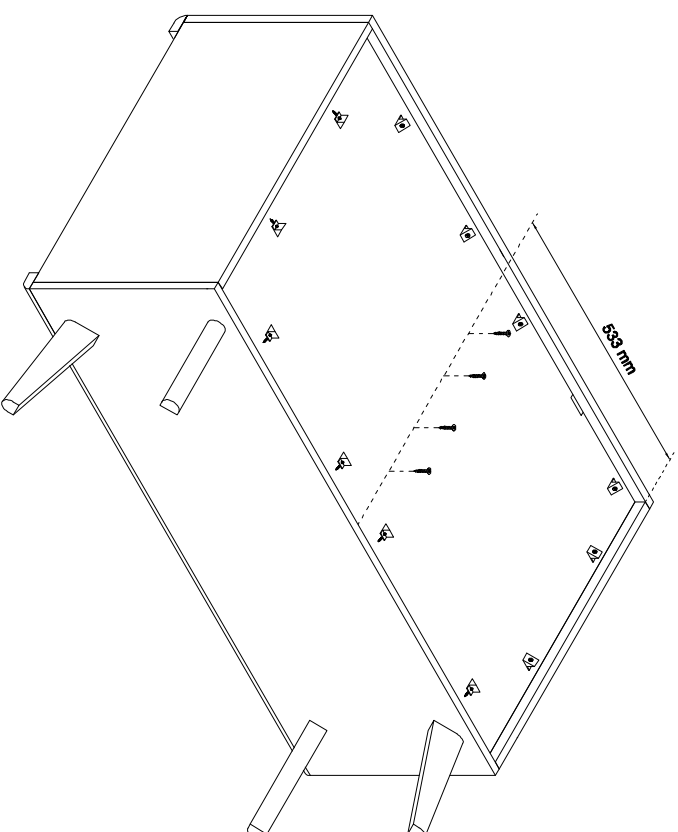
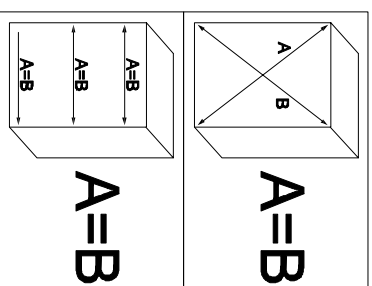

10

11

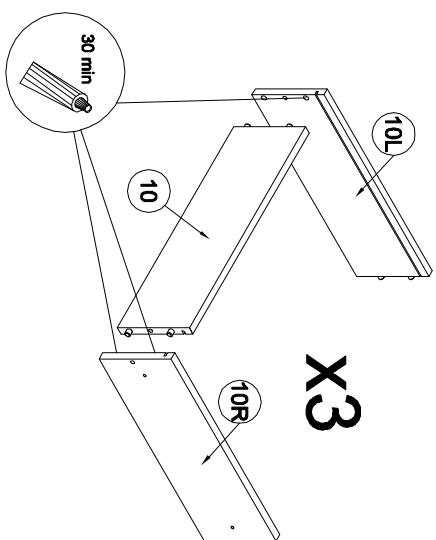

X3

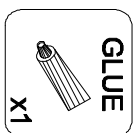

12

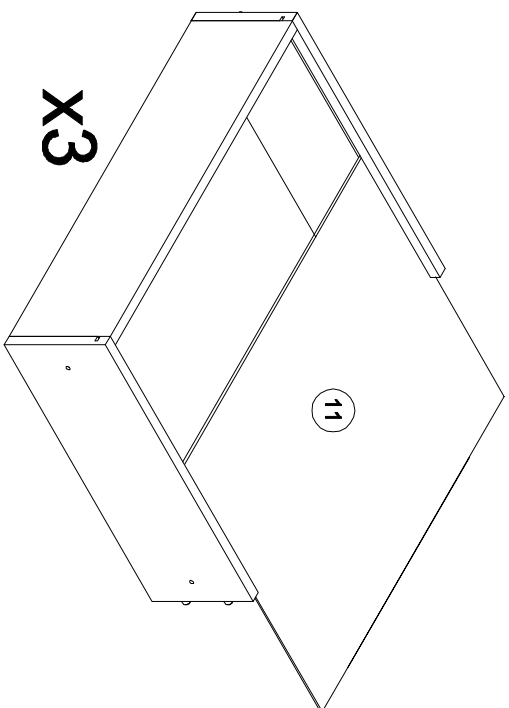

X3

13

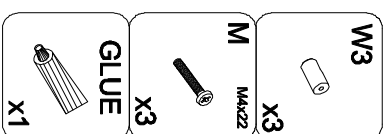
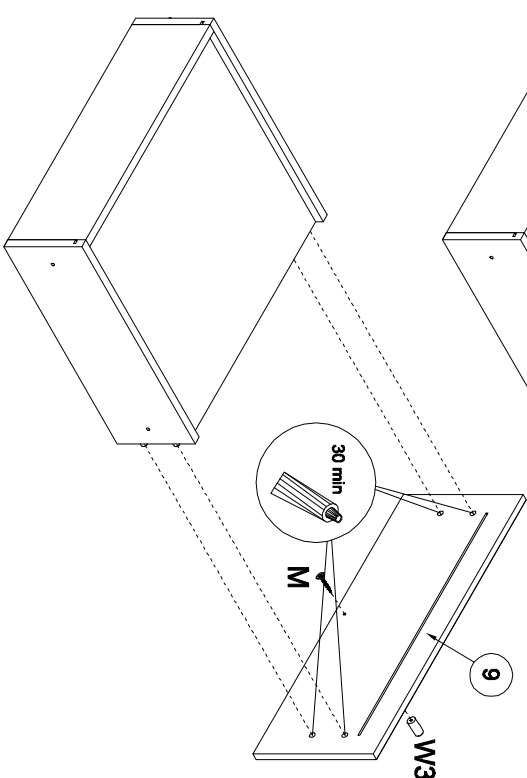
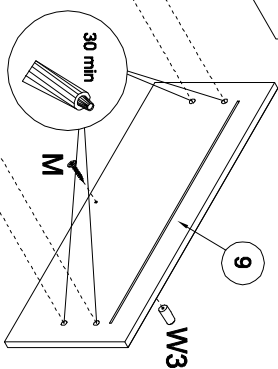
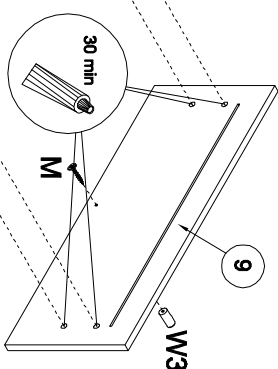

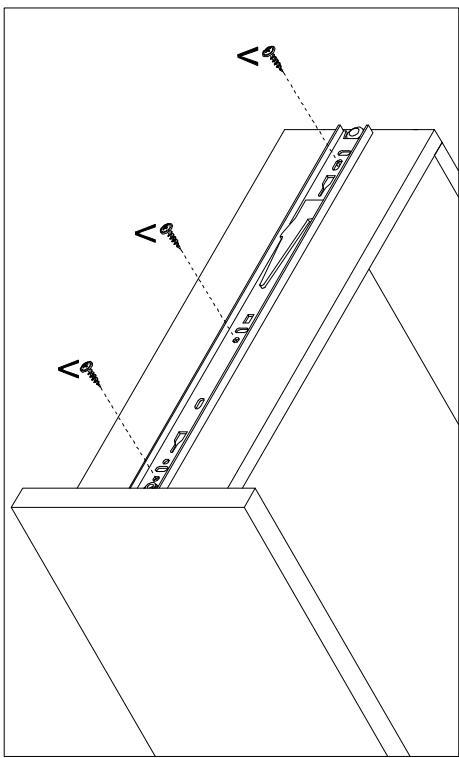
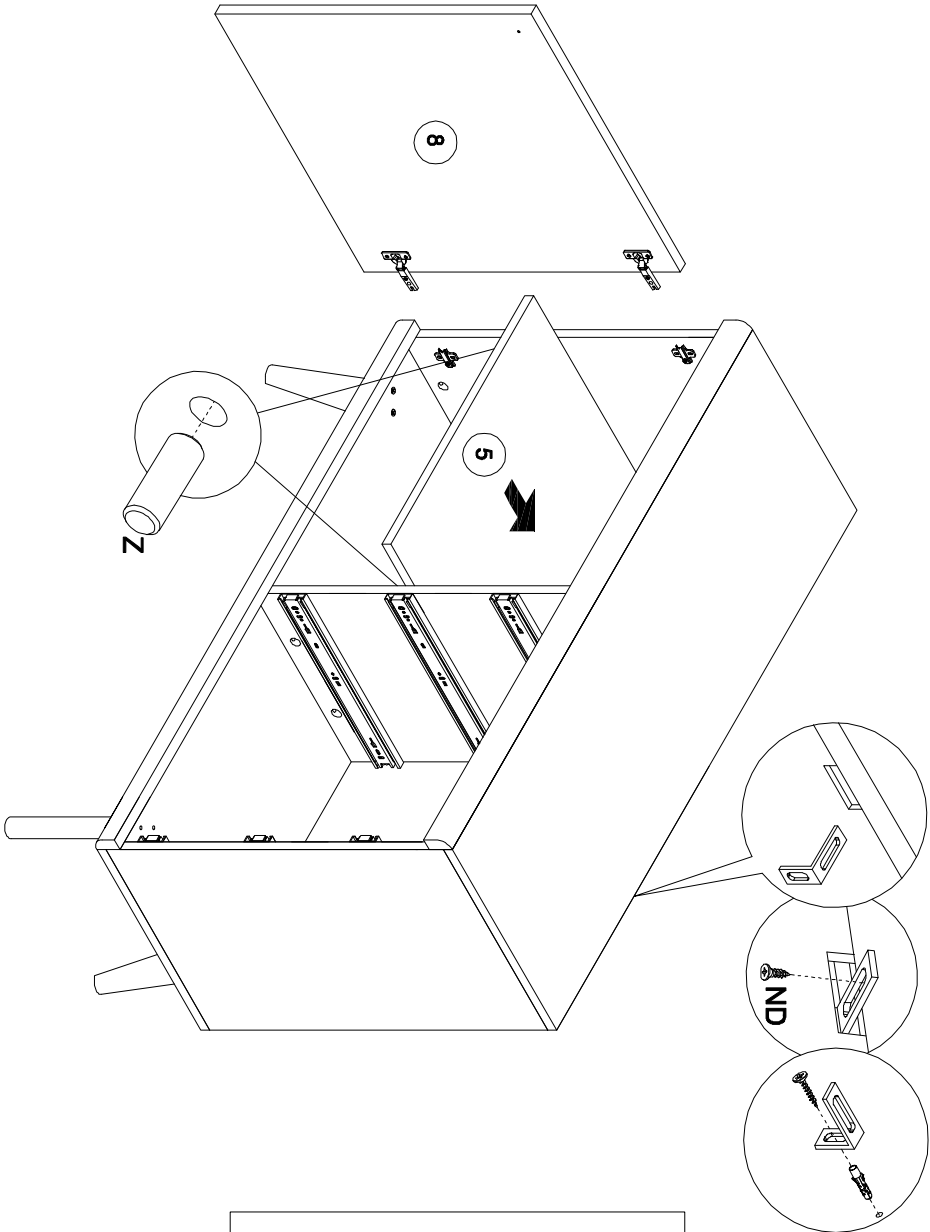
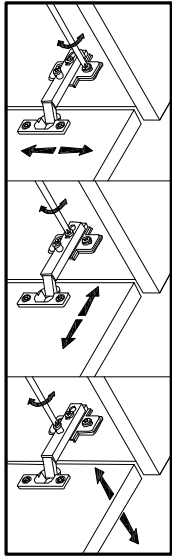

- TB 3x13 X1
- TA X1
- Z X4
- V 3x13 X18
- ND 3.5x16 X1

