

PK107

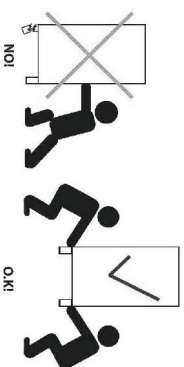

14.10.2016

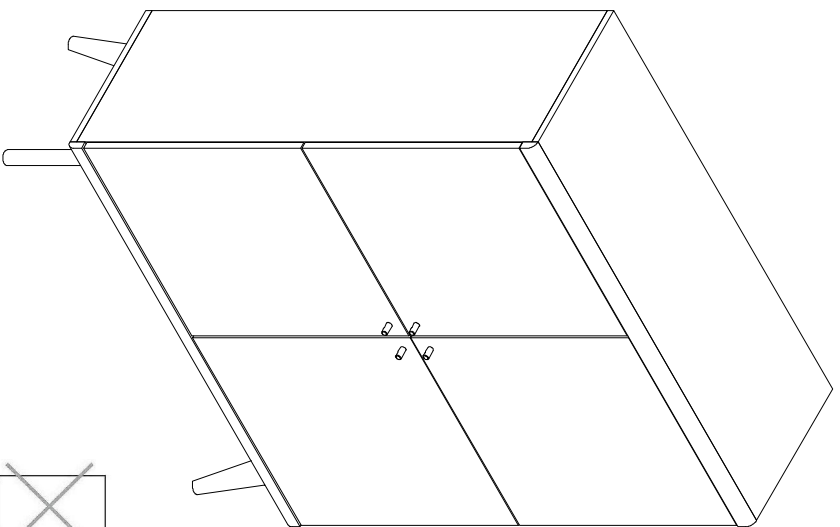
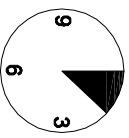

20 min.

1

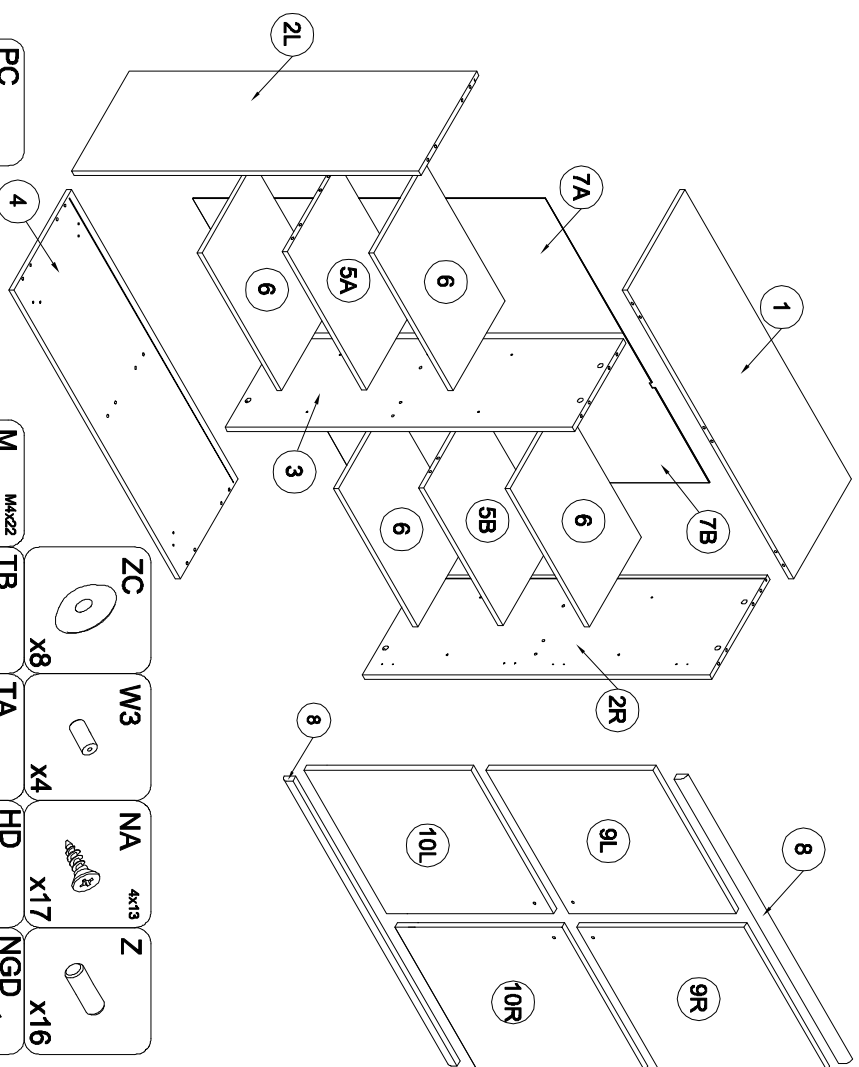

B X26 	A 8x32 X26 	R X8 	H 6.3x13 X16 	N 3x20 X16 	X X16 	C X26 	Z X26
PC X8 	M M4x22 X4 	TB X8 	TA X1 	W3 X4 	NA 4x13 X17 	HD X8 	NGD X4
ZC X8 	W3 X4 	TA X1 	NA 4x13 X17 	Z X16 	NGD X4 	Z X16 	Z X16

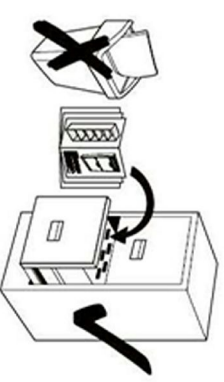
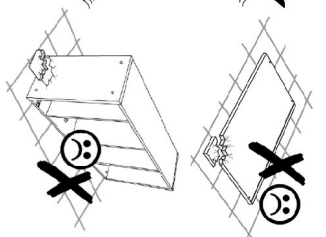
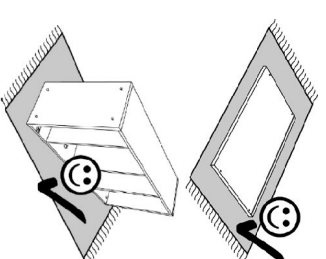

2

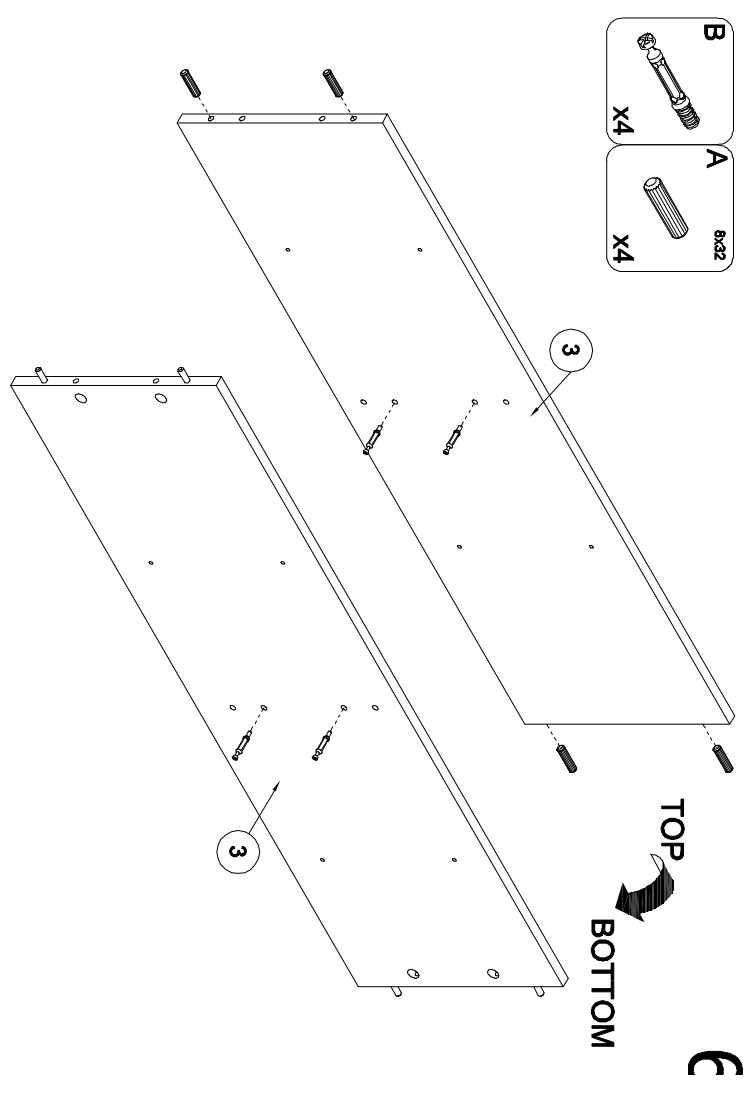
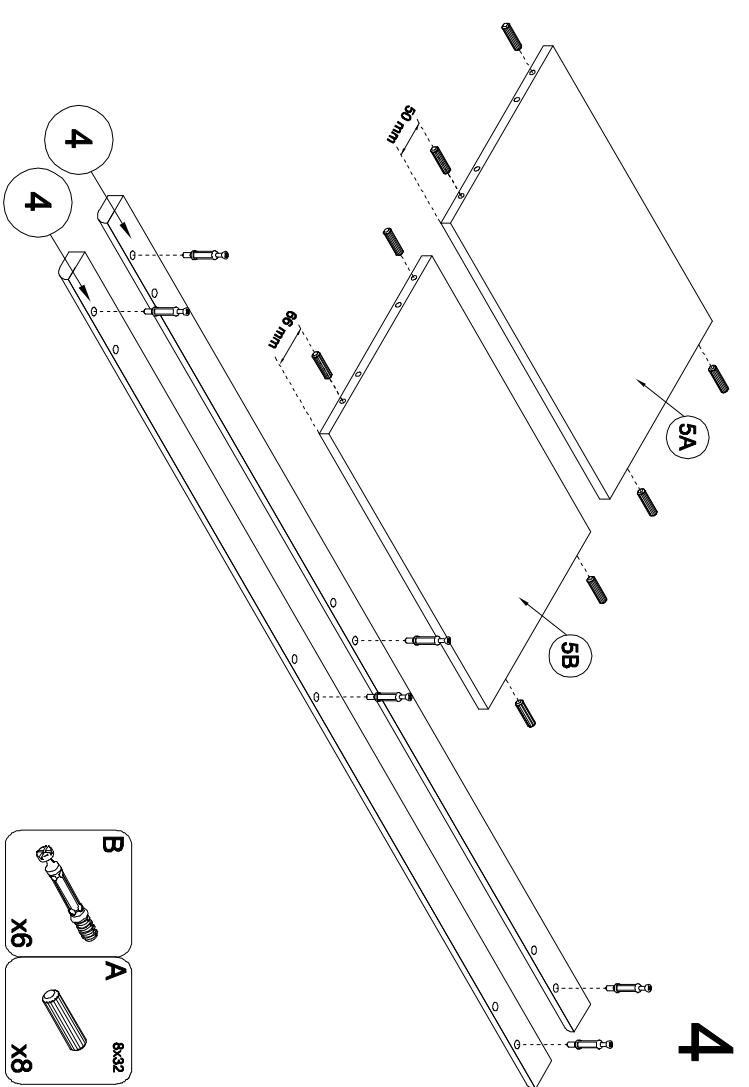
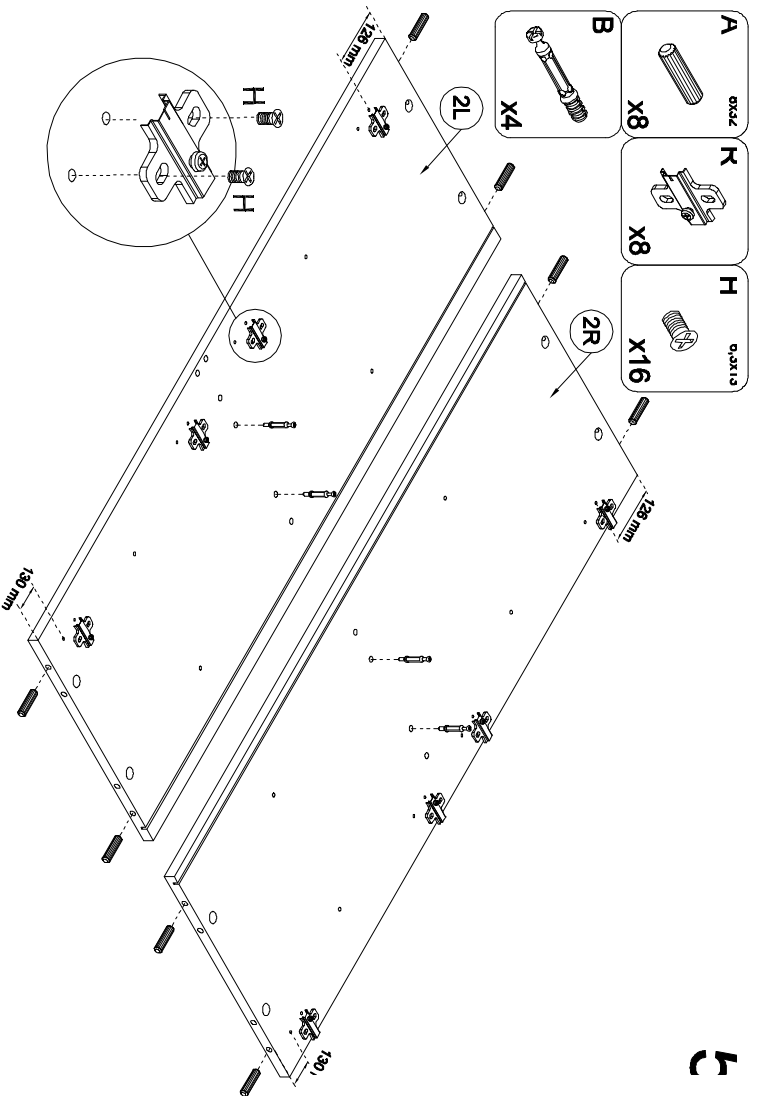
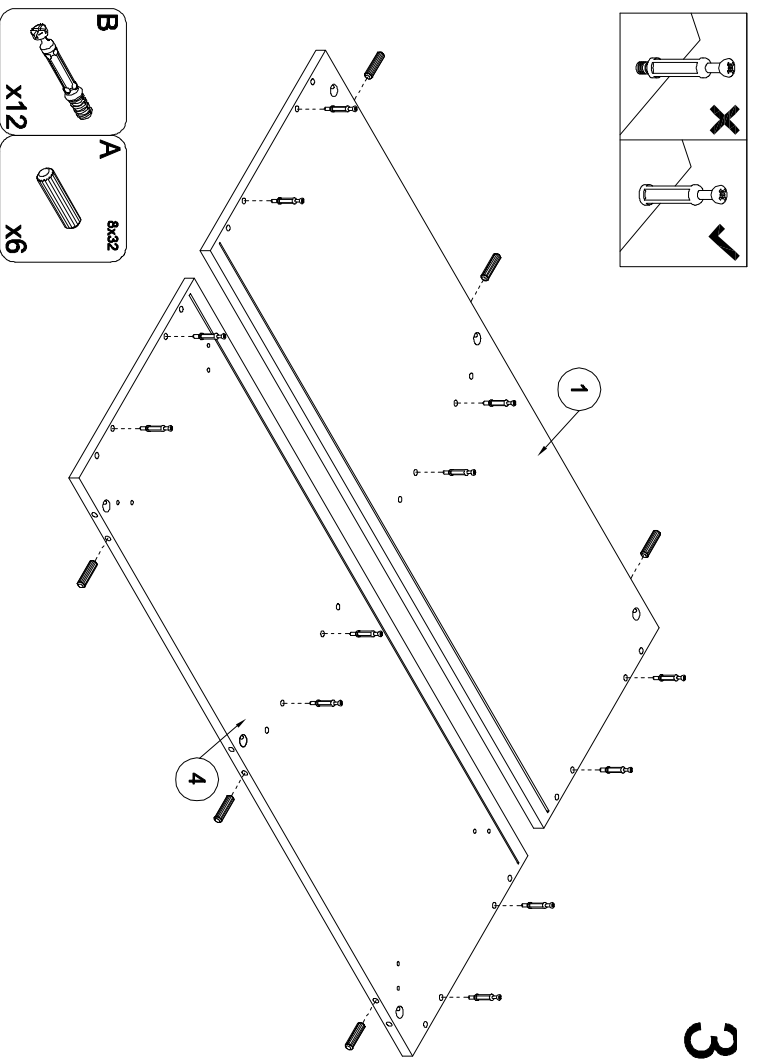
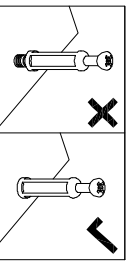

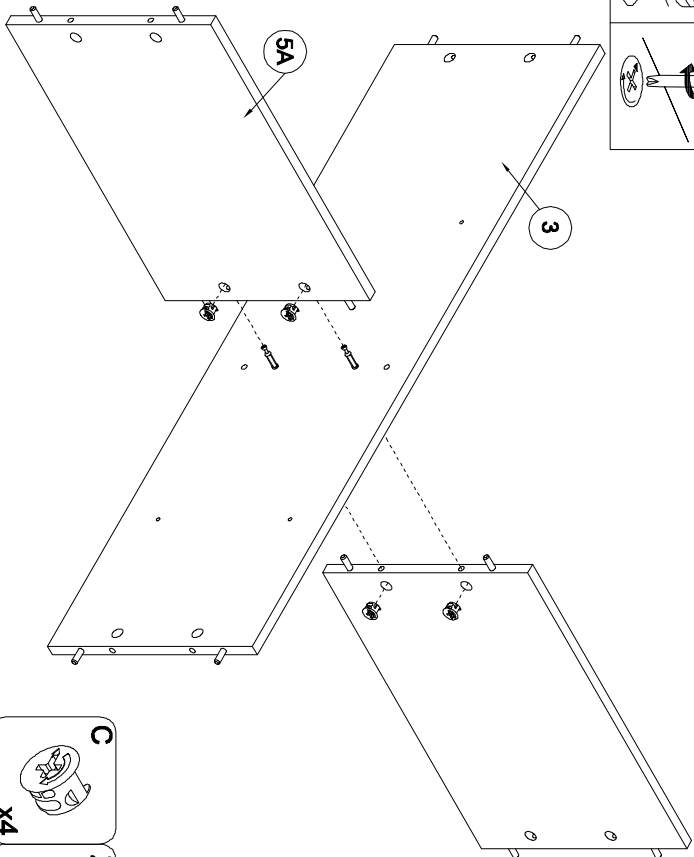
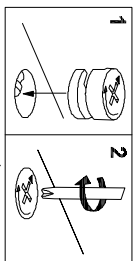

7

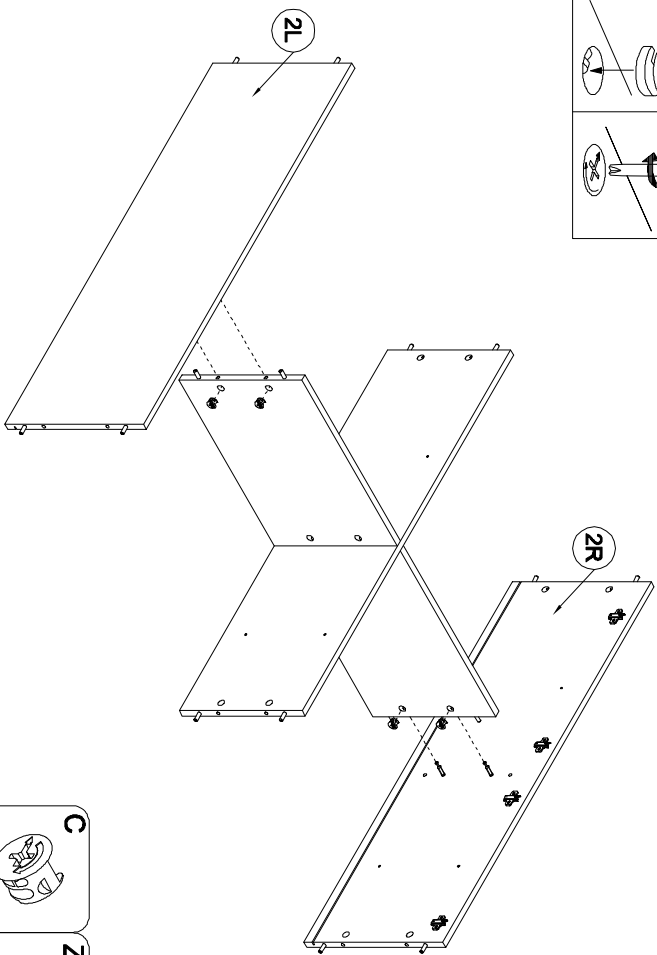
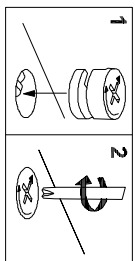
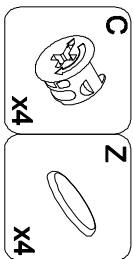

8

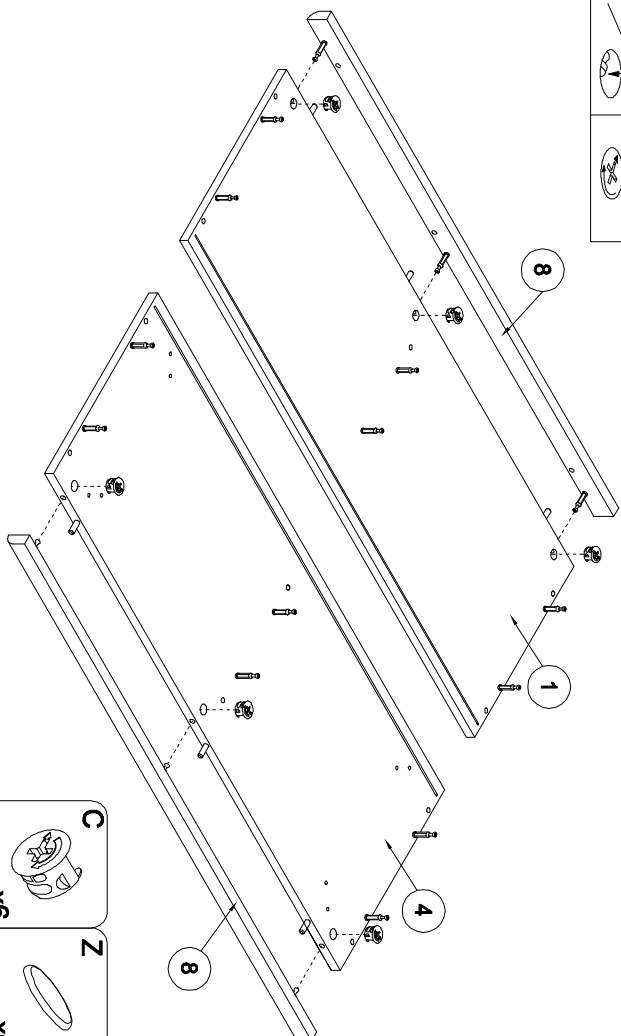
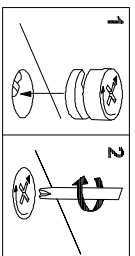
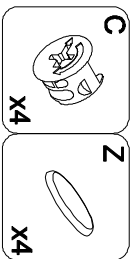

9

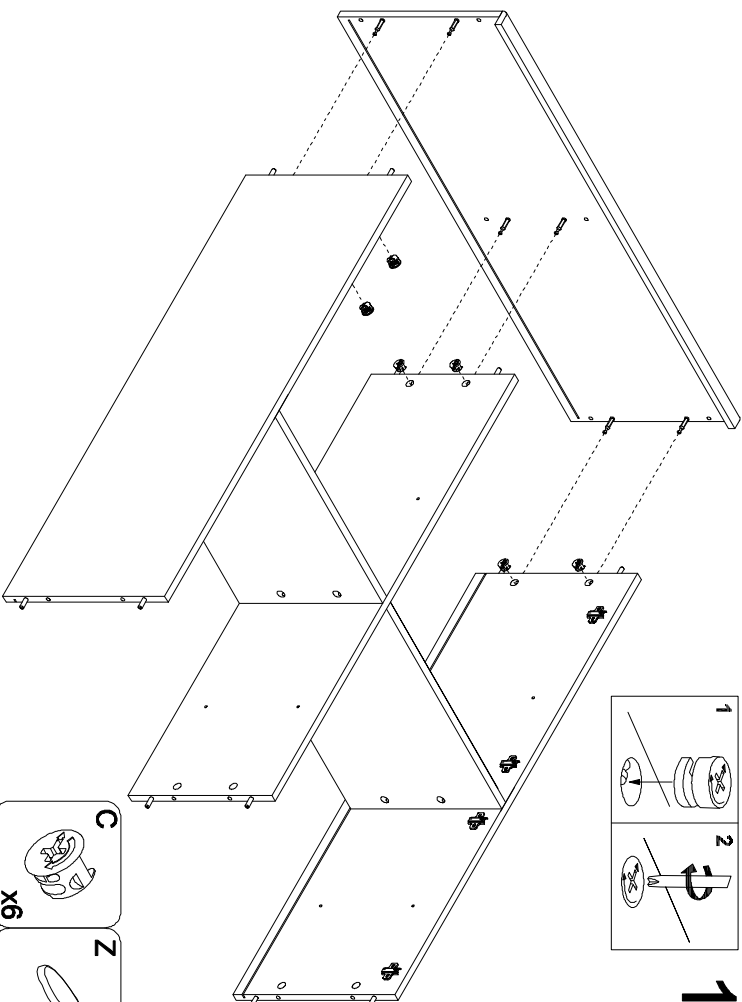
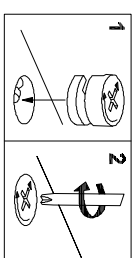
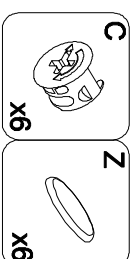

10

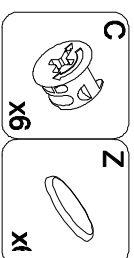

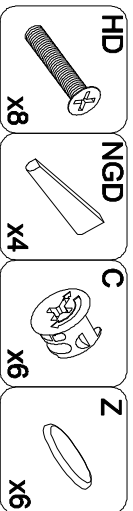
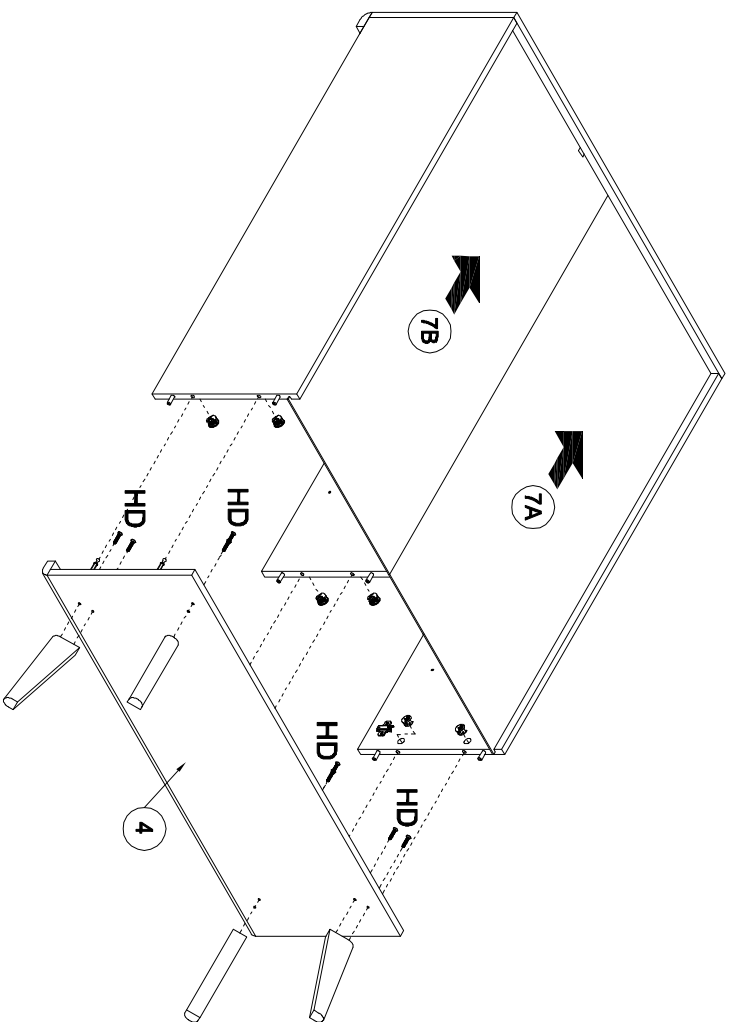
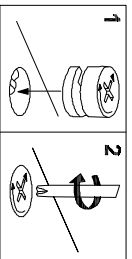

11

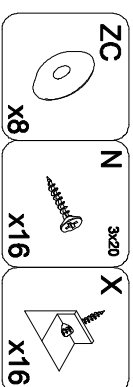
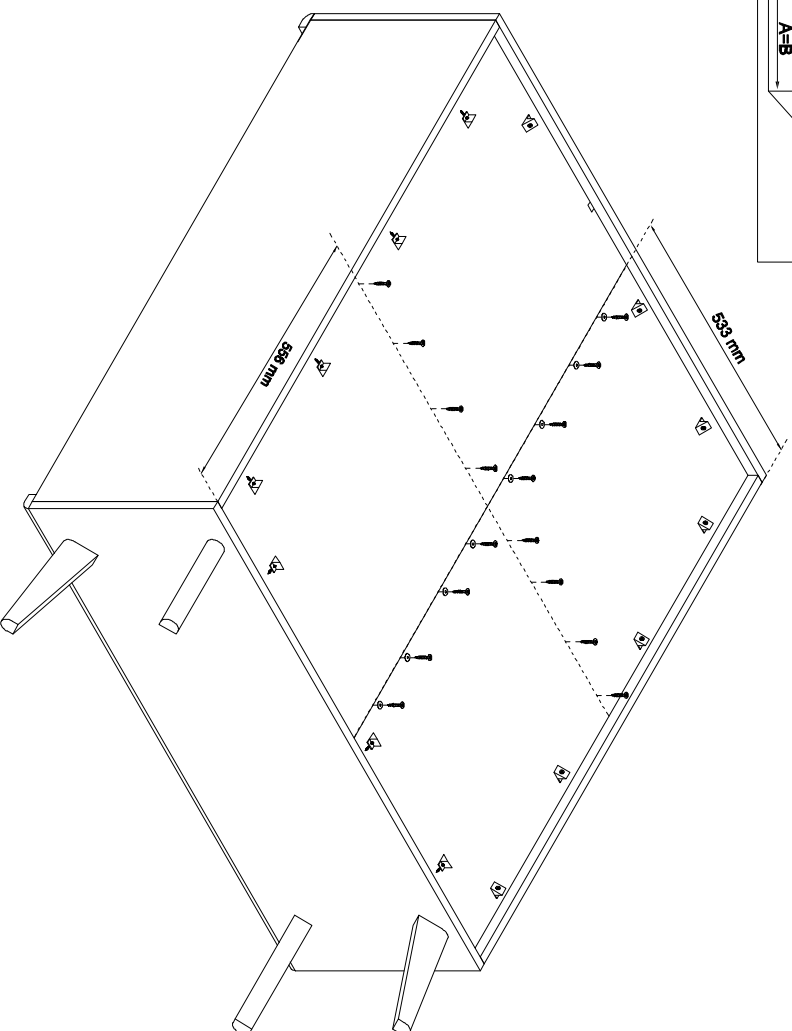
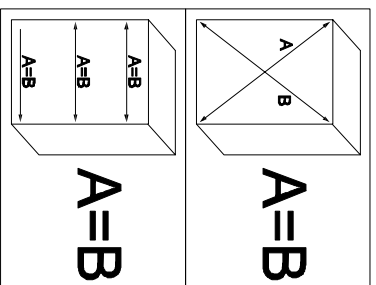



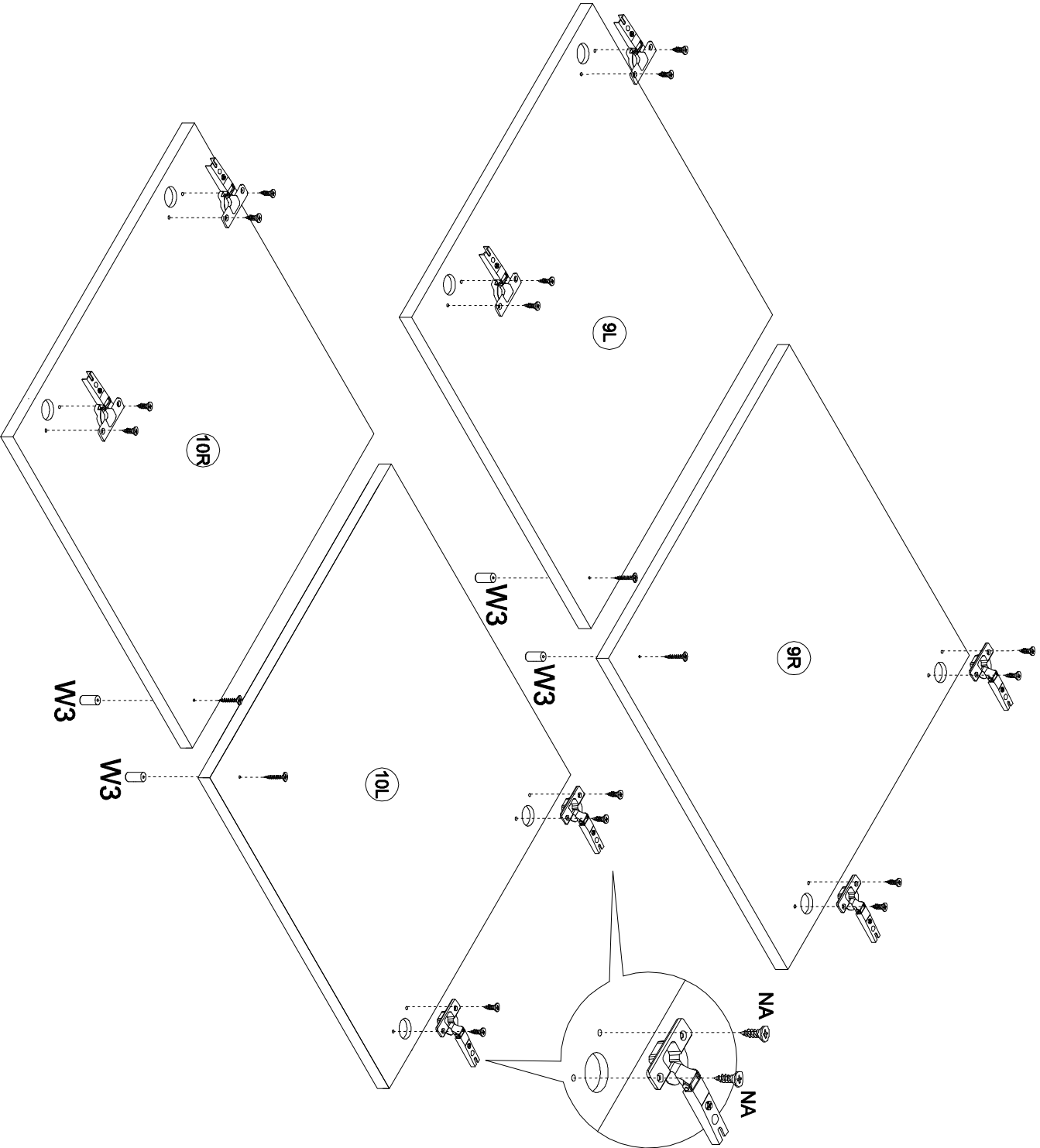

12

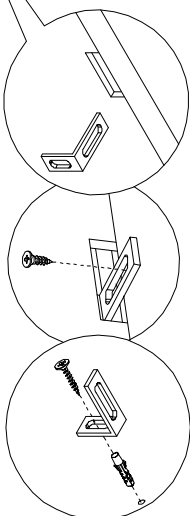
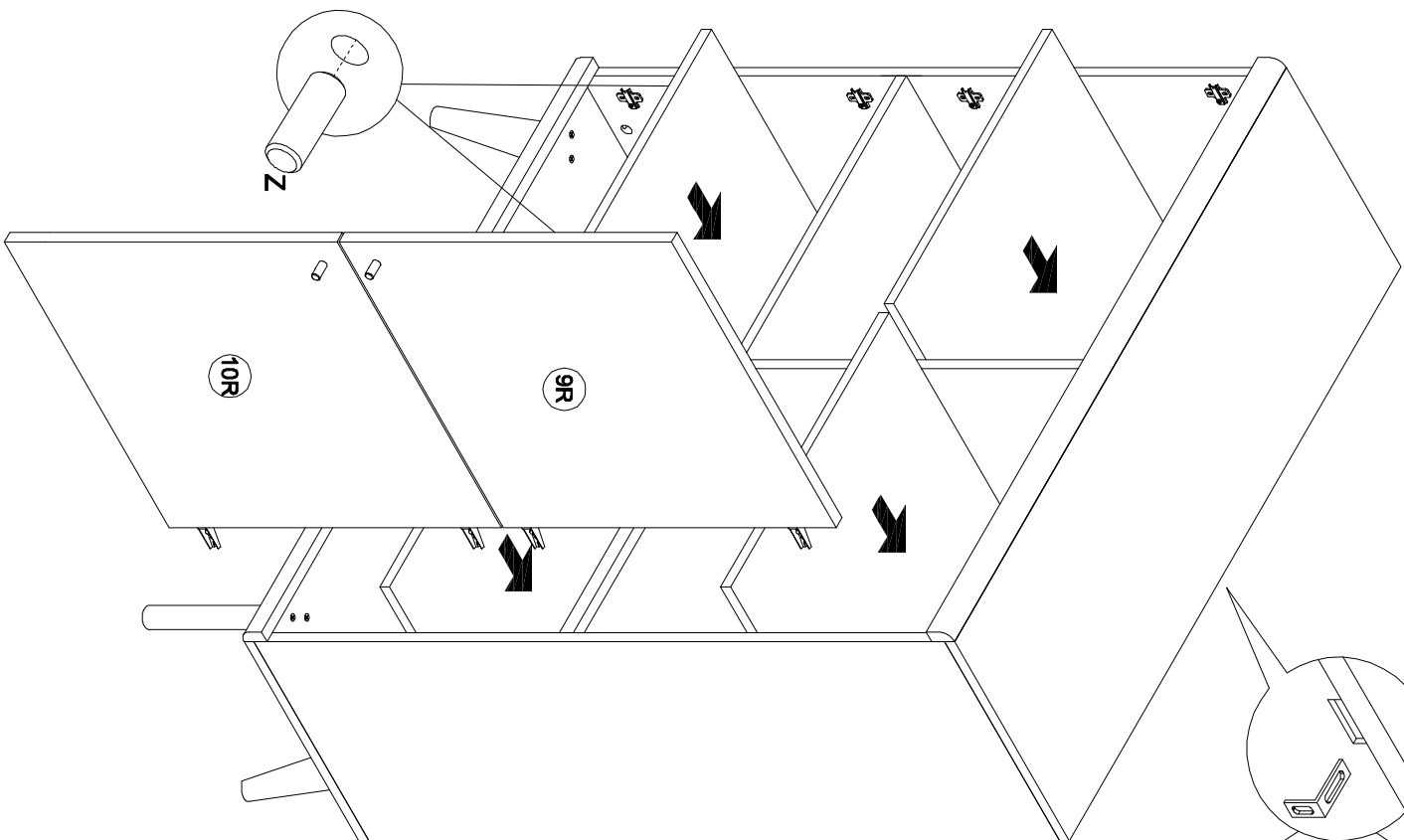
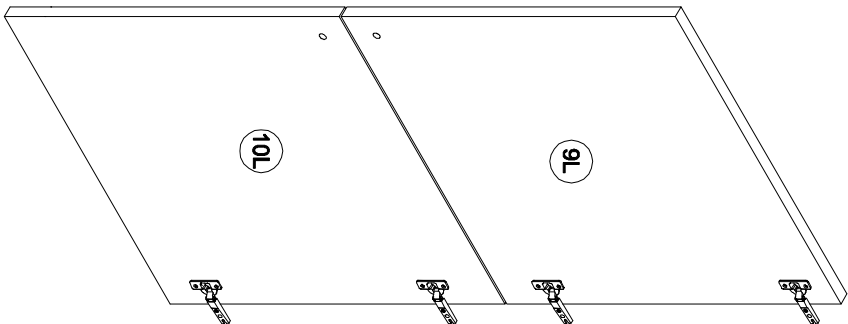
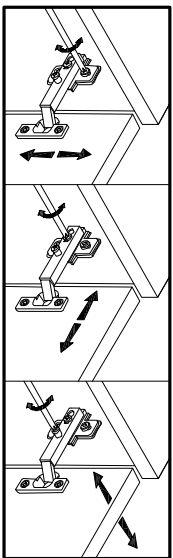
- W3**
X4
- M**
M4x22
X4
- NA**
4x13
X4
- PC**
X16
X8





- x1

TB
- x1

TA
- x1

NA
4x13
- x16

Z