

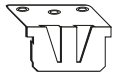

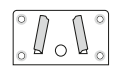

- | | | | |
|--|---|--|---|
| <p>4x20
x 2</p>  <p>(R)</p> | <p>x 8</p>  <p>x 8</p> | <p>x 8</p>  <p>x 8</p> | <p>x 8</p>  <p>(A)</p> |
| <p>x 56</p>  <p>(X)</p> | <p>x 8</p>  <p>(E)</p> | <p>x 32</p>  <p>(D)</p> | |

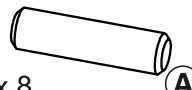

1

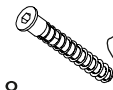

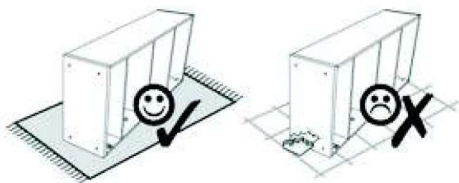
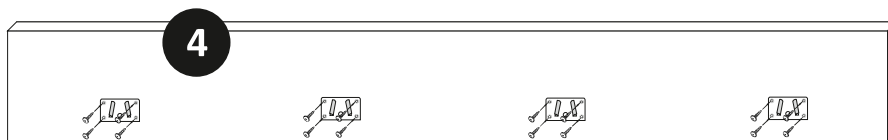
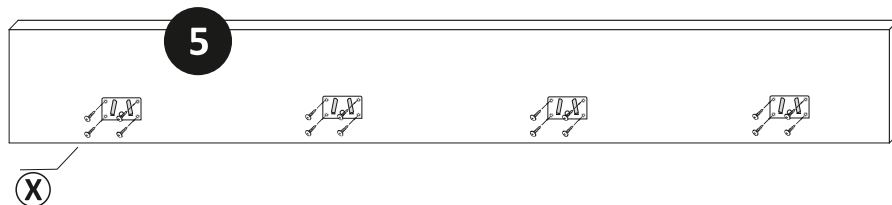
2

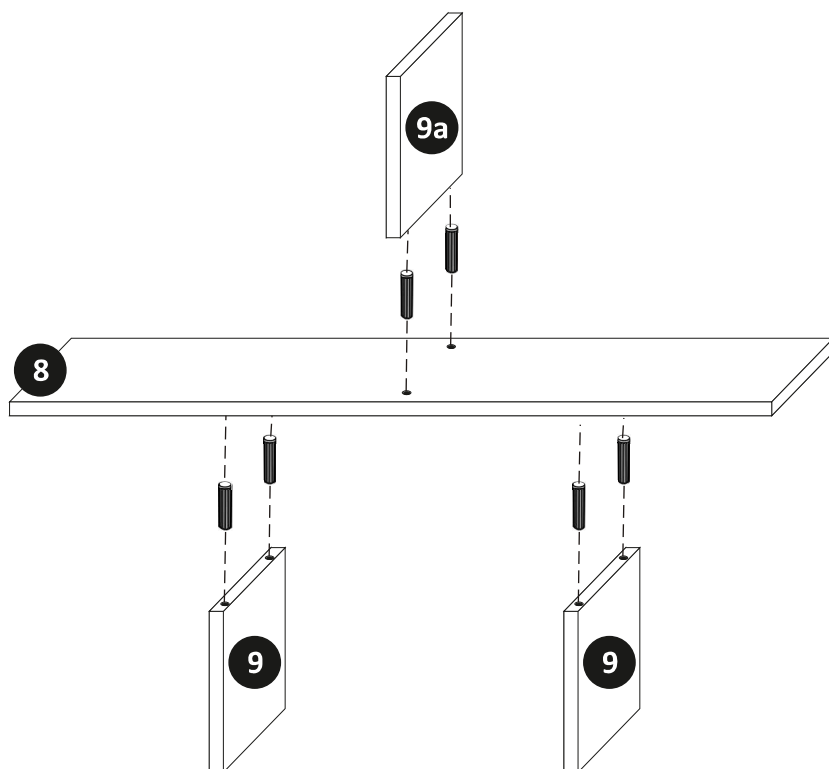

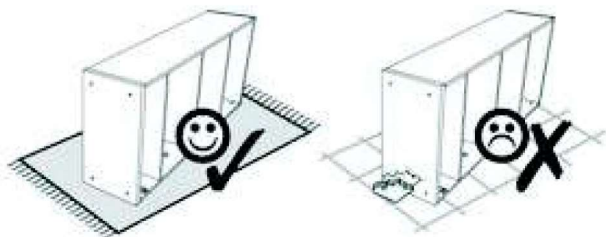

3

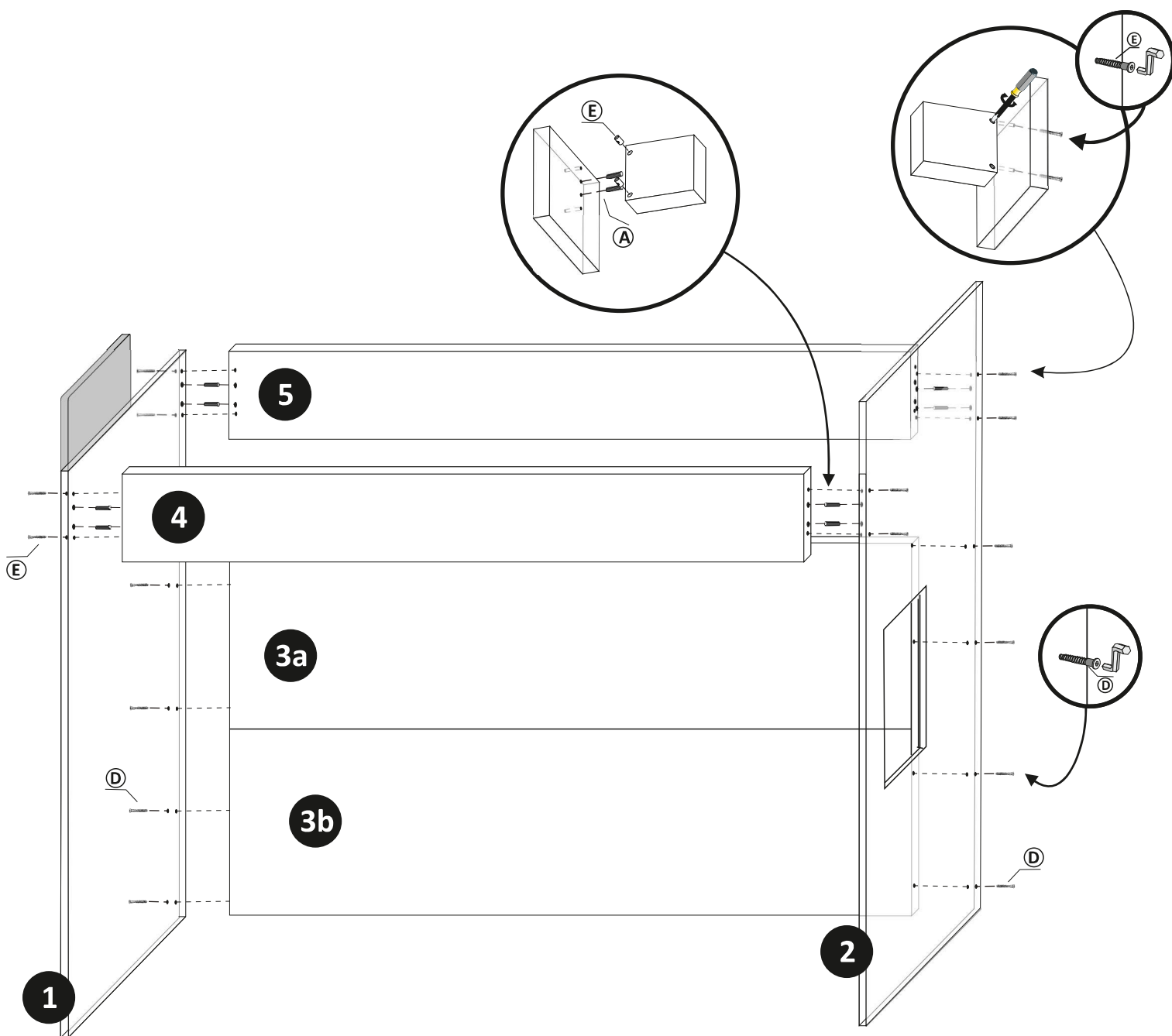

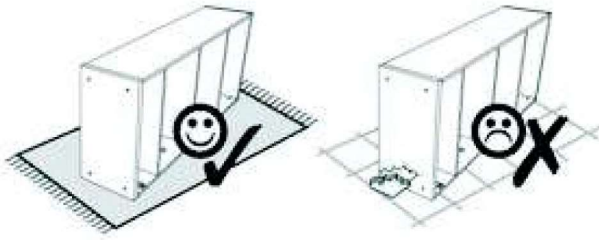

4

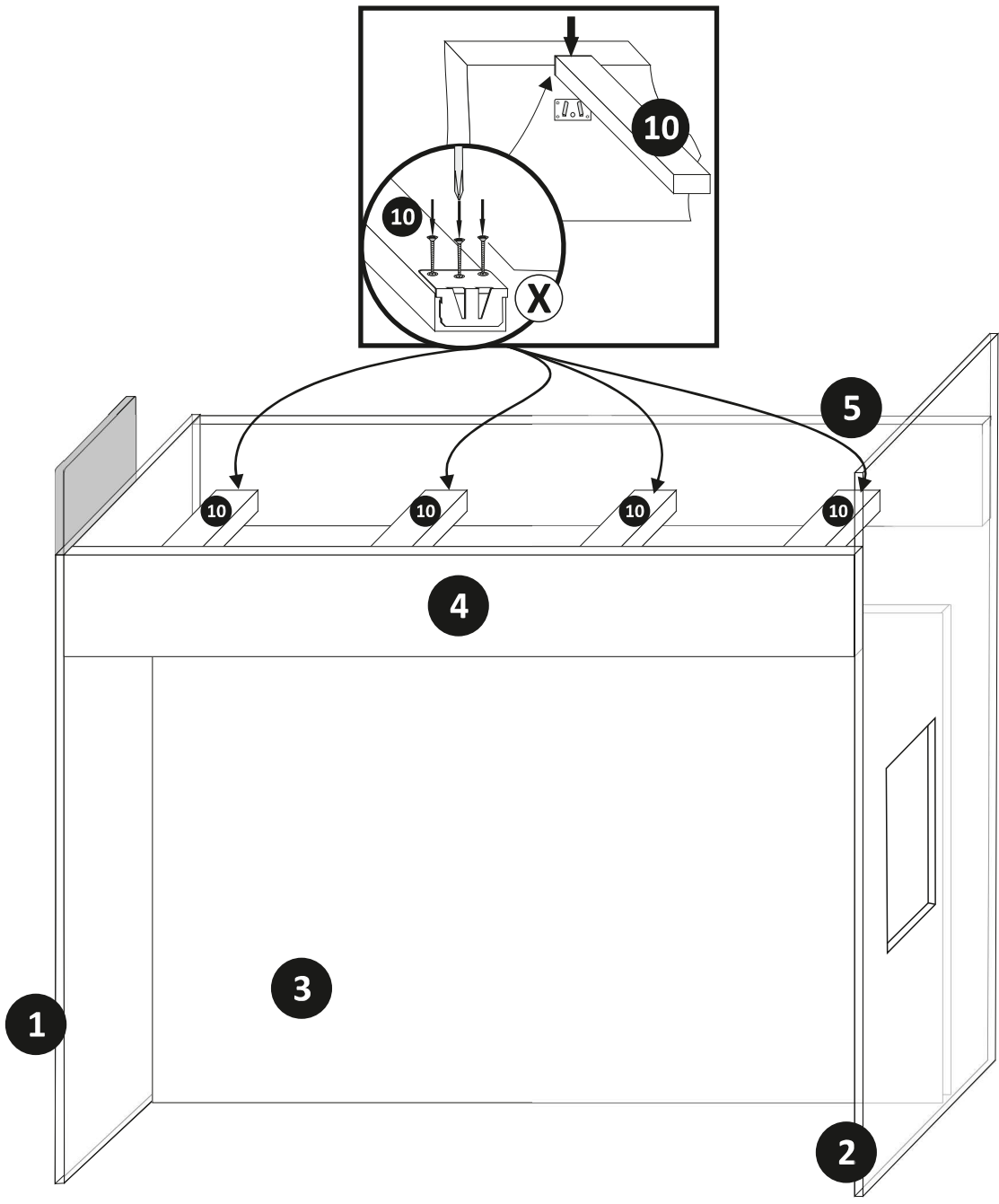

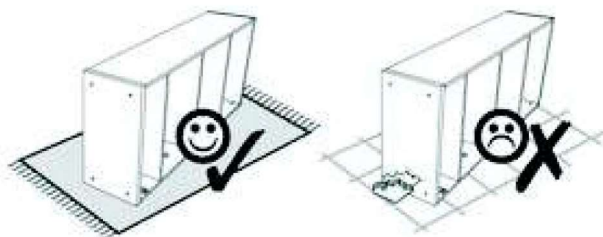

5

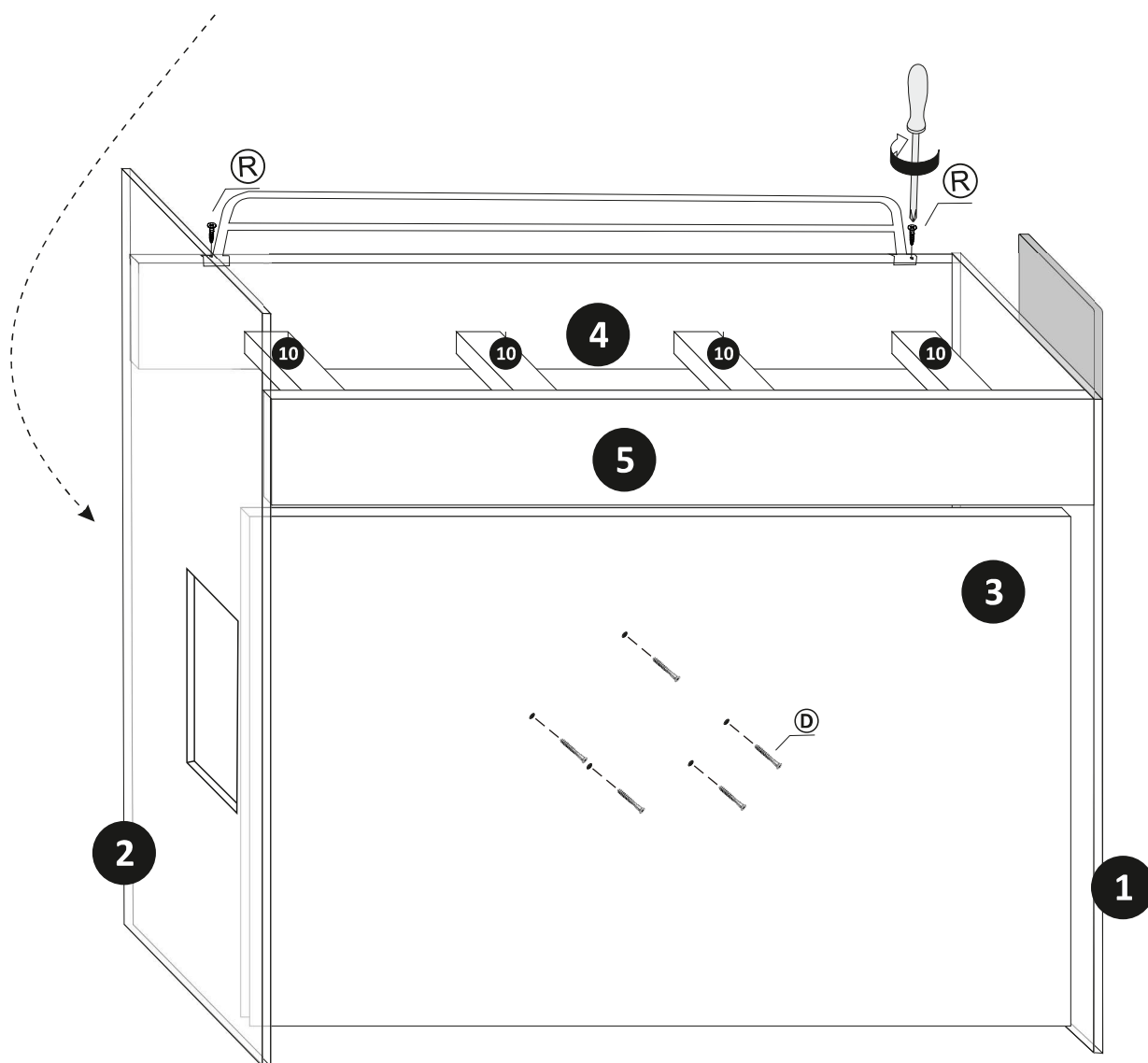
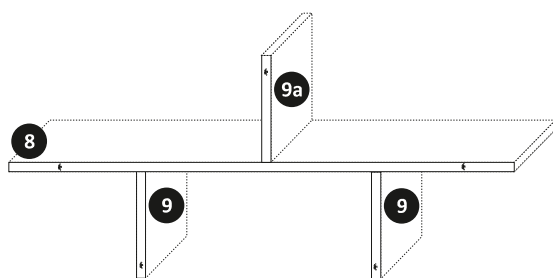

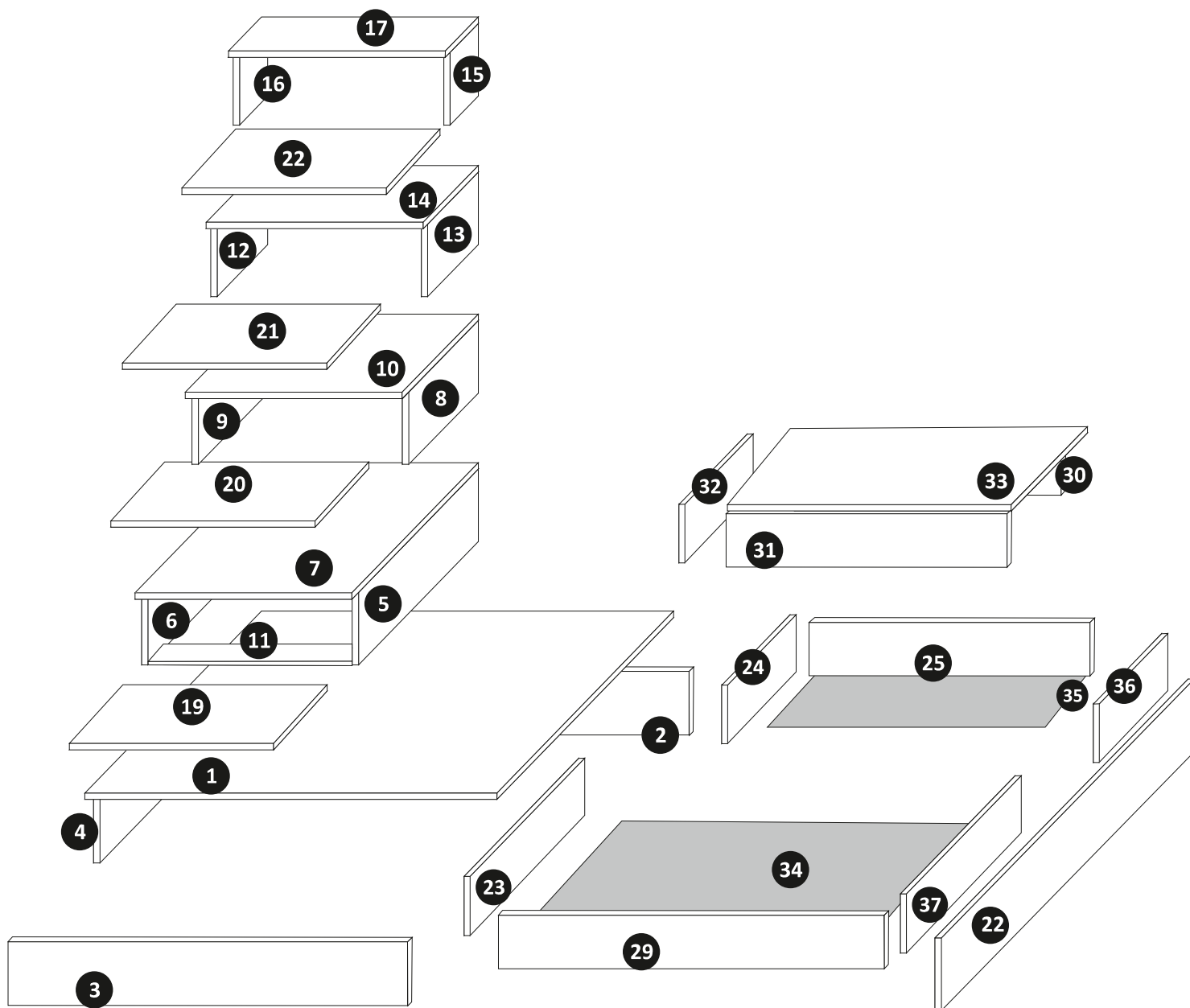

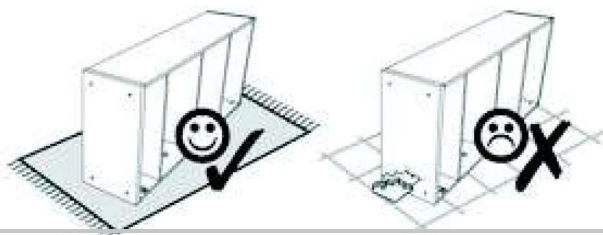

1

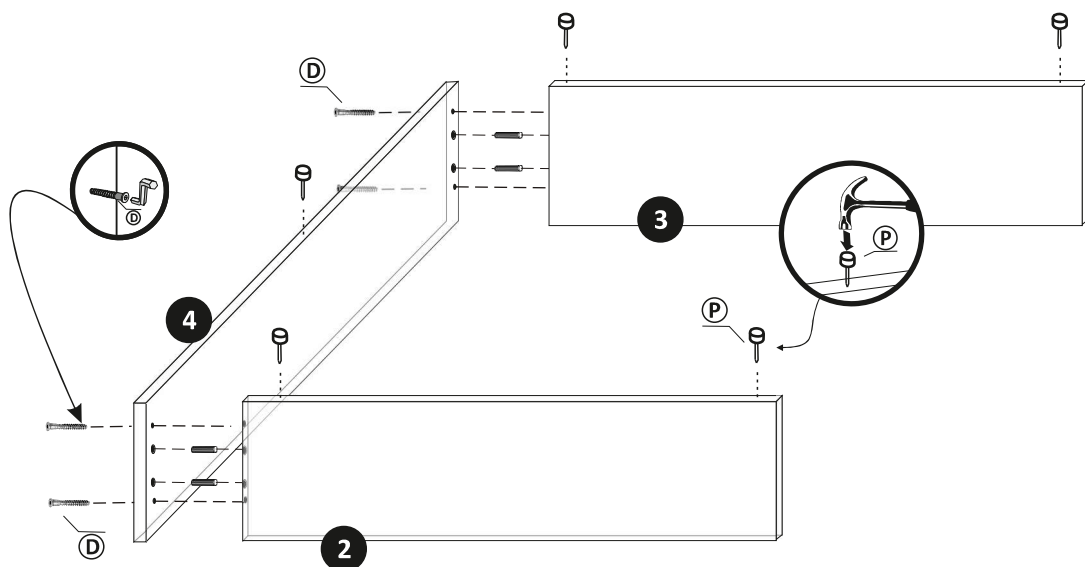

2

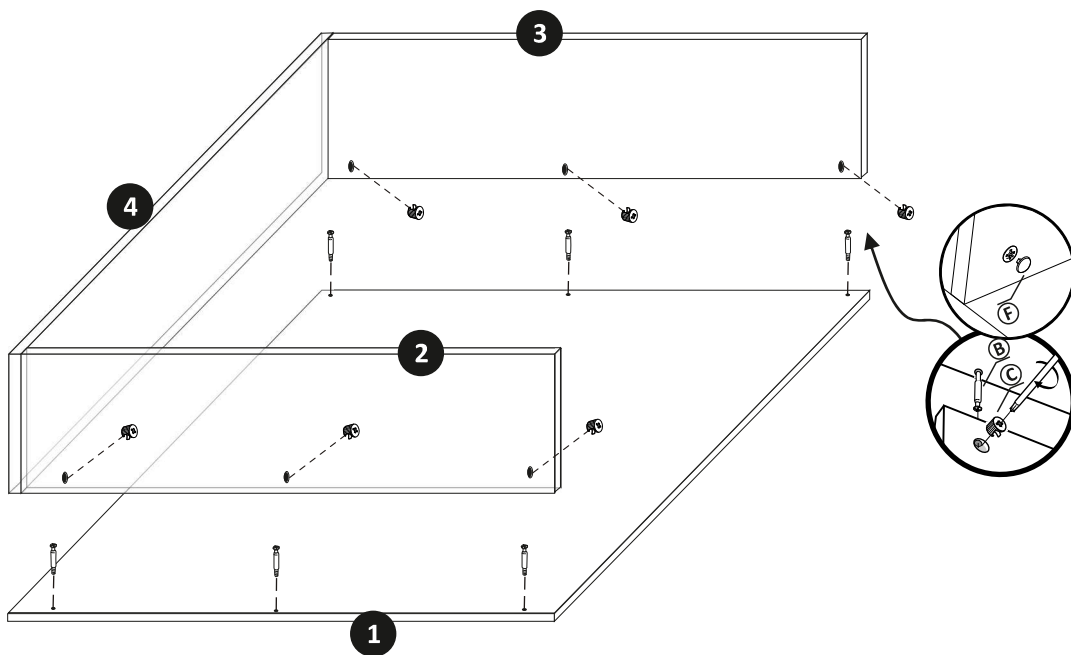

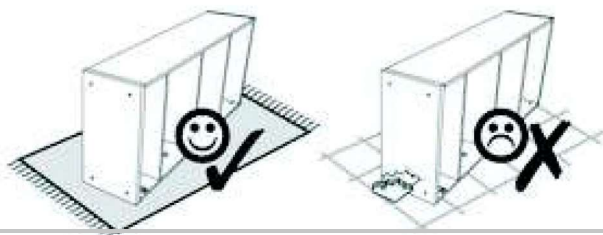

3

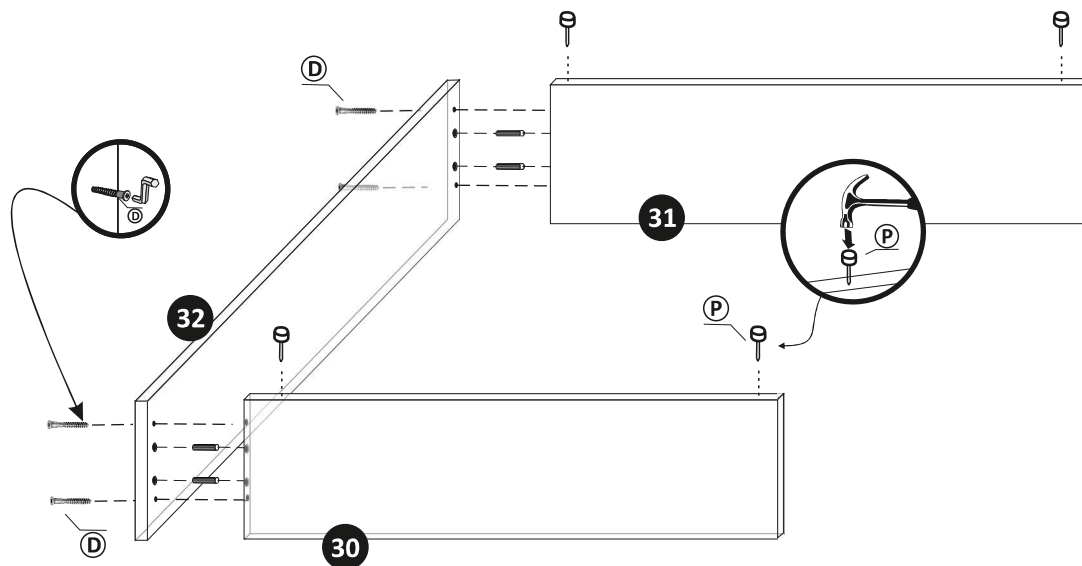

4

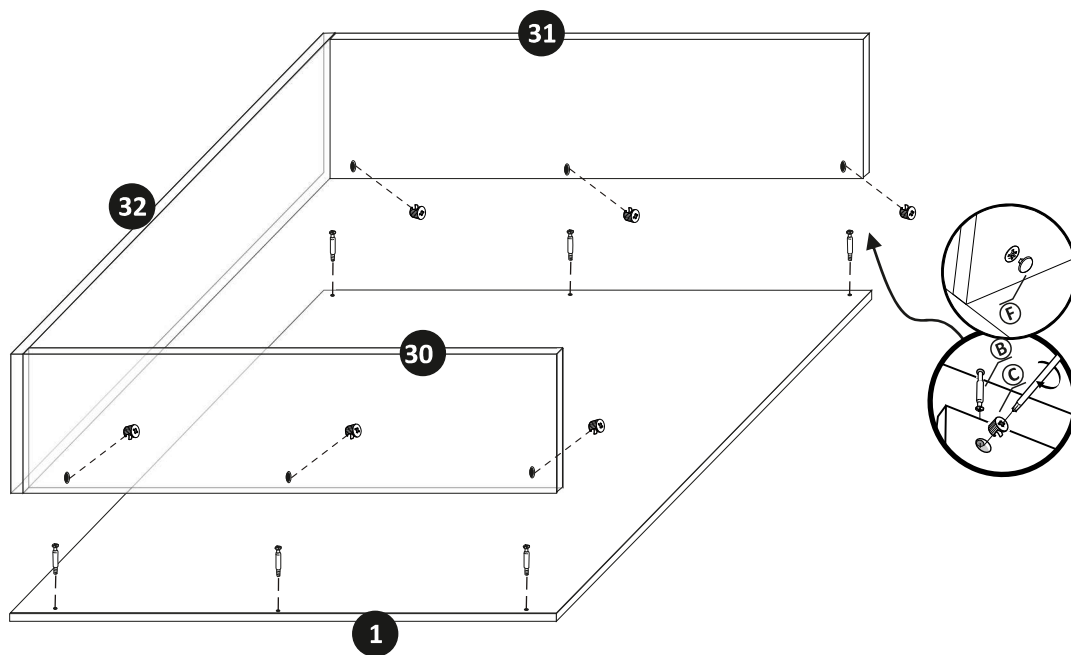

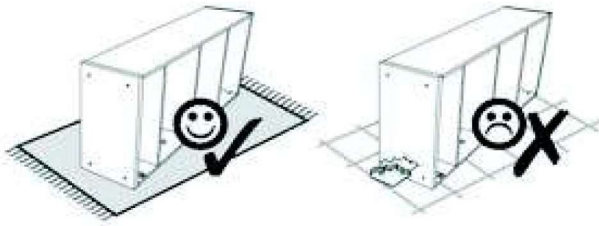

5

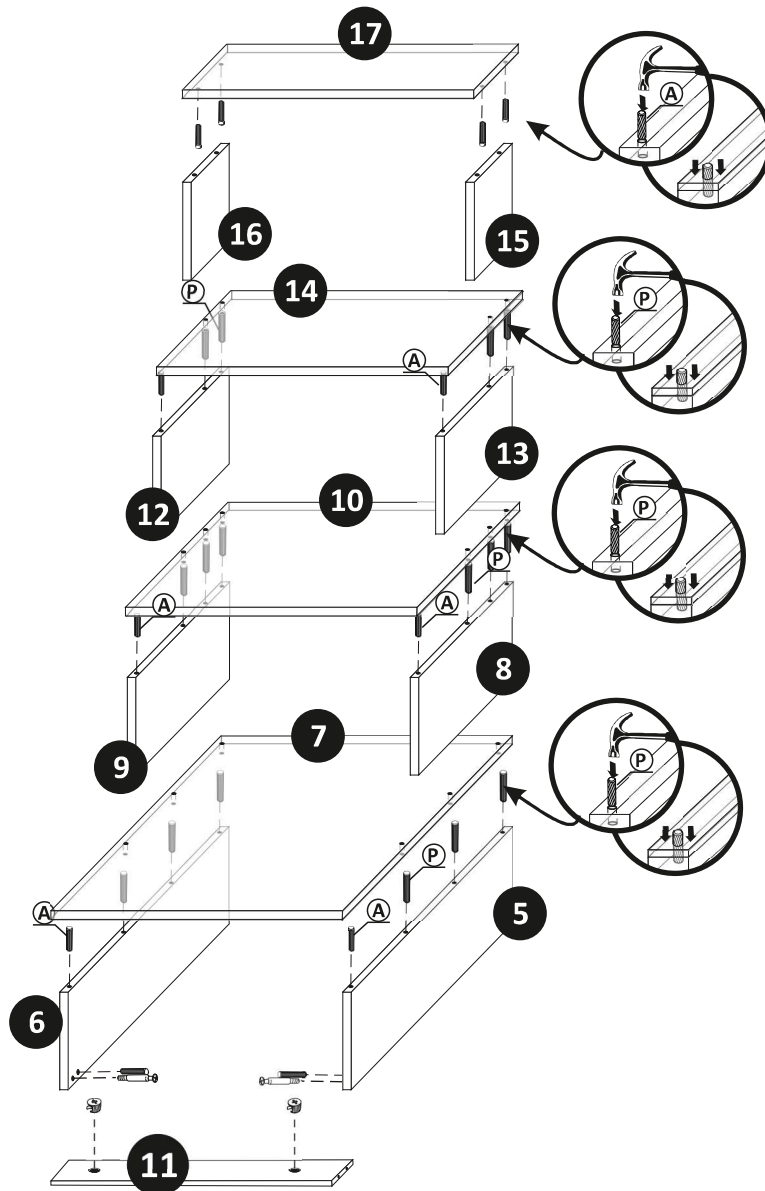

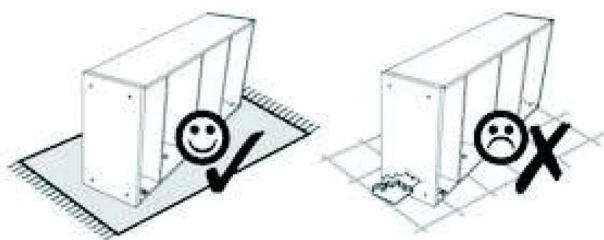

6

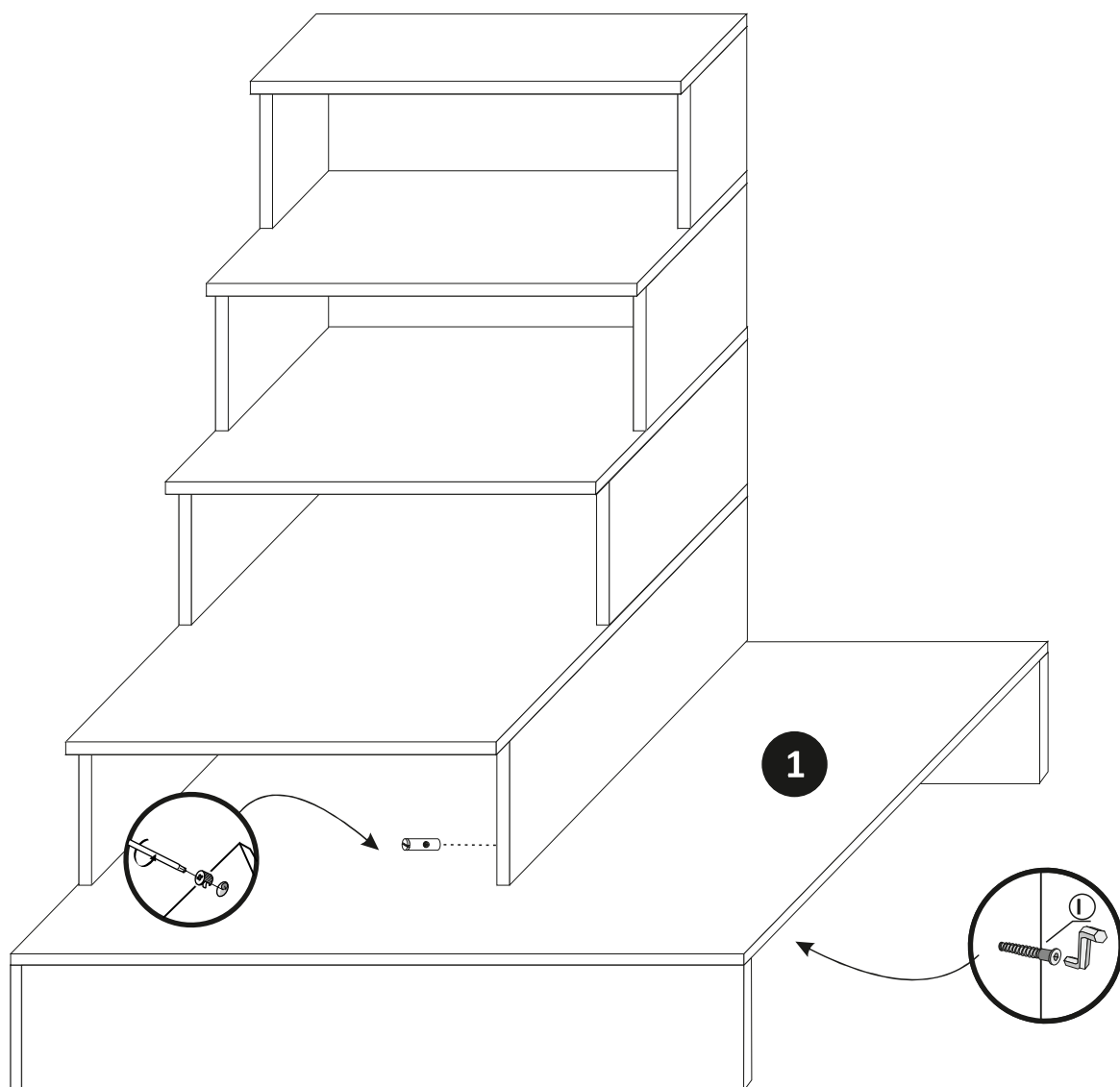

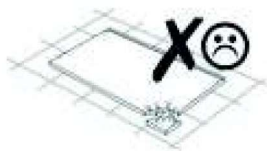
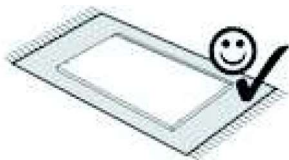

7

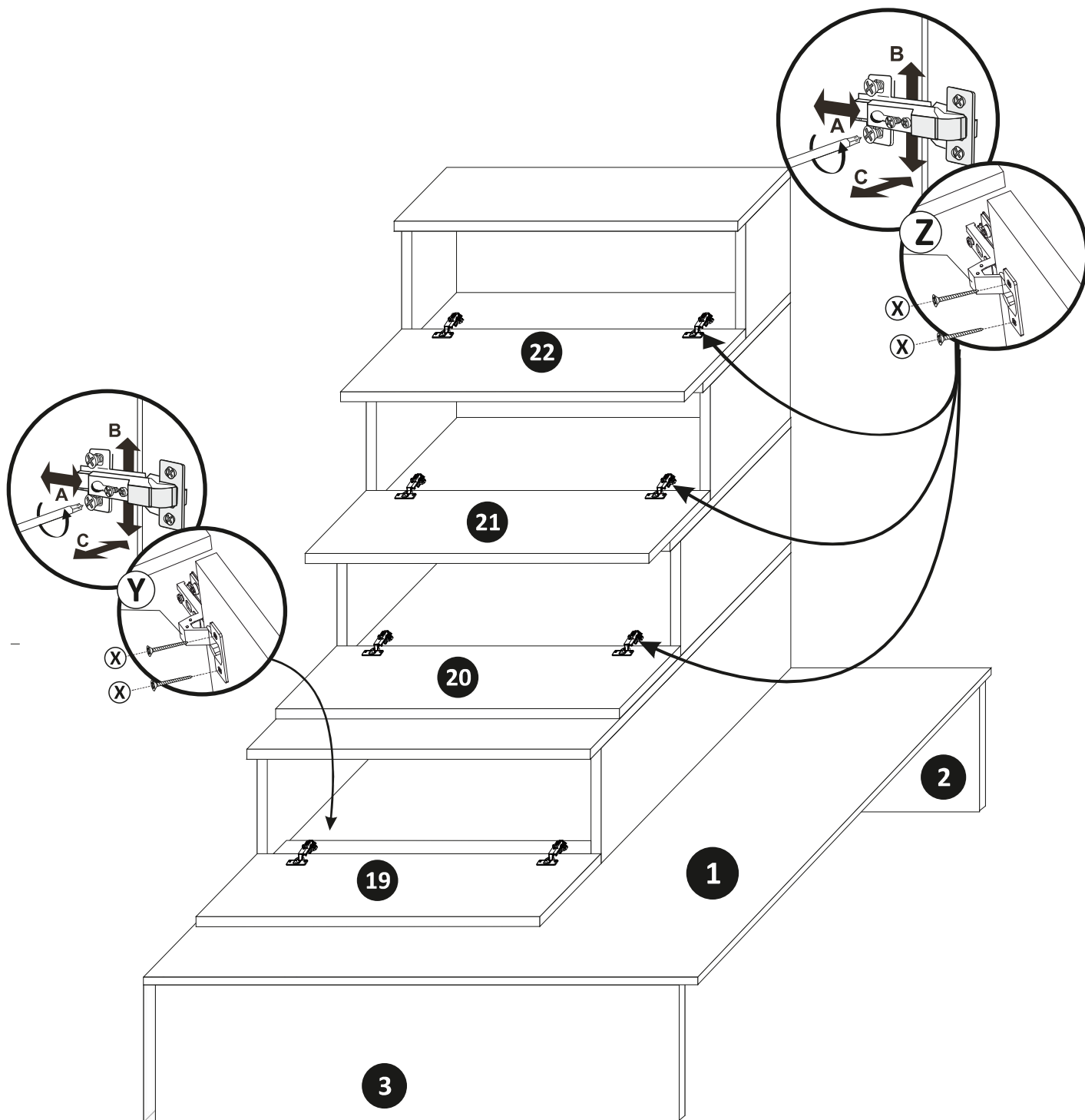

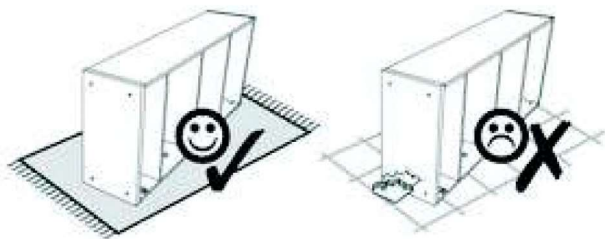

8

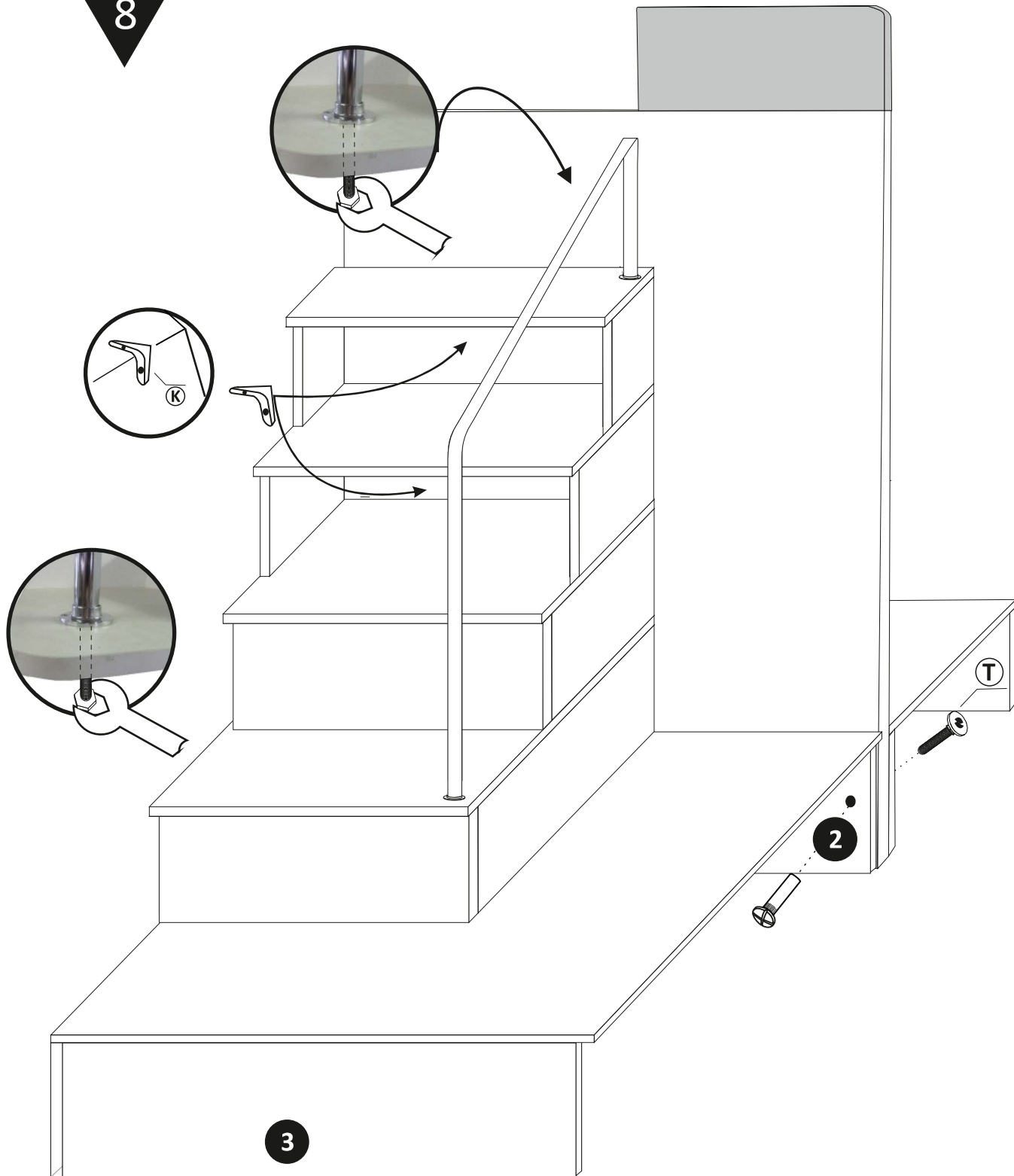

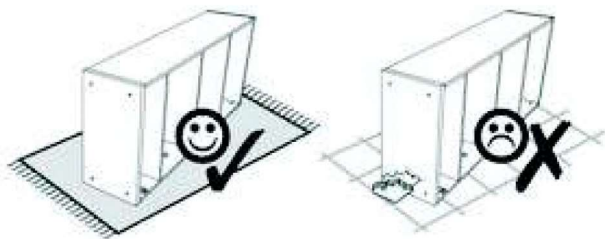

9

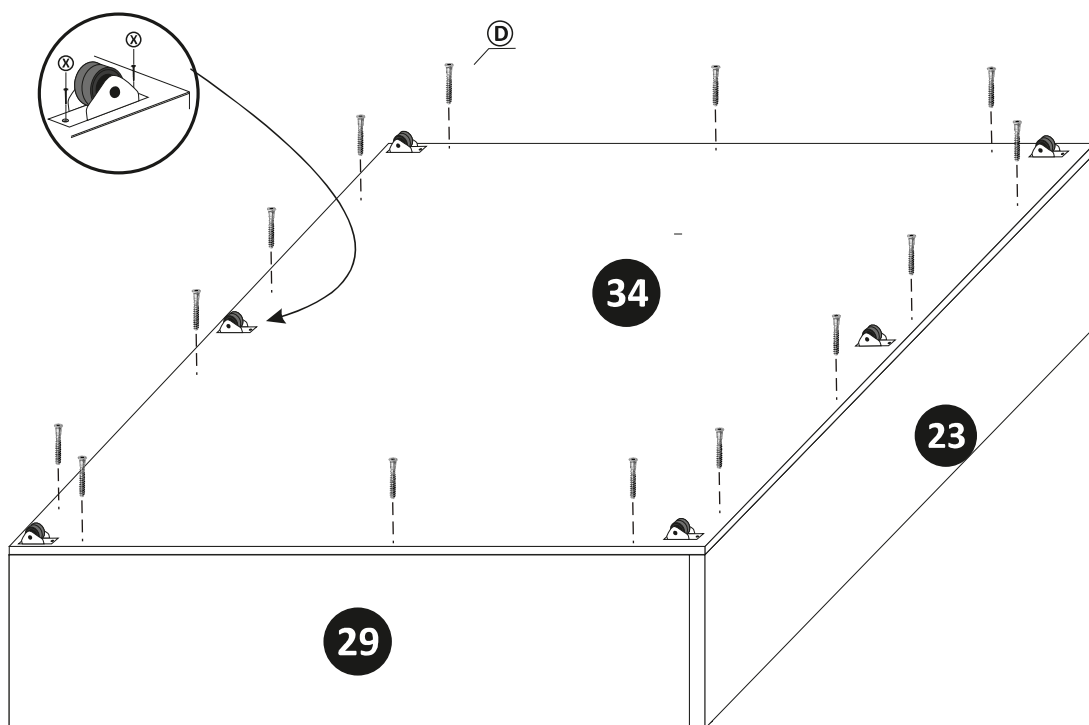
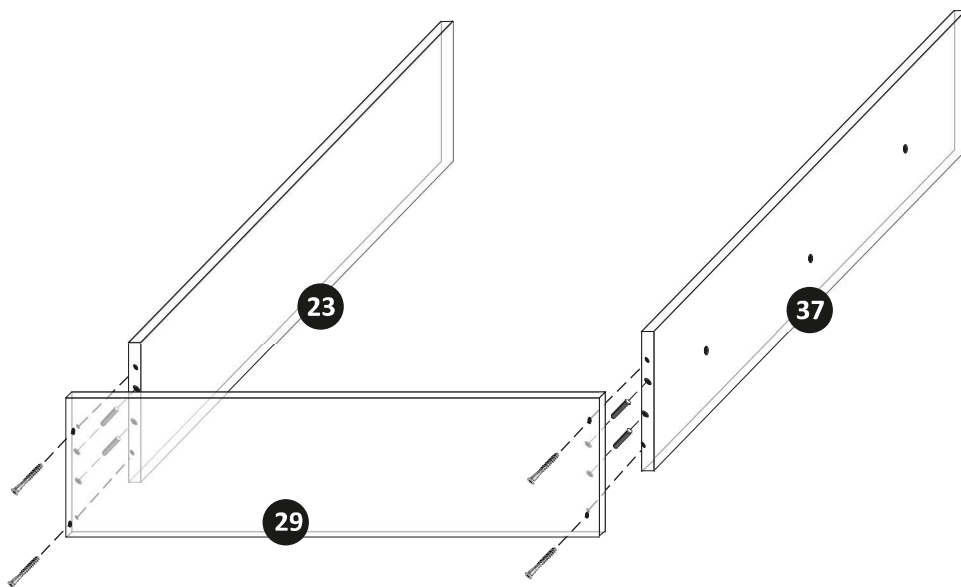

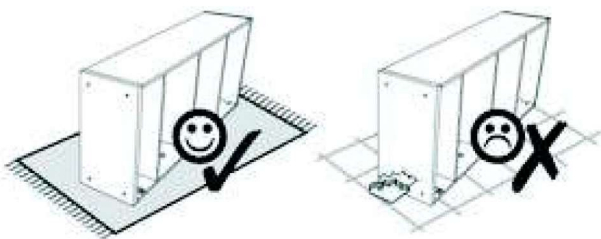

10

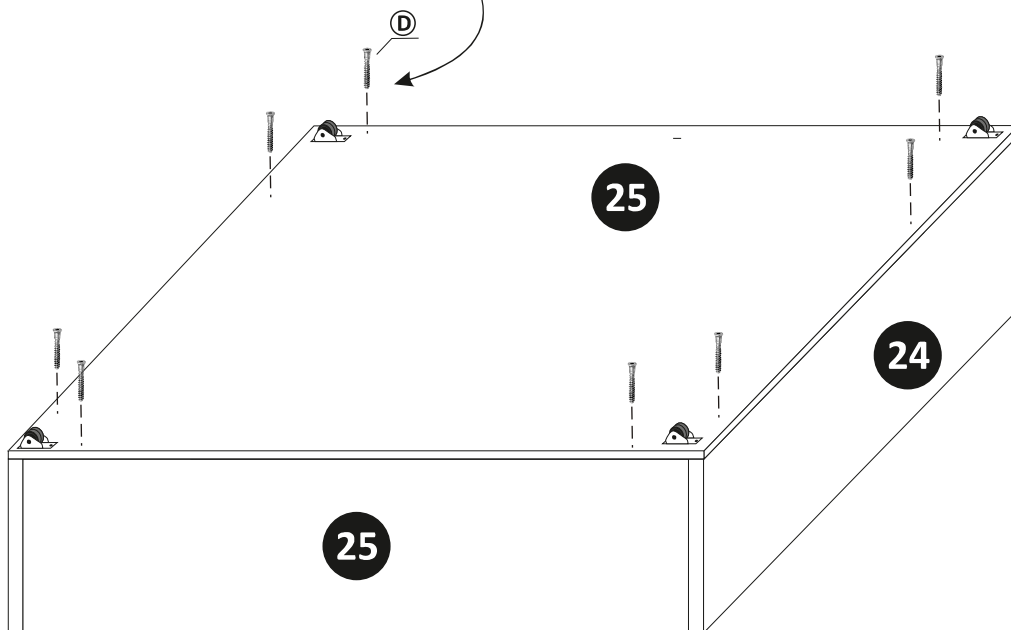
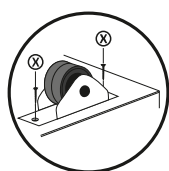
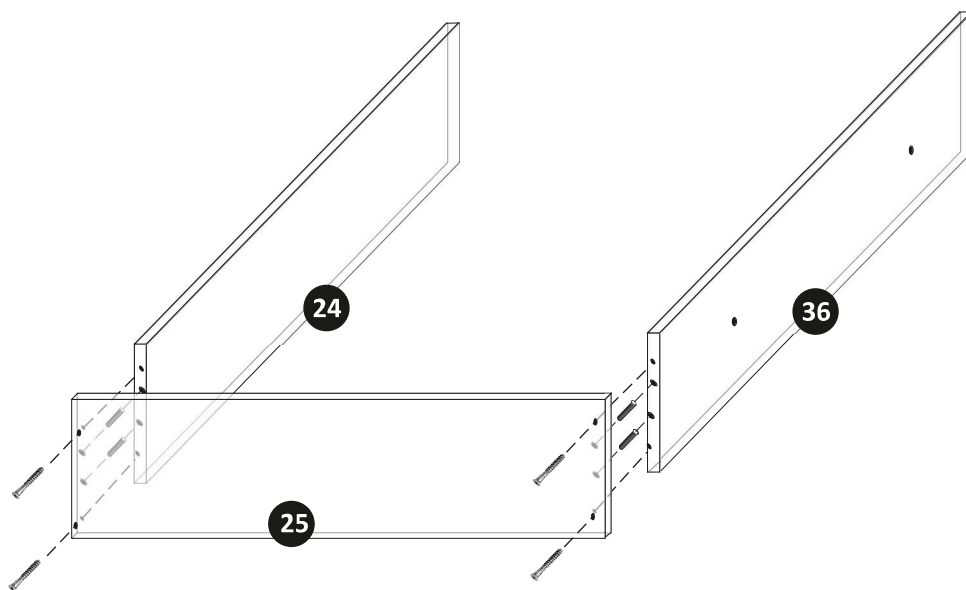

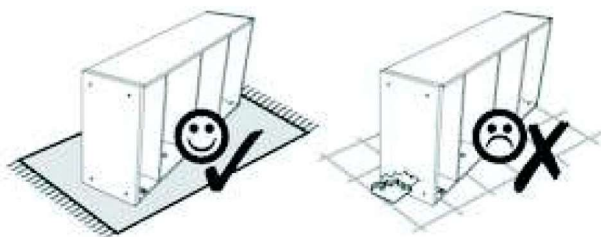



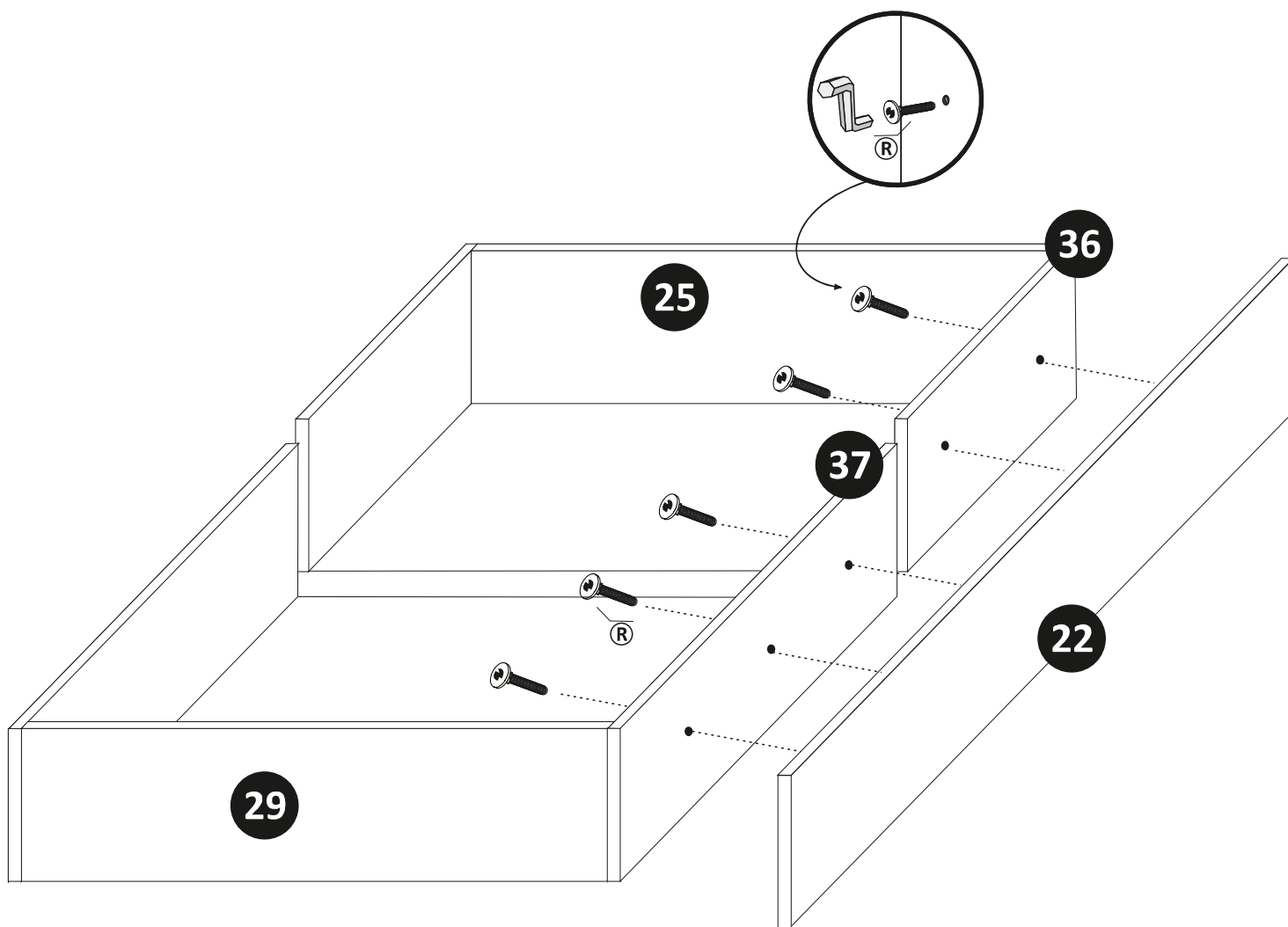

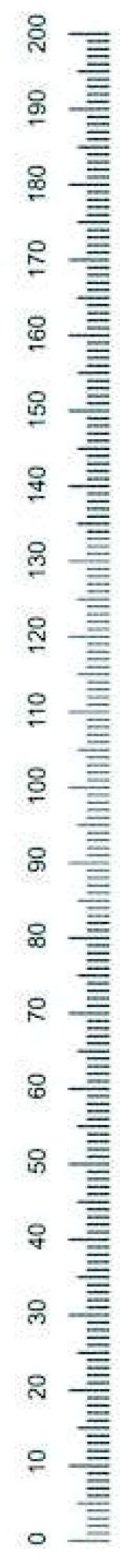
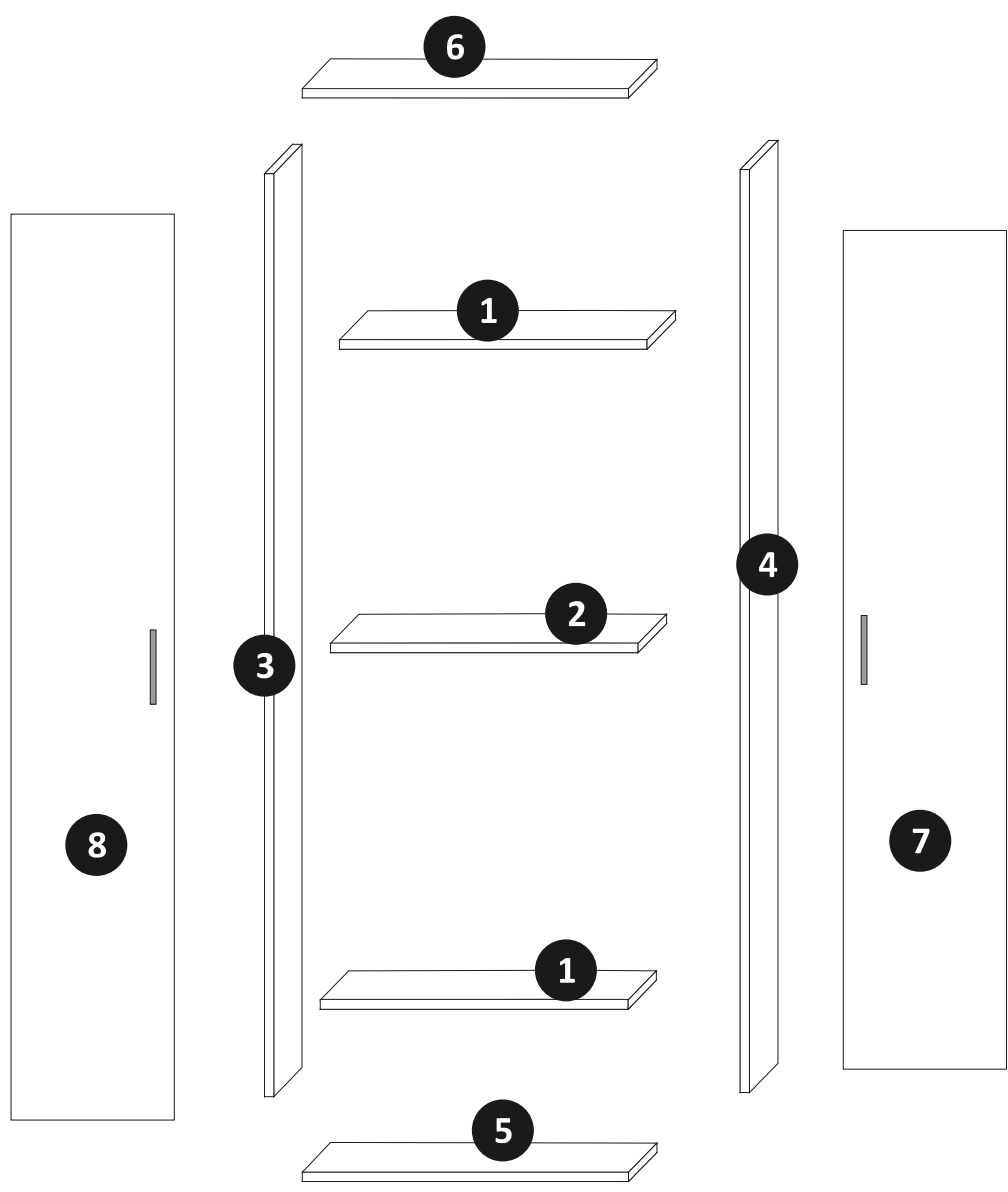



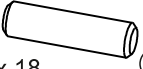
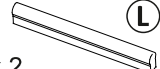

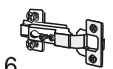
11

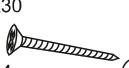

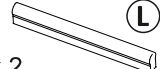

- | | | | | | |
|--|--|--|--|--|---|
|  x 12 |  x 8 |  x 18 |  x 2 |  x 12 |  x 6 |
|  x 12 |  x 4 |  x 12 |  x 2 |  x 12 | |

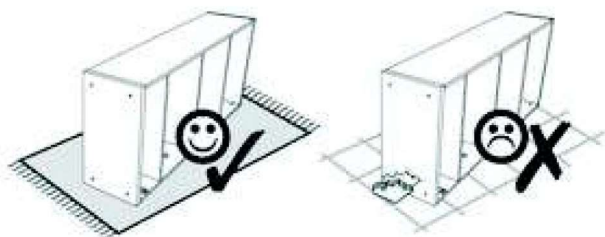

1

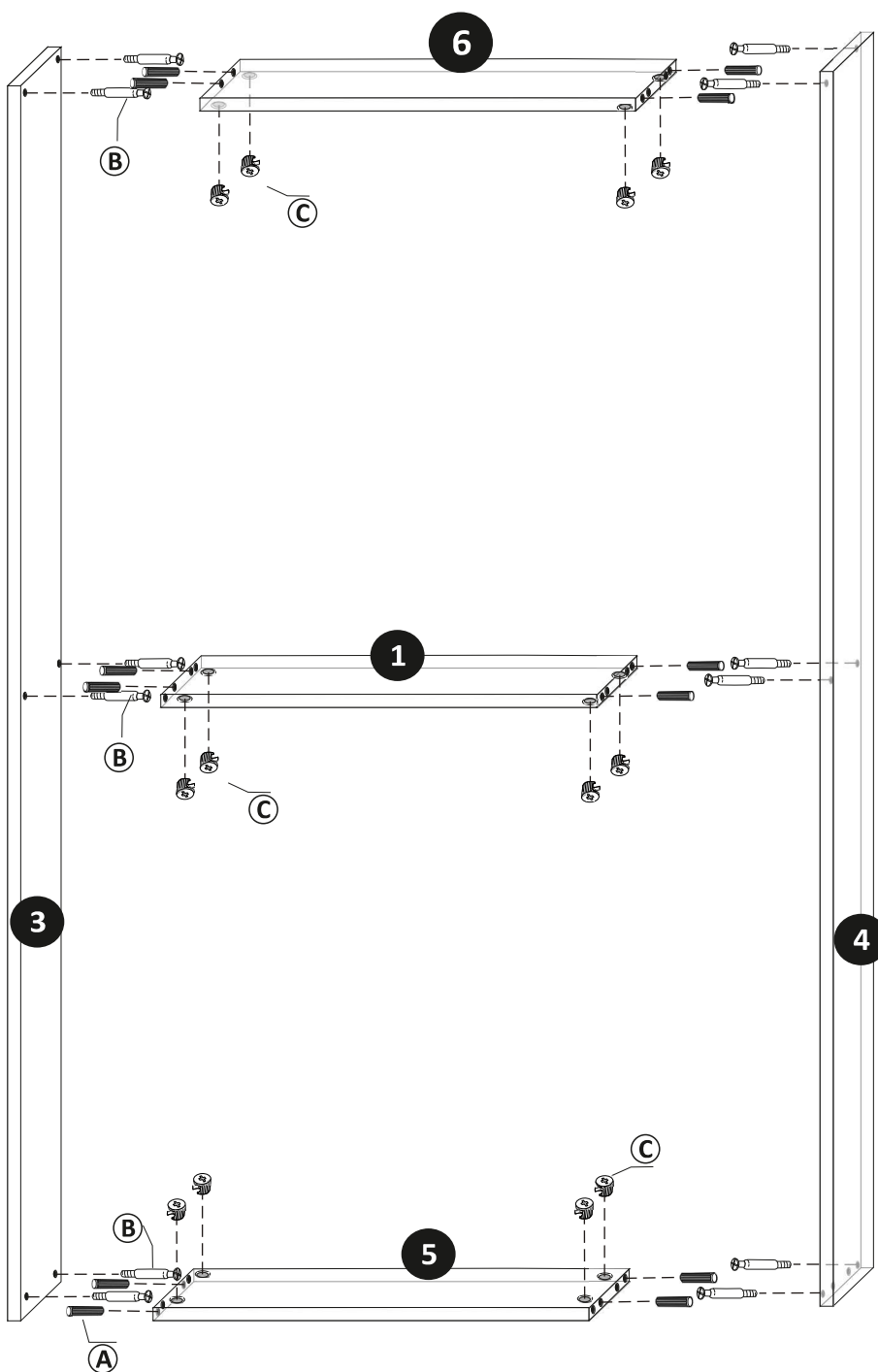

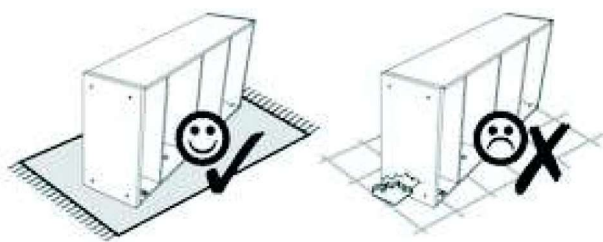



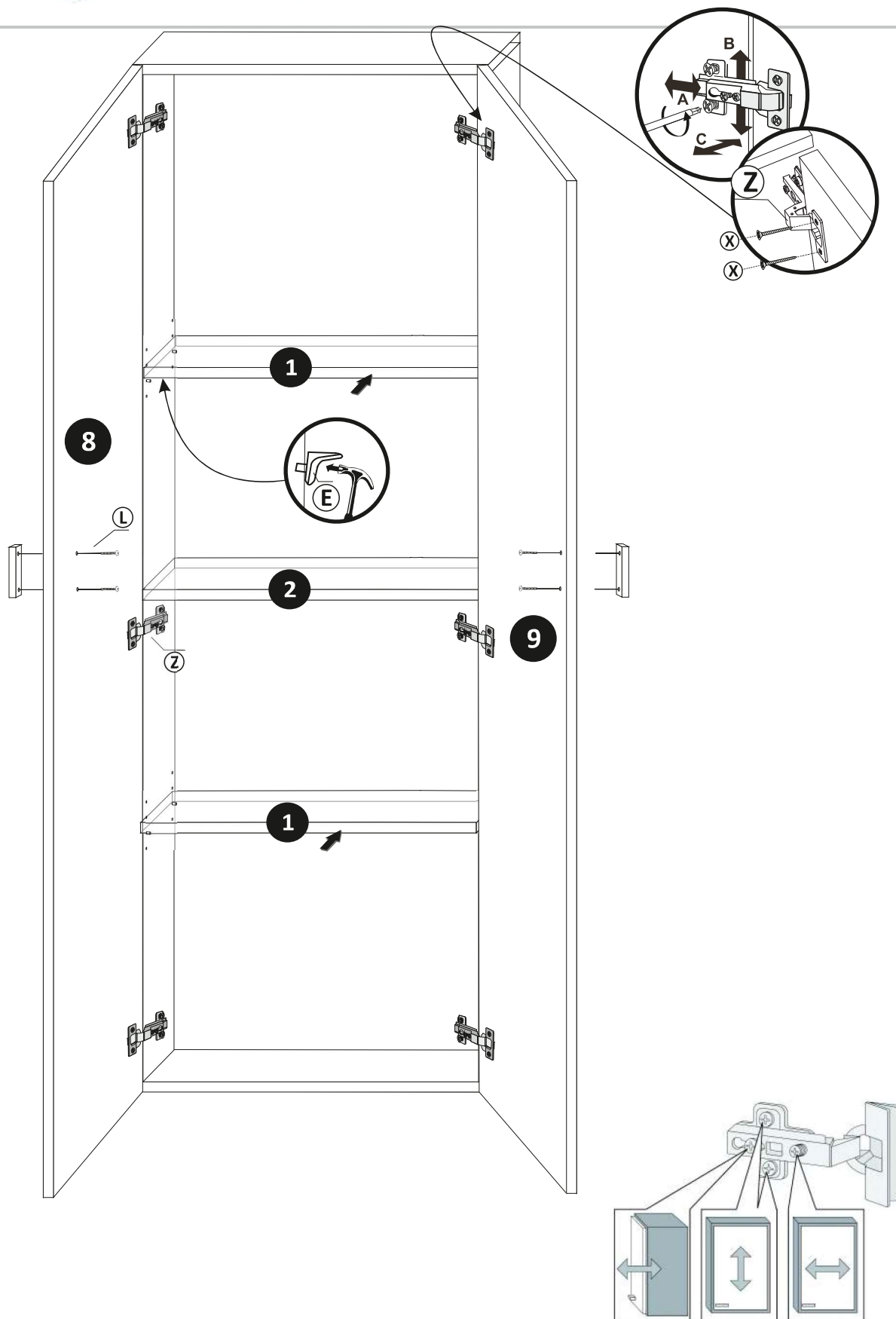

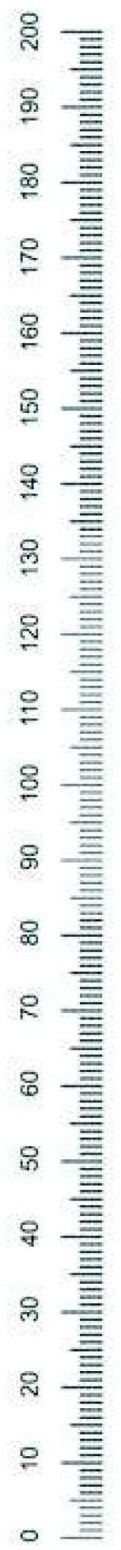
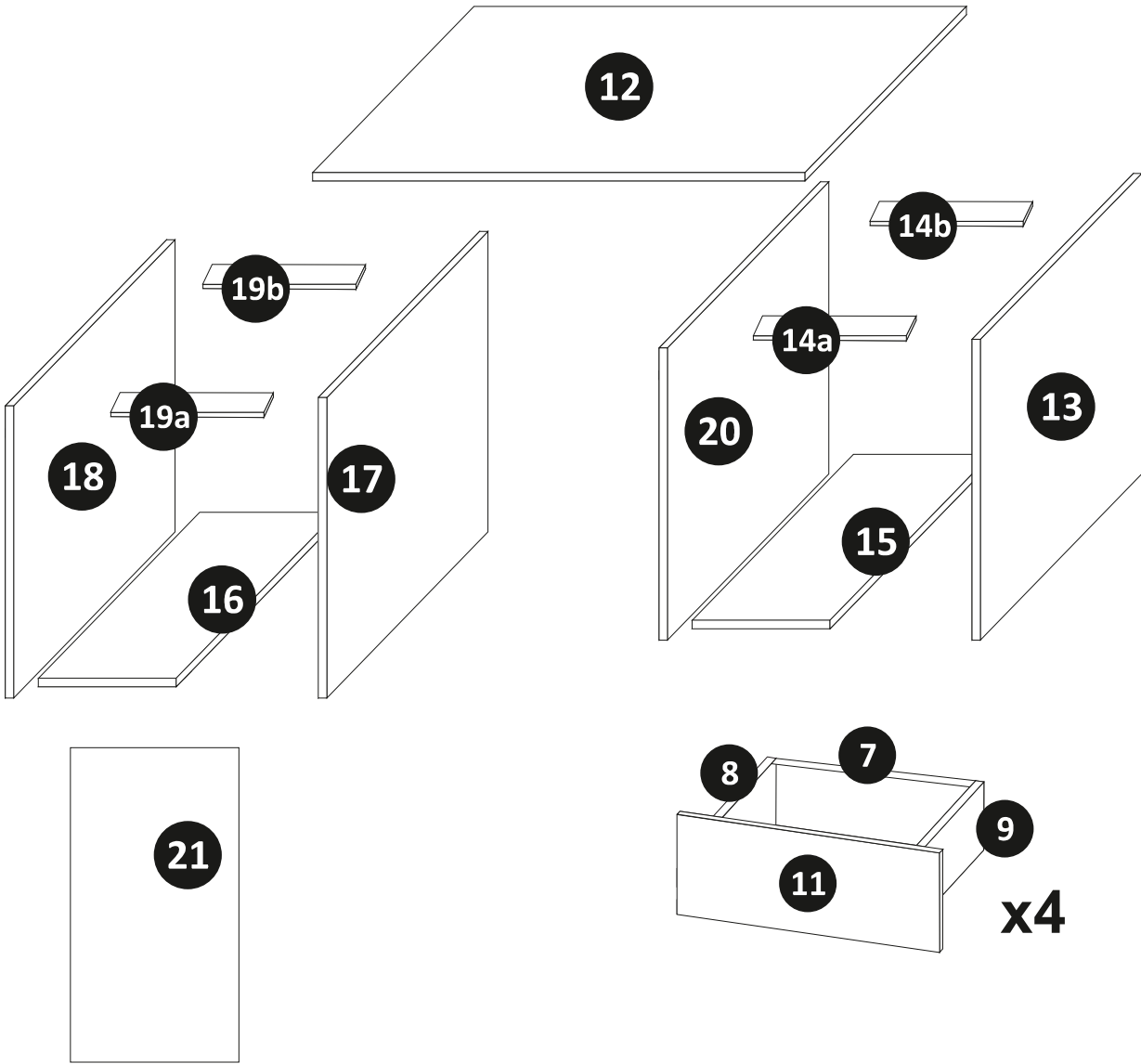

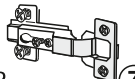

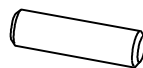

2





- | | | | | | | | | | | | | | |
|-------------|---|-----|---|--------------|---|--------------|---|------|--|------|---|------|---|
| 5x25
x 8 |  H | x 2 |  Z | 4x16
x 20 |  X | 5x13
x 16 |  R | x 40 |  G | x 32 |  A | x 4 |  Y |
| x 8 | | | | 4x30
x 10 |  L | x 16 |  F | x 16 |  B | x 16 |  C | x 16 |  K |

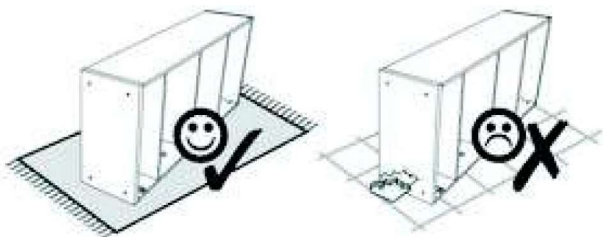

1

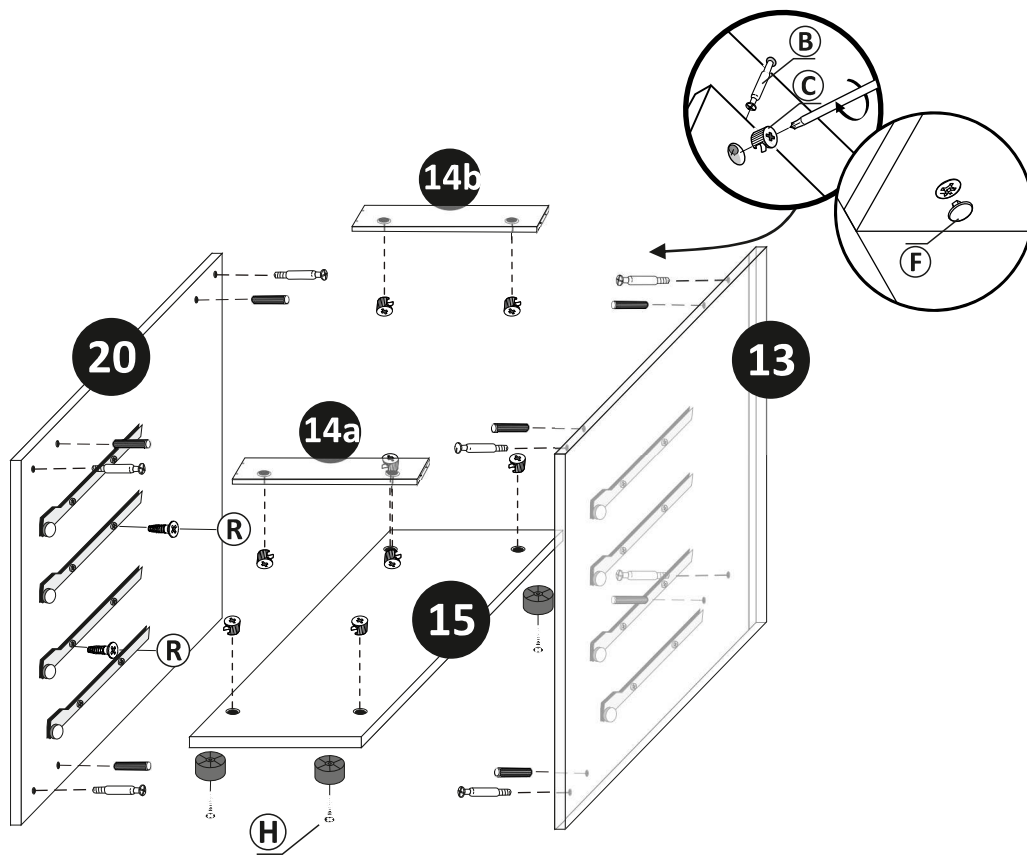

2

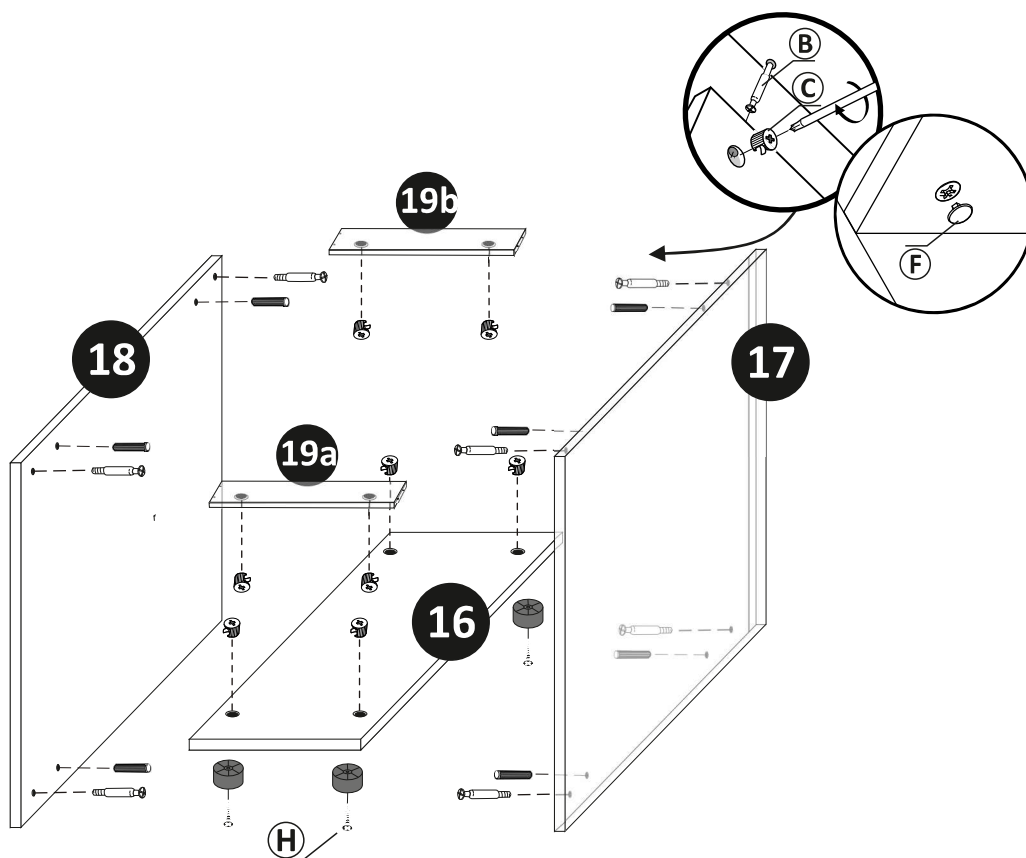

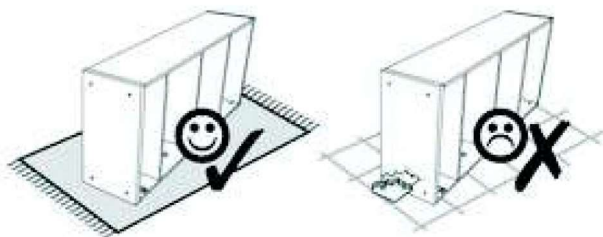

3

