

# 2D

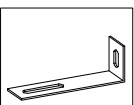

L19

1

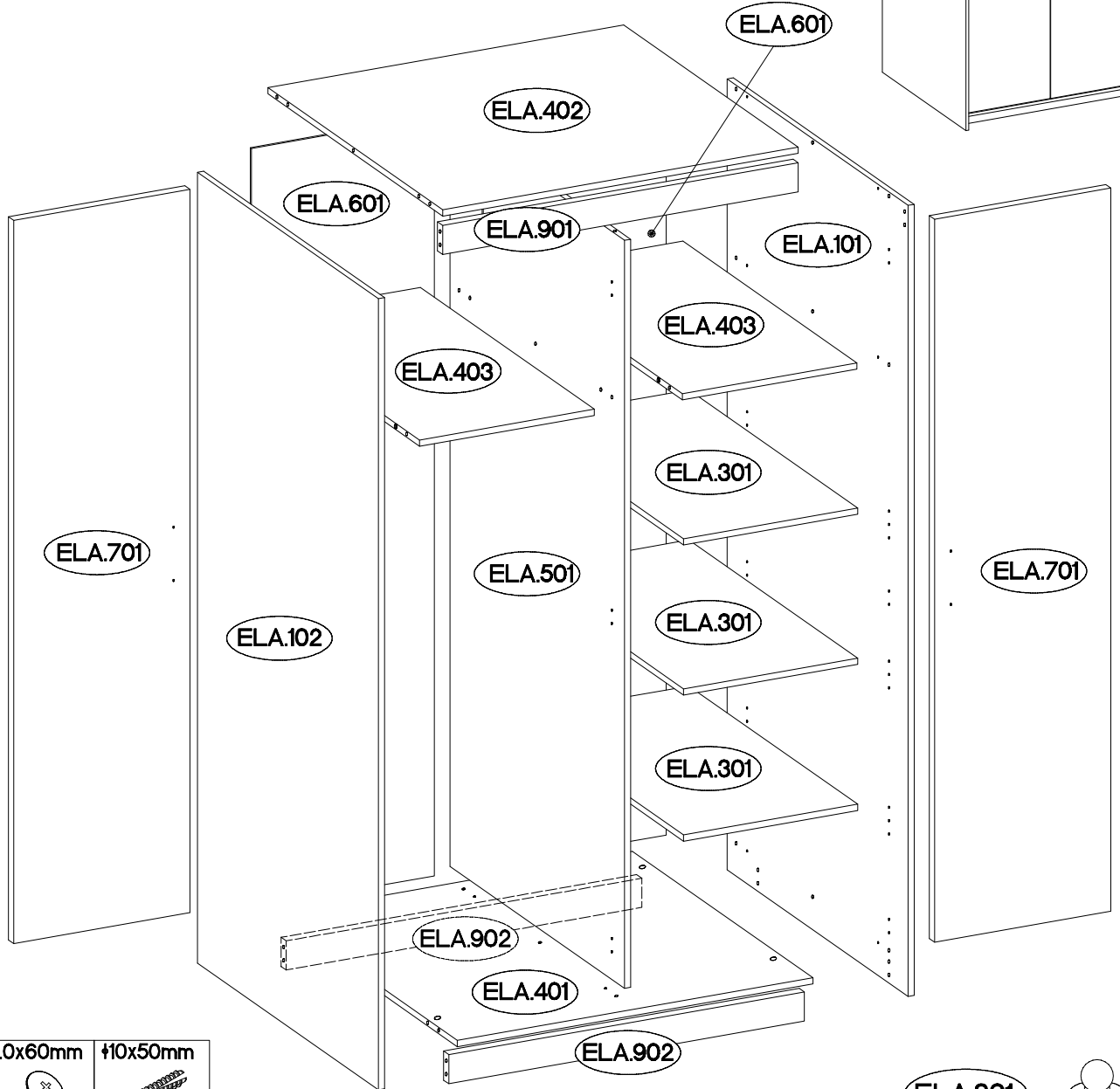
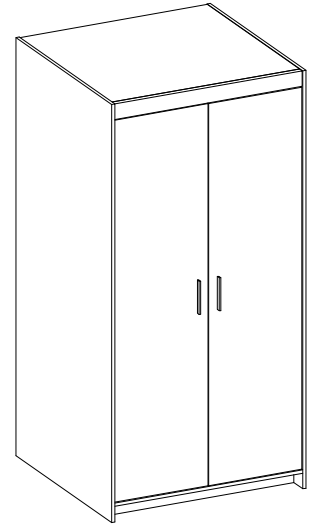
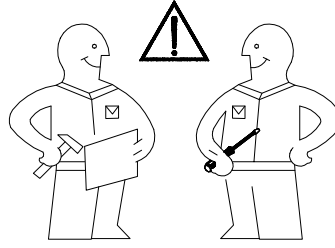
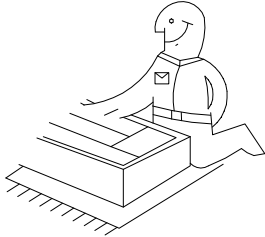
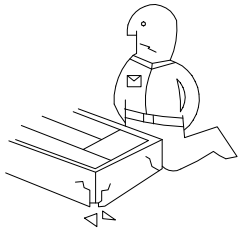
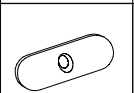

L2

14

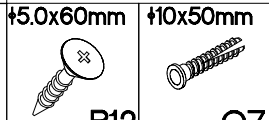

P12

1



O7

1

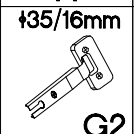

G2

6

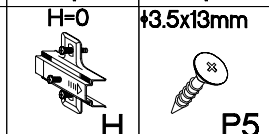

H

6



P5

16

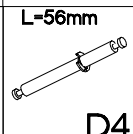

D4

2

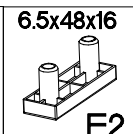

F2

4

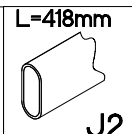

J2

1

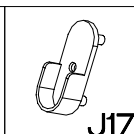

J17

2

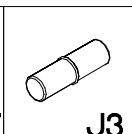

J3

12



C

20

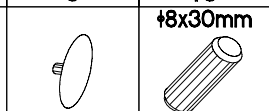

E

20

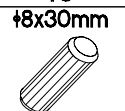

A

42



D2

16

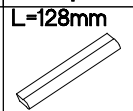

S11

2



R1

4



P7

57





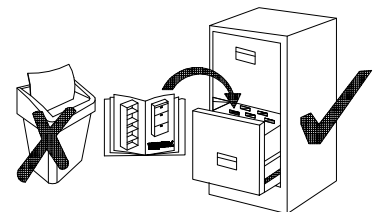
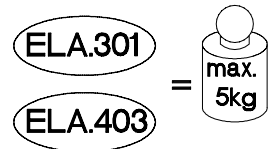

F4

2



P-ISM-ELA-01

1

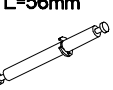
 #15/12mm C	 #8x30mm A	 L=20mm D2	 #15x5mm F4	 6.5x48x16 F2	 L=56mm D4
16	42	12	2	4	2

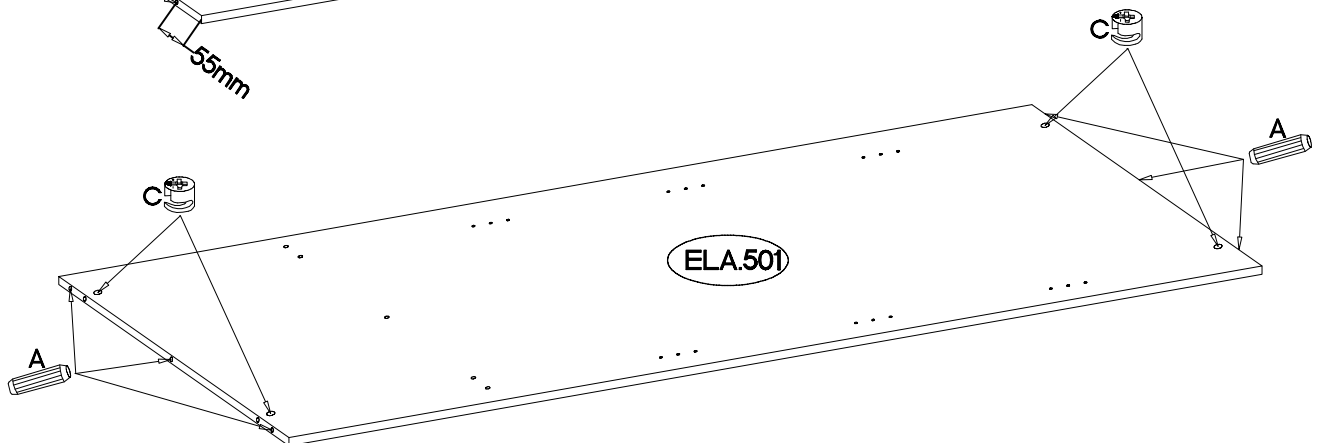
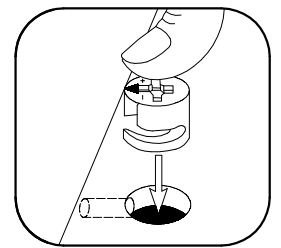
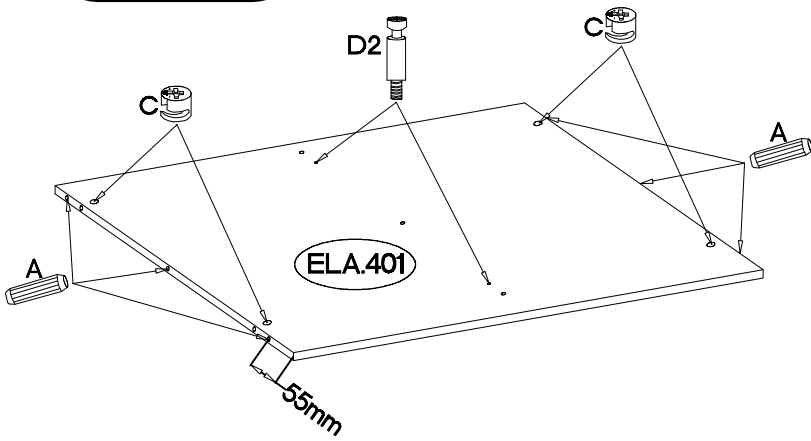
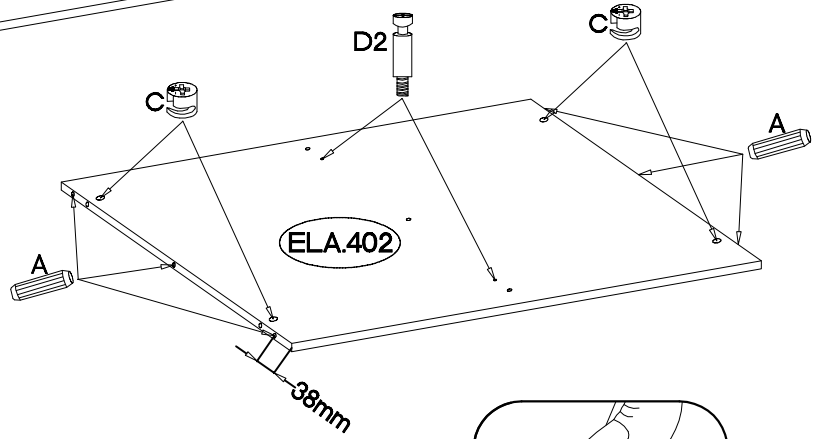
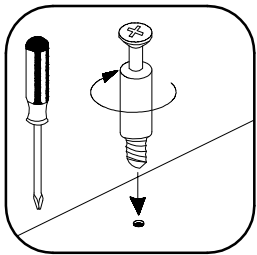
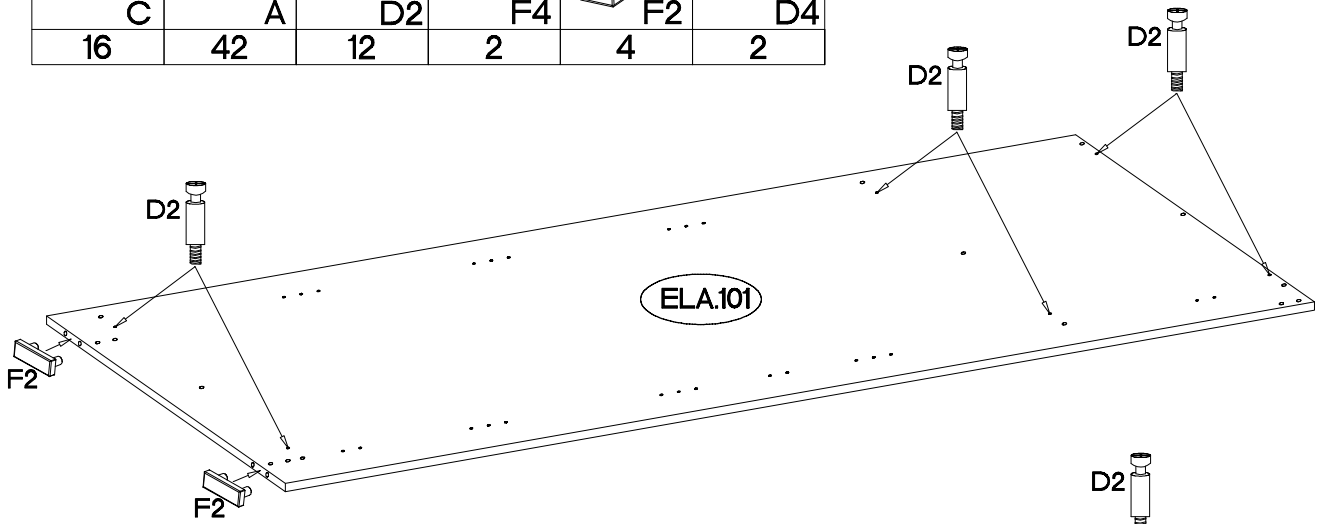

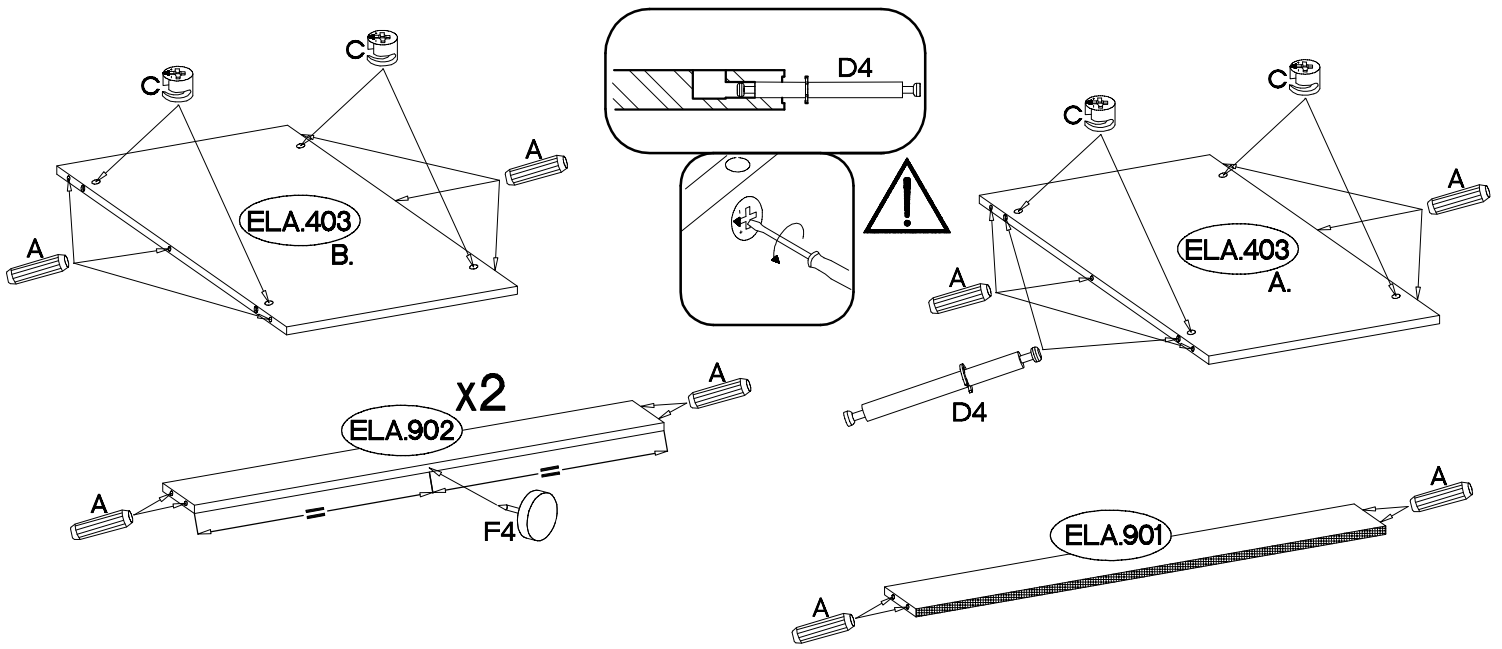

2

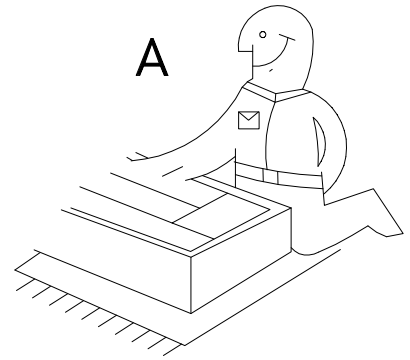
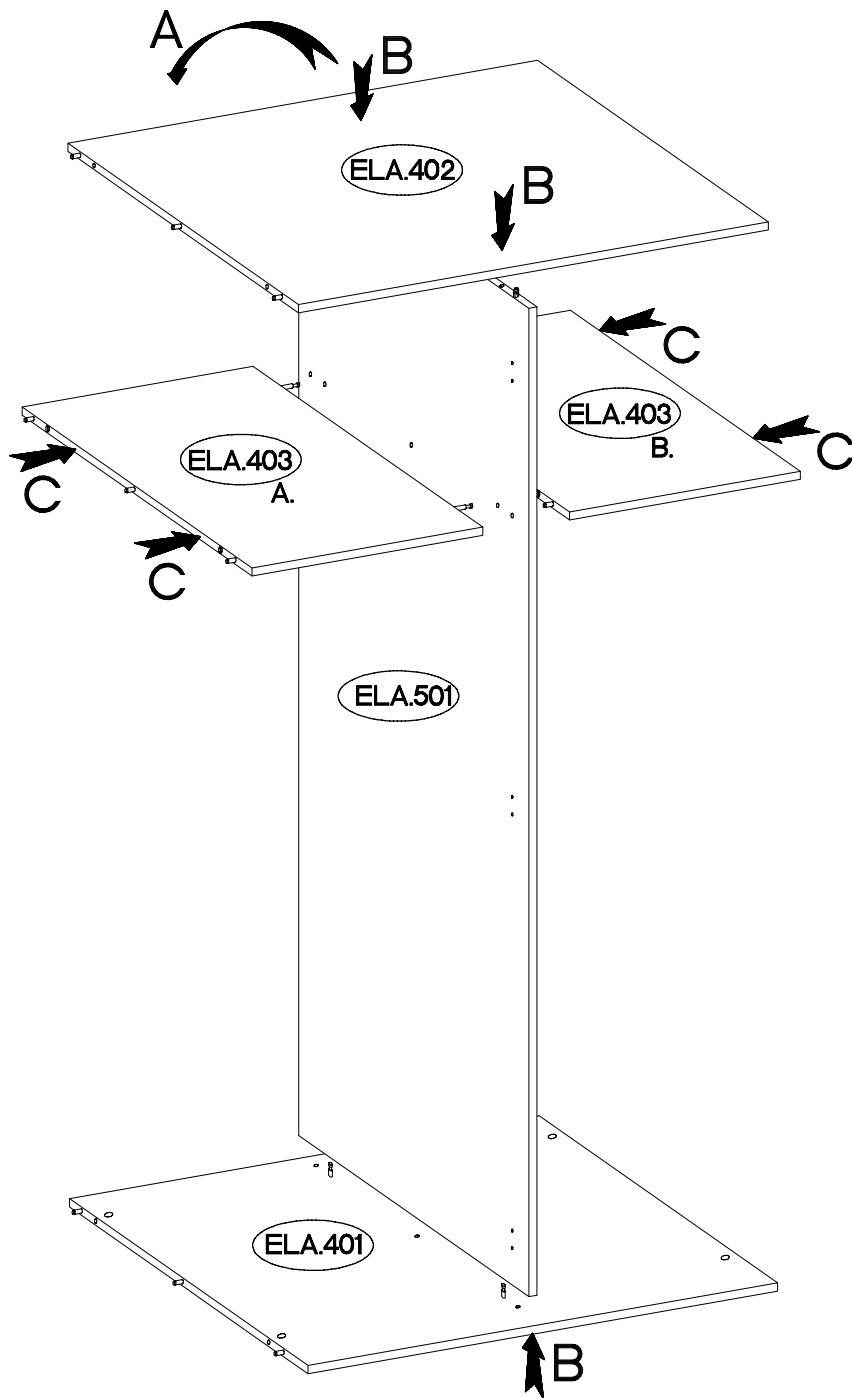

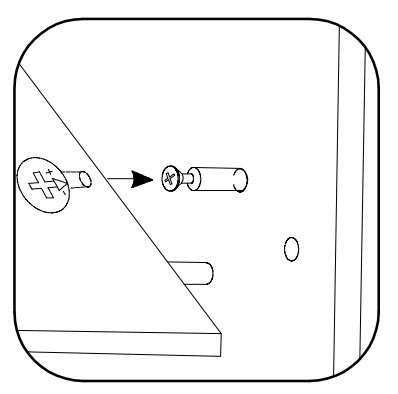
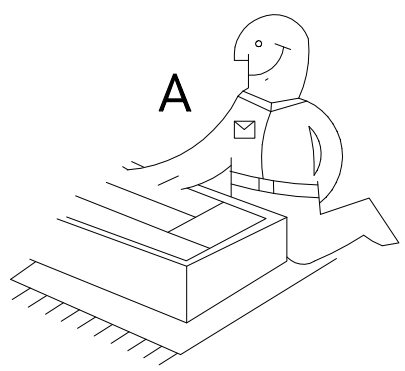
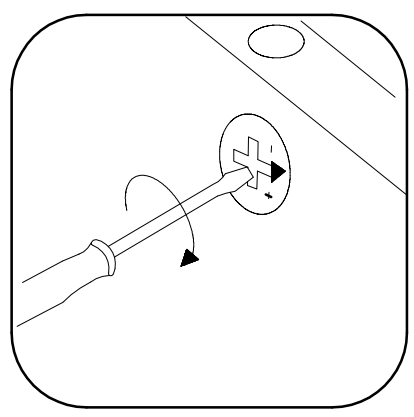
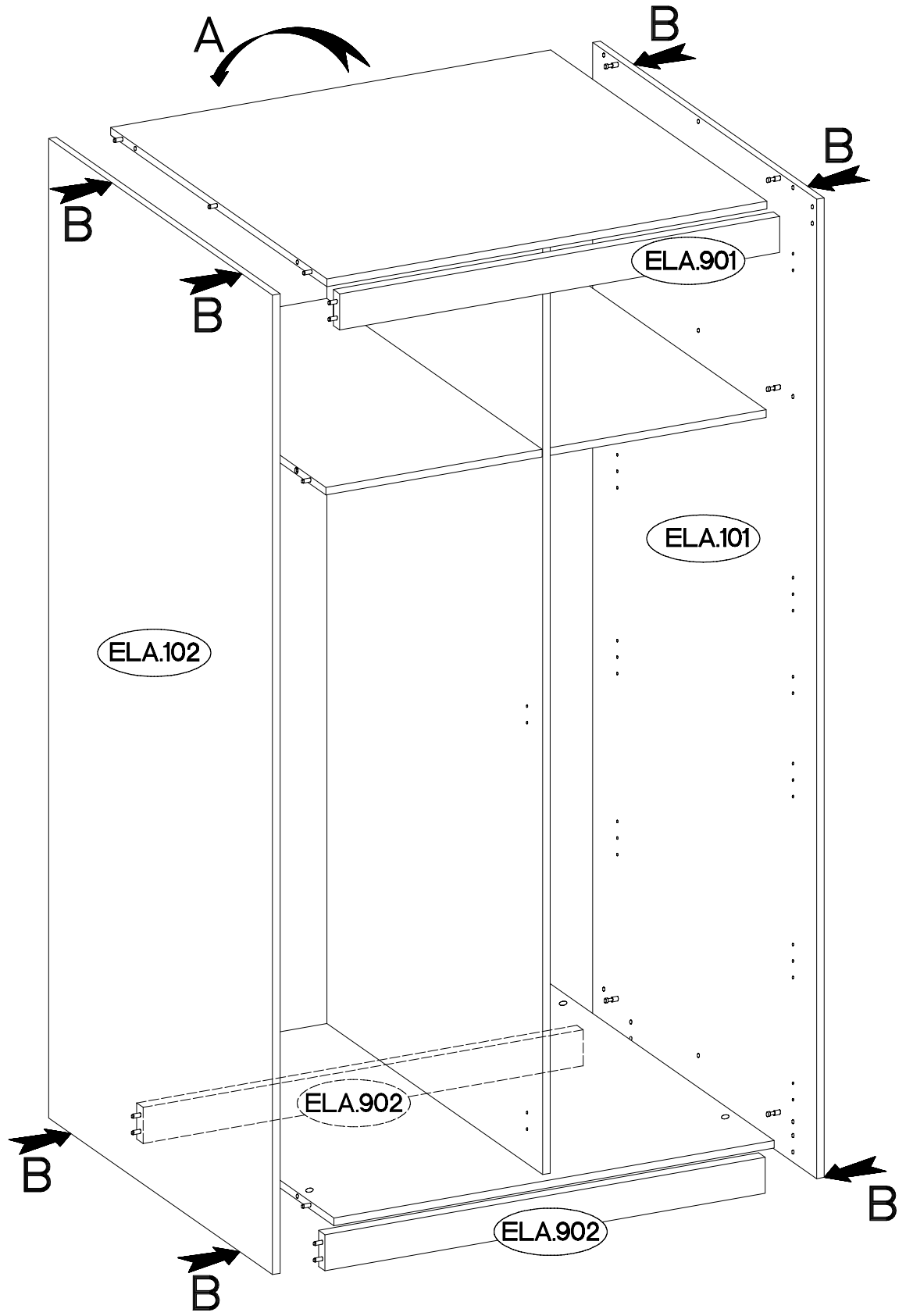



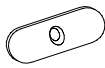

4

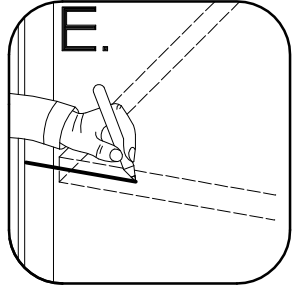
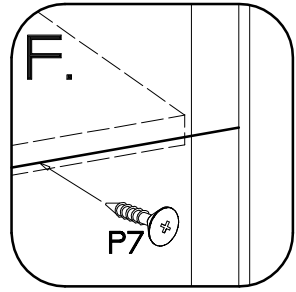
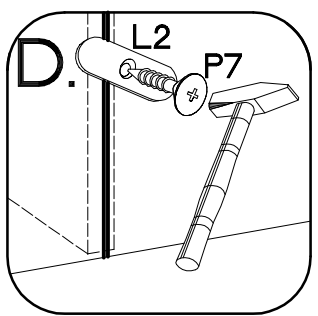
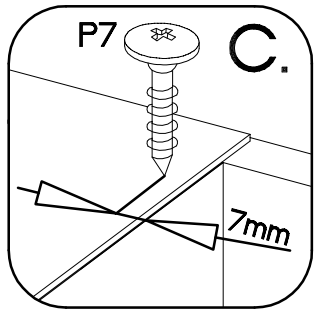
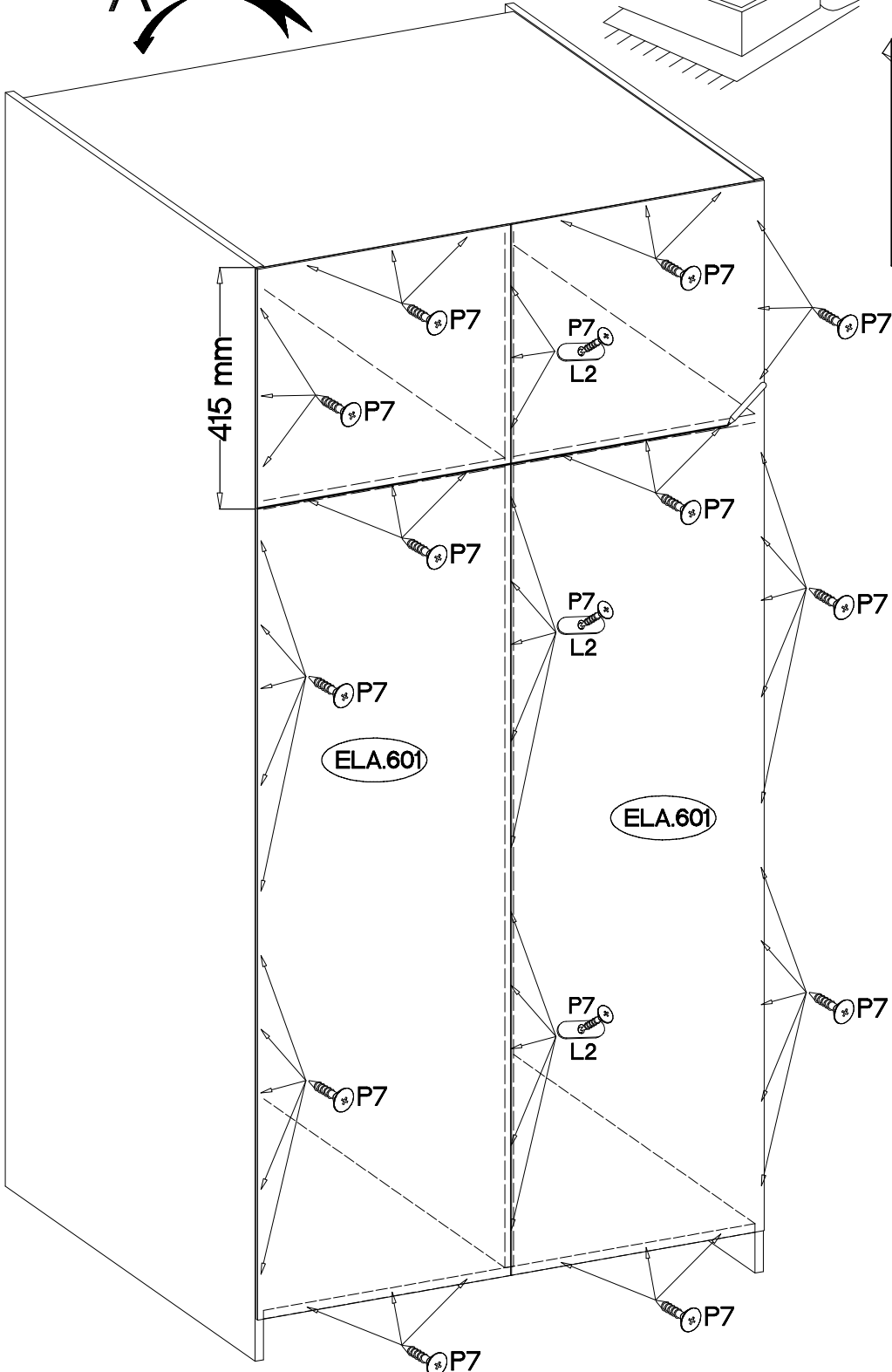
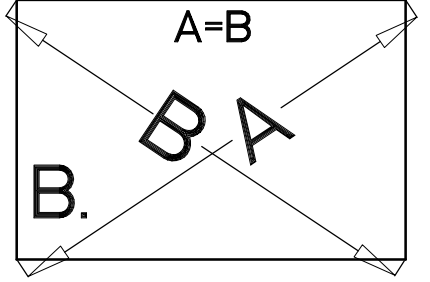
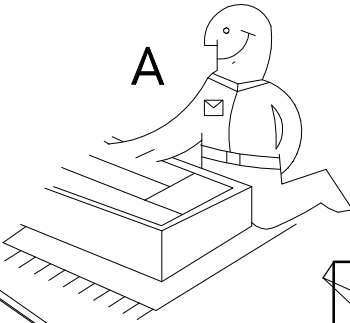
A

	#3.0x20mm
L2	P7
14	57





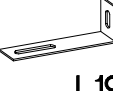

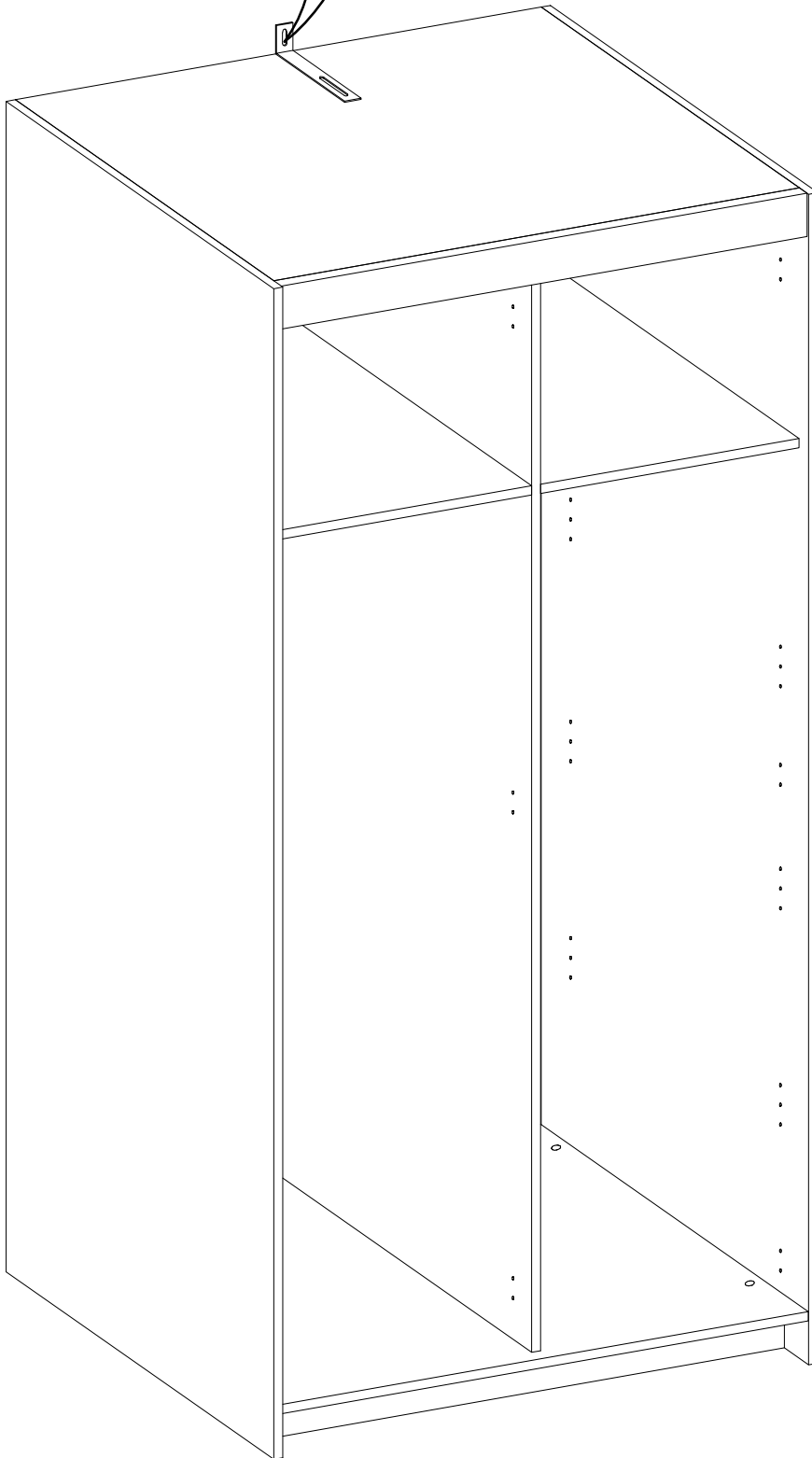
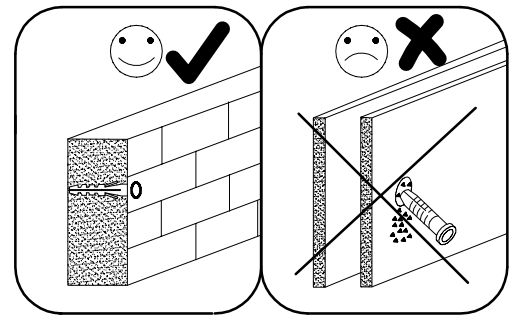
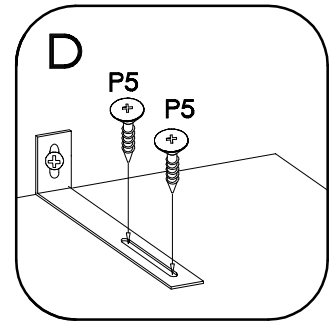
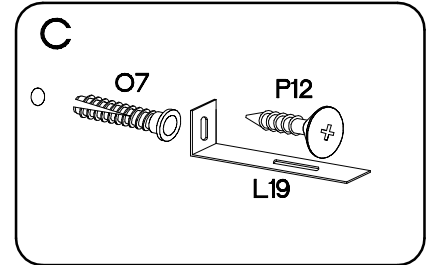
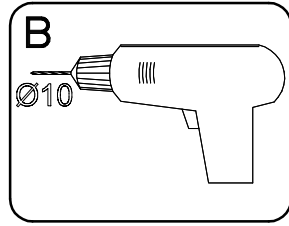
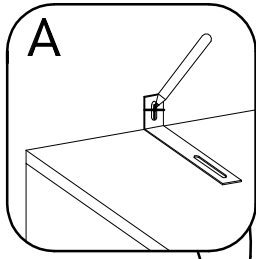
5

 P12 1	 O7 1	 P5 2	 L19 1
--	---	---	--



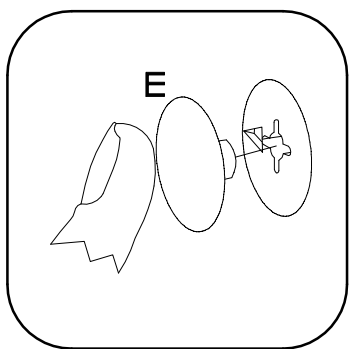
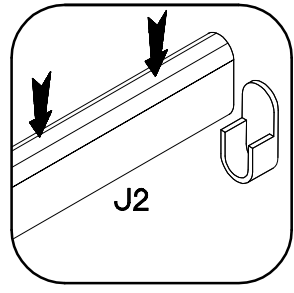
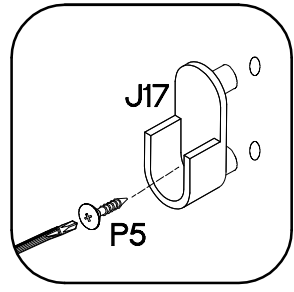
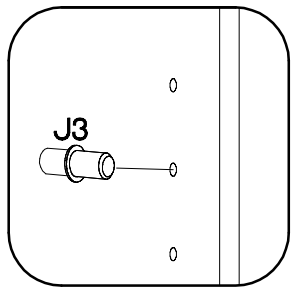
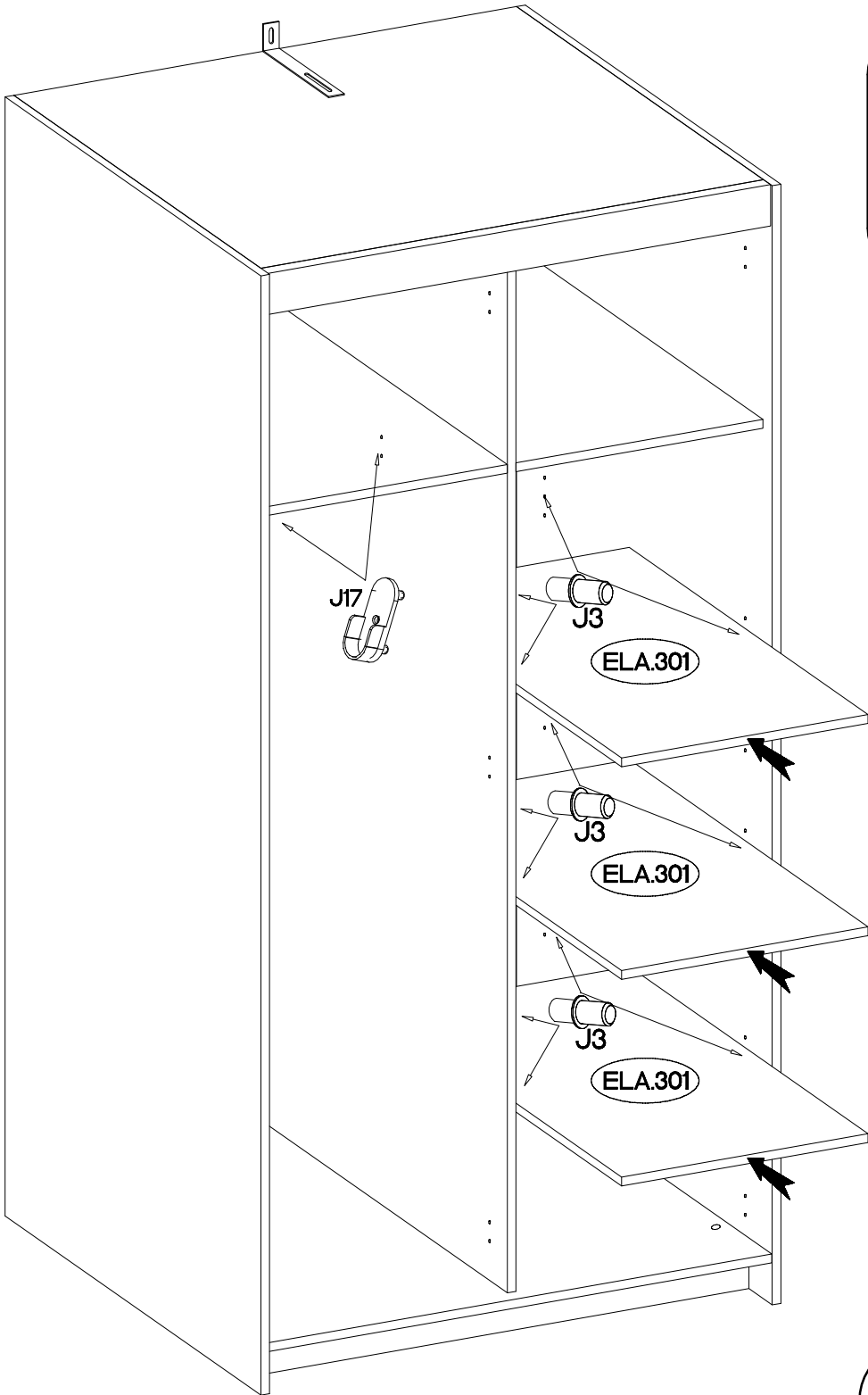

6

				
J3	E	J2	J17	P5
12	16	1	2	2



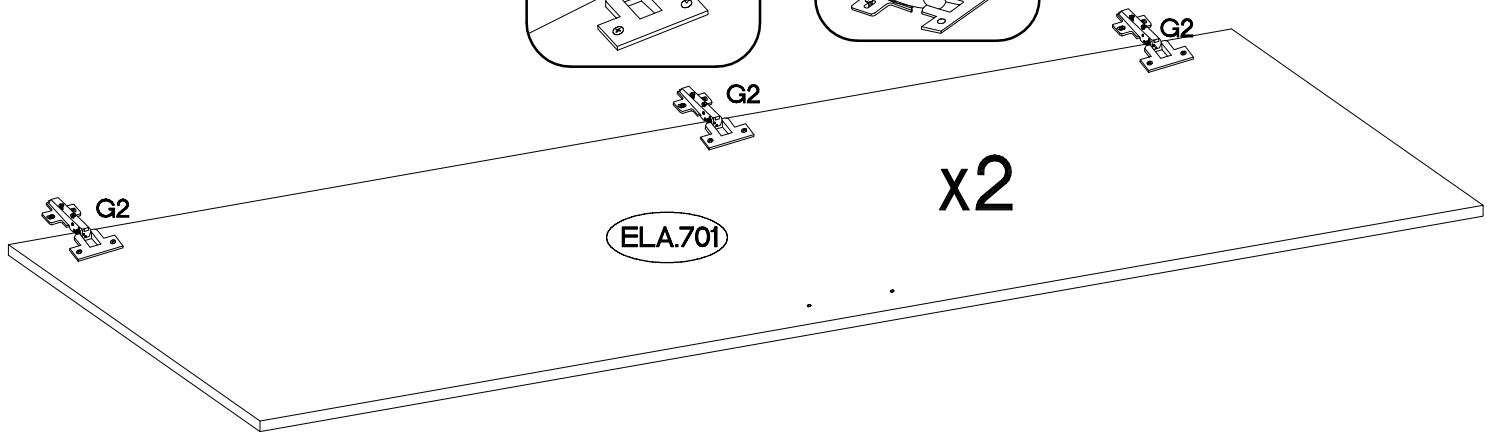
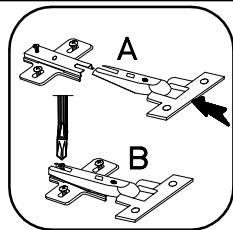
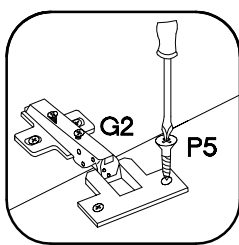

7

±35/16mm  G2 6	H=0  H 6	±3.5x13mm  P5 12
---	---	---

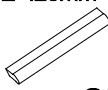

8

L=128mm  S11 3	±4.0x27mm  R1 6
--	---

